

Safety Summary

The following safety precautions apply to both operating and maintenance personnel and must be observed during all phases of operation, service, and repair of this instrument. Before applying power, follow the installation instructions and become familiar with the operating instructions for this instrument.

If this device is damaged or something is missing, contact the place of purchase immediately.

This manual contains information and warnings must be followed to ensure safe operation as well as to maintain the oscilloscope in a safe condition.

GROUND THE INSTRUMENT

To minimize shock hazard, the instrument chassis and cabinet must be connected to an electrical ground. This instrument is grounded through the ground conductor of the supplied, three-conductor ac power cable. The power cable must be plugged into an approved three-conductor electrical outlet. Do not alter the ground connection. Without the protective ground connection, all accessible conductive parts (including control knobs) can render an electric shock. The power jack and mating plug of the power cable meet IEC safety standards.

DO NOT OPERATE IN AN EXPLOSIVE ATMOSPHERE

Do not operate the instrument in the presence of flammable gases or fumes. Operation of any electrical instrument in such an environment constitutes a definite safety hazard.

KEEP AWAY FROM LIVE CIRCUITS

Instrument covers must not be removed by operating personnel. Component replacement and internal adjustments must be made by qualified maintenance personnel. Disconnect the power cord before removing the instrument covers and replacing components. Under certain conditions, even with the power cable removed, dangerous voltages may exist. To avoid injuries, always disconnect power and discharge circuits before touching them.

DO NOT SERVICE OR ADJUST ALONE

Do not attempt any internal service or adjustment unless another person, capable of rendering first aid and resuscitation, is present.

DO NOT SUBSTITUTE PARTS OR MODIFY THE INSTRUMENT

Do not install substitute parts or perform any unauthorized modifications to this instrument. Return the instrument to B&K Precision for service and repair to ensure that safety features are maintained.

WARNINGS AND CAUTIONS

WARNING and **CAUTION** statements, such as the following examples, denote a hazard and appear throughout this manual. Follow all instructions contained in these statements.

A **WARNING** statement calls attention to an operating procedure, practice, or condition, which, if not followed correctly, could result in injury or death to personnel.

A **CAUTION** statement calls attention to an operating procedure, practice, or condition, which, if not followed correctly, could result in damage to or destruction of part or all of the product.

WARNING: *Do not alter the ground connection. Without the protective ground connection, all accessible conductive parts (including control knobs) can render an electric shock. The power jack and mating plug of the power cable meet IEC safety standards.*

WARNING: *To avoid electrical shock hazard, disconnect power cord before removing covers. Refer servicing to qualified personnel.*

CAUTION: *Before connecting the line cord to the AC mains, check the rear panel AC line voltage indicator. Applying a line voltage other than the indicated voltage can destroy the AC line fuses. For continued fire protection, replace fuses only with those of the specified voltage and current ratings.*

CAUTION: *This product uses components which can be damaged by electro-static discharge (ESD). To avoid damage, be sure to follow proper procedures for handling, storing and transporting parts and subassemblies which contain ESD-sensitive components.*

Compliance Statements

Disposal of Old Electrical & Electronic Equipment (Applicable in the European Union and other European countries with separate collection systems)

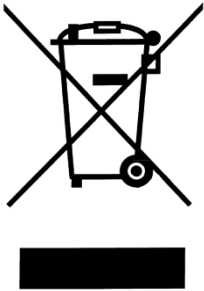

This product is subject to Directive 2002/96/EC of the European Parliament and the Council of the European Union on waste electrical and electronic equipment (WEEE) , and in jurisdictions adopting that Directive, is marked as being put on the market after August 13, 2005, and should not be disposed of as unsorted municipal waste. Please utilize your local WEEE collection facilities in the disposition of this product and otherwise observe all applicable requirements.

Safety Symbols



This symbol is used to denote the measurement ground connection.



This symbol on an instrument indicates caution. For details, the user should refer to the operating instructions in the manual.



Electrical Shock hazard.



On (Power). This is the In position of the power switch when instrument is ON.



Off (Power). This is the Out position of the power switch when instrument is OFF.



This symbol shows that the switch is a power switch located at the top of the oscilloscope. Pressing this button toggles the oscilloscope's state between operation and power off mode.

**CAT I
(400V)**

IEC Measurement Category I.
Inputs may be connected to
mains (up to 400 VAC) under
Category I overvoltage conditions.

Table of Contents

SAFETY SUMMARY.....	3
CHAPTER 1 INTRODUCTION.....	10
PANEL AND DISPLAY INFORMATION	11
<i>Front Panel.....</i>	<i>11</i>
<i>Back and Side Panel</i>	<i>12</i>
<i>Display Information</i>	<i>15</i>
CHECKING FUNCTIONS	17
PROBE SAFETY	19
PROBE ATTENUATION	20
PROBE COMPENSATION.....	20
CHAPTER 2 FUNCTIONS AND OPERATING DESCRIPTIONS	22
MENU AND CONTROL BUTTON	23
CONNECTORS	25
AUTO SETUP.....	26
DEFAULT SETUP	29
UNIVERSAL KNOB	30
VERTICAL SYSTEM.....	31
CHANNEL FUNCTION MENU	32
<i>Setting Up Channels.....</i>	<i>34</i>
USING VERTICAL POSITION KNOB AND VOLT/DIV KNOB.....	41
MATH FUNCTIONS.....	42
<i>FFT Spectrum Analyzer.....</i>	<i>44</i>
<i>Displaying the FFT Spectrum.....</i>	<i>47</i>
<i>Select FFT Window.....</i>	<i>48</i>
<i>Magnifying and Positioning and FFT Spectrum</i>	<i>49</i>
<i>Measuring an FFT Spectrum Using Cursors</i>	<i>49</i>
USING REF.....	53
HORIZONTAL SYSTEM.....	55
<i>Horizontal Control Knob.....</i>	<i>55</i>
<i>Window Zone.....</i>	<i>57</i>
TRIGGER SYSTEM.....	58
<i>Signal Source.....</i>	<i>60</i>

<i>Trigger Type</i>	60
<i>Coupling</i>	80
<i>Position</i>	80
<i>Slope and Level</i>	80
<i>Trigger Holdoff</i>	81
ACQUIRING SIGNALS SYSTEM	83
DISPLAY SYSTEM	90
<i>X-Y Format</i>	96
MEASURE SYSTEM.....	98
<i>Scale Measurement</i>	98
<i>Cursor Measurement</i>	98
<i>Auto Measurement</i>	104
STORAGE SYSTEM.....	113
UTILITY SYSTEM	132
<i>System Status</i>	135
<i>Language</i>	136
<i>Self Calibration</i>	137
<i>Self Test</i>	138
<i>Updating the System Software</i>	141
<i>Pass/Fail</i>	142
<i>Waveform Recorder</i>	148
<i>Record</i>	152
ONLINE HELP FUNCTION.....	156
CHAPTER 3 APPLICATION EXAMPLES	158
TAKING SIMPLE MEASUREMENTS.....	159
TAKING CURSOR MEASUREMENTS	161
MEASURING RING FREQUENCY	161
<i>Measuring Ring Amplitude</i>	162
CAPTURE A SINGLE EVENT	163
ANALYZING THE SIGNAL DETAIL	165
<i>Looking at a Noisy Signal</i>	165
<i>Separating the Signal from Noise</i>	165
TRIGGERING ON A VIDEO SIGNAL	166
<i>Triggering on Video Field</i>	166
<i>Triggering on Video Lines</i>	167
APPLICATION OF X-Y FUNCTION.....	167

ANALYZING A DIFFERENTIAL COMMUNICATION SIGNAL	169
CHAPTER 4 MESSAGE PROMPTS AND TROUBLESHOOTING.....	171
MESSAGE PROMPTS	171
TROUBLESHOOTING	173
CHAPTER 5 SPECIFICATIONS	176
SPECIFICATIONS.....	176
CERTIFICATION.....	182
APPENDIX A DEFAULT SETUP.....	183
APPENDIX B INDEX	186
APPENDIX C DISABLING AUTO FUNCTION.....	187
SERVICE INFORMATION	188
LIMITED ONE-YEAR WARRANTY	189

Chapter 1 Introduction

The 2530B digital storage oscilloscope (DSO) is a portable benchtop instrument used for making measurements of signals and waveforms. This chapter will highlight information on the following:

- Panel and display information
- Checking functions
- Probe Attenuation
- Probe Compensation

Panel and Display Information

Front Panel

It is important for you to understand the DSO's front panel before operating it. The following contents are a brief introduction for the front panel function, which is useful to become familiar with the operation of the 2530B DSO.

The oscilloscope provides an easy-to-use front panel to simplify operations for the user

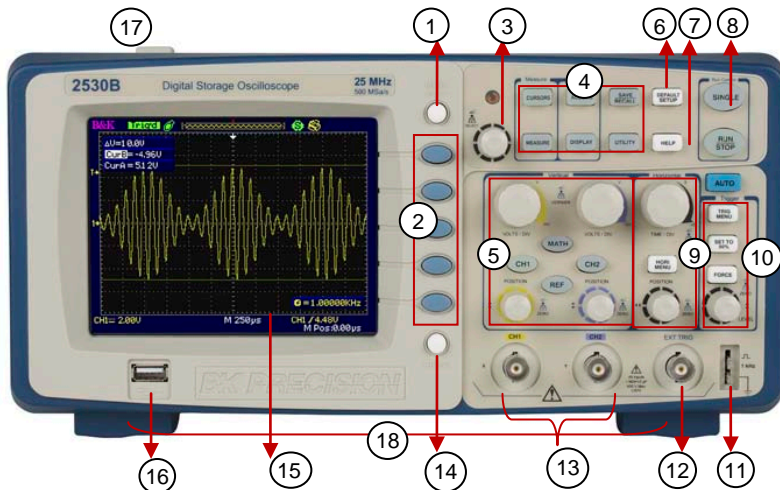

Figure 1 - Front Panel Controls

1. Menu On/Off display button
2. Selection option buttons
3. Universal knob
4. Common function buttons (Cursor, Measure, Acquire, Display, Save/Recall, Utility)
5. Vertical Controls (Volts/div, vertical position, CH1 & CH2 On/Off, Math function, Reference function)
6. Default setup button
7. Help button
8. Run Controls (Single, Run/Stop)
9. Horizontal Controls (Time/div, horizontal position, Horizontal menu)
10. Trigger Controls (Trigger menu, Set to 50%, Force, Trigger level)
11. 1 kHz probe compensation
12. External trigger
13. CH1 and CH2 inputs
14. Print button
15. LCD Display
16. USB Host port (for storage to USB thumb drives)
17. Main power On/Off button
18. Tilt feet

Back and Side Panel

The following shows the back and side panel connections of the DSO.

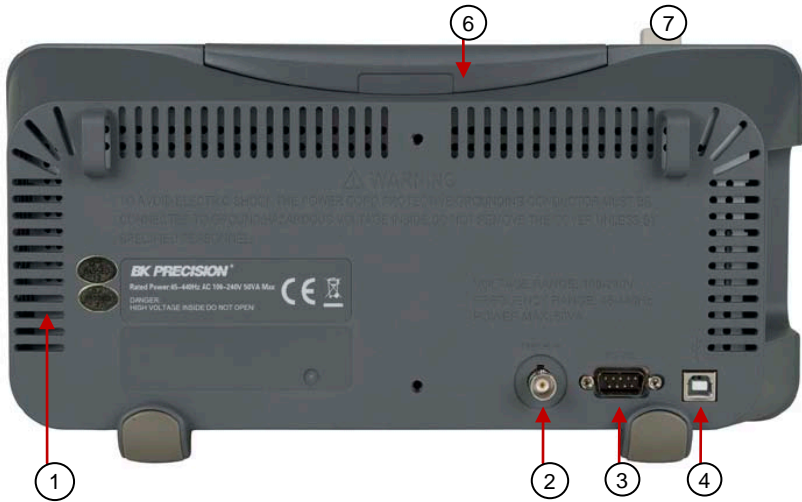

Figure 2 - Back Panel

1. Side ventilation fan
2. Pass/Fail output
3. RS-232 Port
4. USB interface port (for remote connection to EasyScope software)
5. AC line input (100~240 V, 45-440 Hz, max. 50 VA)
6. Carrying handle
7. Main power On/Off button



Figure 3 - Side Panel

Display Information

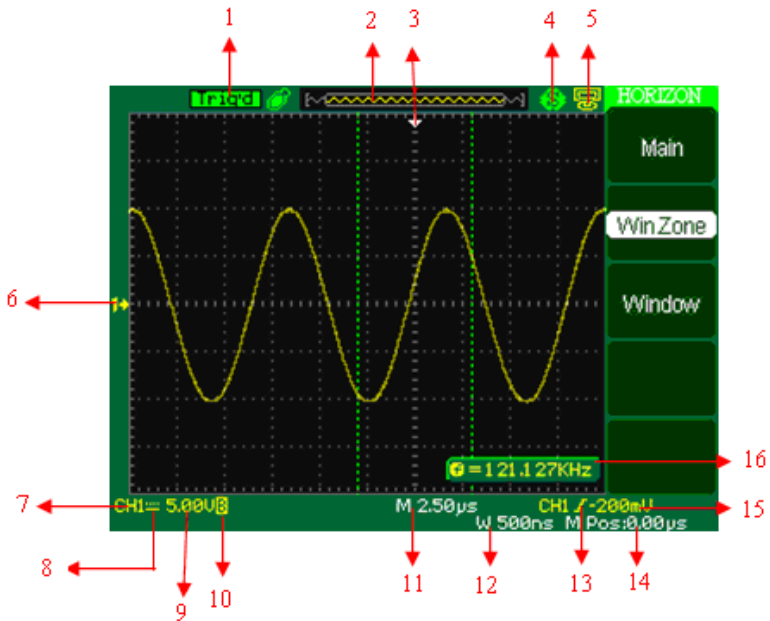





Figure 4 - Display Screen

1. Trigger status

- Armed - The oscilloscope is acquiring pre-trigger data. All triggers are ignored in this state.
- Ready - All pre-trigger data has been acquired and the oscilloscope is ready to accept a trigger.
- Trig'd - The oscilloscope has seen a trigger and is acquiring the post-trigger data.
- Stop - The oscilloscope has stopped acquiring waveform data.
- Auto - The oscilloscope is in auto mode and is acquiring waveforms in the absence of triggers.
- Scan - The oscilloscope is acquiring and displaying waveform data continuously in scan mode. This mode

occurs when oscilloscope is looking for a signal or when timebase is set slow enough in which the scope requires longer time to “scan” in order to acquire the entire signal on display.

2. Displays position of the present waveform window in internal memory.
3. Marker shows horizontal trigger position. Turn the **HORIZONTAL POSITION KNOB** to adjust the position of the marker.
4. Print Key – Indicates whether the **PRINT KEY** option is set to print picture or save picture.
 -  “Print Key” option is set to “Print Picture”
 -  “Print Key” option is set to “Save Picture”
5. Back USB – Indicates whether the **BACK USB** option is set to Computer or Printer.
 -  “Back USB” option is set to “Computer”.
 -  “Back USB” option is set to “Printer” (not available)
6. Tag to show waveform channel number.
7. On-screen markers show the ground reference points of the displayed waveforms. If there is no marker, the channel is not displayed. Display signal source.
8. Signal Coupling Symbol
9. Vertical scale factor of corresponding channels.
10. Indicates whether the bandwidth limiting filter is “On” or “Off”. The “B” icon indicates the filter is On.
11. Main time base scale setting
12. Horizontal position of main time base waveform.
13. Shows the icon for the trigger type
14. Displays real time and date
15. Shows the trigger voltage
16. Trigger signal frequency

Checking Functions

Please follow the steps below when checking the oscilloscope's functionality.

1. Power on the oscilloscope.

Press "DEFAULT SETUP" to show the result of the self check.

The probe default attenuation is 1X.

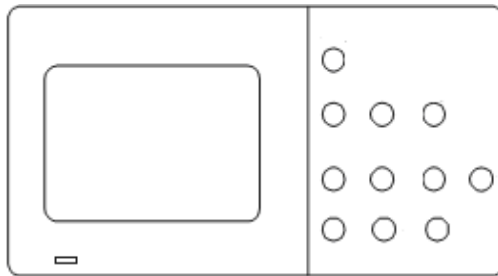

Figure 5 - Scope Layout

2. Set the switch to 1X on the probe and connect the probe to channel 1 on the oscilloscope. To do this, align the slot in the probe connector with the key on the CH 1 BNC, push to connect, and twist to the right to lock the probe in place. Connect the probe tip and reference lead to the PROBE COMP connectors.

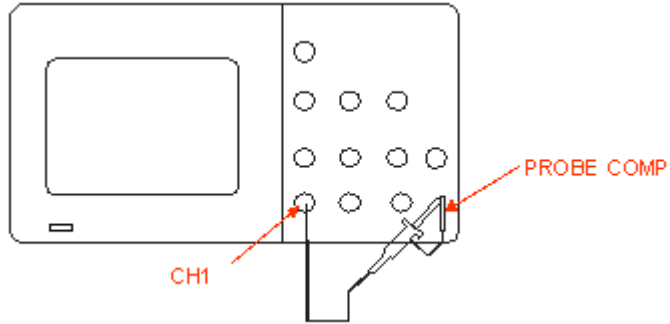

Figure 6 - Probe Compensation

3. Press "AUTO" to show the 1 kHz frequency and about 3V peak-peak square wave in couple seconds.

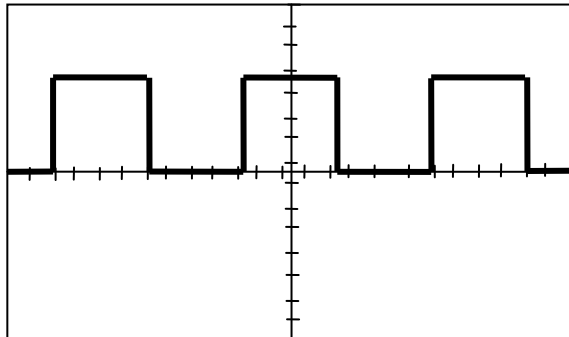

Figure 7 - 3Vpp Square Wave

4. Press "CH1" two times to cancel the channel 1, Press "CH2" to change screen into channel 2, reset the channel 2 as step 2 and step 3.

Probe Safety

A guard around the probe body provides a finger barrier for protection from electric shock.

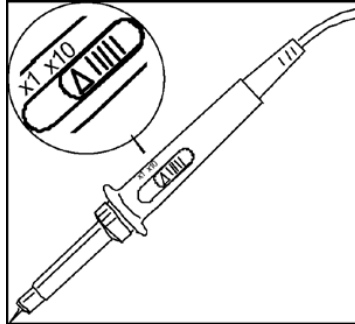

Figure 8 - Probe

Connect the probe to the oscilloscope and connect the ground terminal to ground before you take any measurements.

- Note:** ● To avoid electric shock when using the probe, keep fingers behind the guard on the probe body.
- To avoid electric shock while using the probe, do not touch metallic portions of the probe head while it is connected to a voltage source. Connect the probe to the oscilloscope and connect the ground terminal to ground before you take any measurements.

Probe Attenuation

Probes are available with various attenuation factors which affect the vertical scale of the signal. The Probe Check function verifies that the Probe attenuation option matches the attenuation of the probe.

You can push a vertical menu button (such as the CH 1 MENU button), and select the Probe option that matches the attenuation factor of your probe.

Note. The default setting for the Probe option is 1X.

Be sure that the attenuation switch on the probe matches the Probe option in the oscilloscope. Switch settings are 1X and 10X.

Note. When the attenuation switch is set to 1X, the probe limits the bandwidth of the oscilloscope to 10 MHz (according to Probe spec). To use the full bandwidth of the oscilloscope, be sure to set the switch to 10X.

Probe Compensation

As an alternative method to Probe Check, you can manually perform this adjustment to match your probe to the input channel.

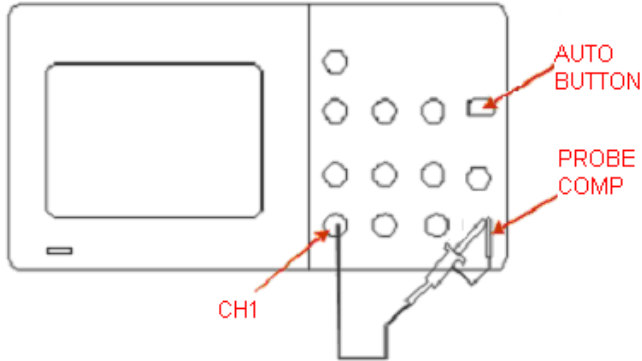
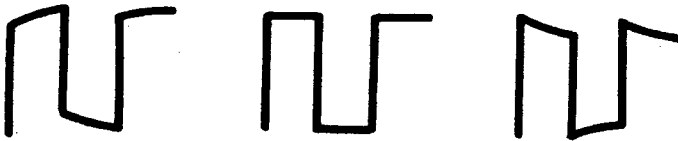

Figure 9 - Probe Compensation Setup

1. Set the Probe option attenuation in the channel menu to 10X. Do so by pressing CH1 button and selecting “Probe” from menu. Select 10X. Set the switch to 10X on the probe and connect the probe to channel 1 on the oscilloscope. If you use the probe hook-tip, ensure a proper connection by firmly inserting the tip onto the probe.
2. Attach the probe tip to the PROBE COMP 3V connector and the reference lead to the PROBE COMP Ground connector. Display the channel and then push the “AUTO” button.
3. Check the shape of the displayed waveform.



Overcompensated	Compensated Correctly	Undercompensated
-----------------	-----------------------	------------------

4. If necessary, adjust your probes compensation trimmer pot. Repeat as necessary.

Chapter 2 Functions and Operating Descriptions

To use your oscilloscope effectively, you need to learn about the following oscilloscope functions:

- Menu and control button
- Connector
- Auto Setup
- Default Setup
- Universal knob
- Vertical System
- Horizontal System
- Trigger System
- Acquiring signals System
- Display System
- Measuring waveforms System
- Utility System
- Storage System
- Online Help function

Menu and Control Button

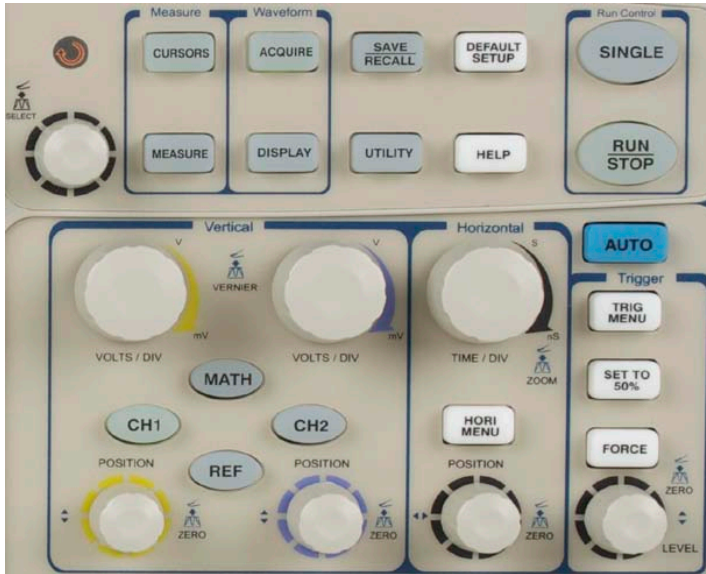

Figure 10 - Control Buttons

Channel buttons (CH1, CH2): Press a channel button (CH1 or CH2) to turn that channel ON or OFF and open the Channel menu for that channel. You can use the channel menu to set up a channel. When the channel is ON, the channel button is lit.

MATH: Press to display the Math menu. You can use the MATH menu to use the oscilloscope's Math functions.

REF: Press to display the Ref Wave menu. You can use this menu to save and recall reference waveforms to and from internal memory.

HORI MENU: Press to display the Horizontal menu. You can use the Horizontal menu to display the waveform and to zoom a segment of a waveform.

TRIG MENU: Press to display the Trigger menu. You can use the Trigger menu to set the trigger type (Edge, Pulse, Video, Slope, Alternative) and trigger settings.

SET TO 50%: Press to stabilize a waveform quickly. The oscilloscope can set the trigger level to be halfway between the minimum and maximum voltage level automatically. This is useful when you connect a signal to the EXT TRIG connector and set the trigger source to Ext or Ext/5.

FORCE: Use the FORCE button to complete the current waveform acquisition whether the oscilloscope detects a trigger or not. This is useful for Single acquisitions and Normal trigger mode.

SAVE/RECALL: Press to display the Save/Recall menu. You can use the Save/Recall menu to save and recall up to 20 oscilloscope setups and 10 waveforms to/from internal memory or a USB memory device (limited by memory capacity of USB device). You can also use it to recall the default factory settings, to save waveform data as a comma-delimited file (.CSV), and to save the displayed waveform image.

ACQUIRE: Press to display Acquire menu. You can use the Acquire menu to set the acquisition Sampling Mode (Sampling, Peak Detect, Average).

MEASURE: Press to display a menu of measurement parameters.

CURSORS: Display the Cursor Menu. Vertical Position controls adjust cursor position while displaying the Cursor Menu and the cursors are activated. Cursors remain displayed (unless the “Type” option is set to “Off”) after leaving the Cursor Menu but are not adjustable.

DISPLAY: Press to open the Display menu. You can use the Display menu to set grid and waveform display styles, and persistence.

UTILITY: Press to open the Utility menu. You can use the Utility menu to configure oscilloscope features, such as sound, language, counter, etc. You can also view system status and update software.

DEFAULT SETUP: Press to reset the oscilloscope's settings to the default factory configuration.

HELP: Enter the online help system.

AUTO: Automatically sets the oscilloscope controls to produce a usable display of the input signals.

RUN/STOP: Continuously acquires waveforms or stops the acquisition.

Note: If waveform acquisition is stopped (using the RUN/STOP or SINGLE button), the TIME/DIV control expands or compresses the waveform.

SINGLE: Acquire a single waveform and then stops.

Connectors



Figure 11 - Connectors

Channel Connector (CH1, CH2): Input connectors for waveforms display.

EXT TRIG: Input connector for an external trigger source. Use the Trigger Menu to select the “Ext” or “Ext/5” trigger source.

Probe Compensation: 1 kHz voltage probe compensation output and ground. Use to electrically match the probe to the oscilloscope input circuit.

Auto Setup

The 2530B Digital Storage Oscilloscope has an Auto Setup function that identifies the waveform types and automatically adjusts controls to produce a usable display of the input signal.

Press the AUTO front panel button, and then press the menu option button adjacent to the desired waveform as follows:

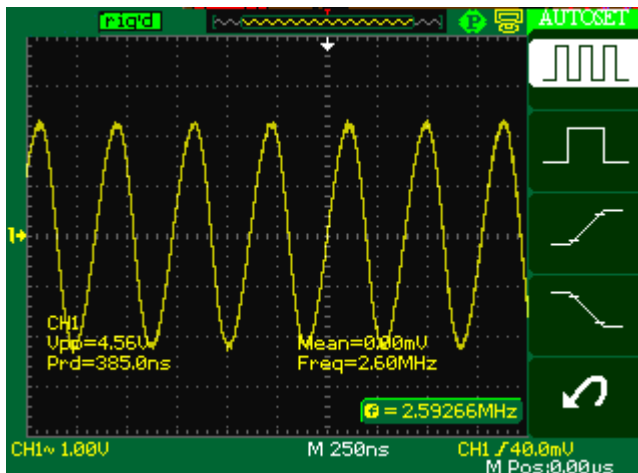

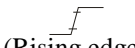
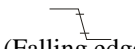



Figure 12 - Auto Setup

Table 1 - Autoset Menu

Option	Description
 (Multi-cycle sine)	Auto set the screen and display several cycles signal.
 (Single-cycle sine)	Set the screen and auto display single cycle signal.
 (Rising edge)	Auto set and show the rising time.
 (Falling edge)	Auto set and show the falling time.
 (Undo Setup)	Causes the oscilloscope to recall the previous setup.

Auto set determines the trigger source based on the following conditions:

- If multiple channels have signals, channel with the lowest frequency signal.
- No signals found, the lowest-numbered channel displayed when Auto set was invoked
- No signals found and no channels displayed, oscilloscope displays and uses channel 1.

Table 2 - Autoset Function Menu Items

Function	Setting
Acquire Mode	Adjusted to Sampling
Display Format	Y-T
Display Type	Set to Dots for a video signal, set to Vectors for an FFT spectrum; otherwise, unchanged
Vertical Coupling	Adjusted to DC or AC according to the input signal
V/div	Adjusted
VOLTS/DIV adjustability	Coarse
Signal inverted	Off
Horizontal position	Center
TIME/DIV	Adjusted
Trigger type	Edge
Trigger source	Auto detect the channel which has the input signal
Trigger slope	Rising
Trigger mode	Auto
Trigger coupling	DC
Trigger holdoff	Minimum
Trigger level	Set to 50%

Note: The AUTO button can be disabled. Please see “Appendix C Disabling Auto Function” for details.

Default Setup

The oscilloscope is set up for normal operation when it is shipped from the factory. This is the default setup. To recall this setup, press the **DEFAULT SETUP** button. For the default options, buttons and controls when you press the **DEFAULT SETUP** button, refer to “Appendix A Default Setup”.

The **DEFAULT SETUP** button does not reset the following settings:

- Language option
- Saved reference waveform files
- Saved setup files
- Display contrast
- Calibration data

Universal Knob



Figure 13 - Universal Knob

You can use the Universal knob with many functions, such as adjusting the hold off time, moving cursors, setting the pulse width, setting the video line, adjusting the upper and lower frequency limit, adjust X and Y masks when using the pass/fail function, etc. You can also turn the “Universal” knob to adjust the storage position of setups, waveforms, pictures when saving/recalling, and to select menu options. With some functions, the light indicator above the knob will turn on to indicate that the knob can be used to make changes or adjustments for that function. The knob can also be pushed to make a selection after changes/adjustments have been made.

Vertical System

The vertical control could be used for displaying waveform, rectify scale and position.



Figure 14 - Vertical System Controls

Channel Function Menu

Table 3- Channel Function Menu

Option	Setting	Introduction
Coupling	DC	DC passes both AC and DC components of the input signal.
	AC	AC blocks the DC component of the input signal and attenuates signals below 10 Hz.
	GND	GND disconnects the input signal.
Volts/Div	Coarse	Selects the resolution of the Volts/Div knob
	Fine	Coarse defines a 1-2-5 sequence. Fine changes the resolution to small steps between the coarse settings.
Probe	1X	Set to match the type of probe you are using to ensure correct vertical readouts.
	5X	
	10X	
	50X	
	100X	
	500X	
	1000X	
Next Page	Page 1/2	Press this button to enter second page menu.

Option	Setting	Instruction
Invert	on	Turn on invert function.
	off	Turn off invert function.
Filter		Press this button to enter the “Digital Filter menu”.(See Error! Reference source not found.)
Next Page	Page 2/2	Press this button to return the first page menu.

Table 4 - Channel Function Menu 2





Option	Setting	Introduction
Filter	On	Turn on the digital filter.
	Off	Turn off the digital filter.
Type		Setup as LPF (Low Pass Filter).
		Setup as HPF (High Pass Filter).
		Setup as BPF (Band Pass Filter).
		Setup as BRF (Band Reject Filter).
Upper_limit		Turn the “Universal” knob to set upper limit.
Lower_limit		Turn the “Universal” knob to set lower limit.
Return		Return to digital filter main menu.

Table 5 - Digital Filter Function Menu

- **“GND” Coupling:** Use GND coupling to display a zero-volt waveform. Internally, the channel input is connected to a zero-volt reference level.
- **Fine Resolution:** The vertical scale readout displays the actual Volts/Div setting while in the fine resolution setting. Changing the setting to coarse does not change the vertical scale until the VOLTS/DIV control is adjusted.

Note:

- The oscilloscope vertical response rolls off slowly above its bandwidth, which is 25 MHz. Therefore, the FFT spectrum can show valid frequency information higher than the oscilloscope bandwidth. However, the magnitude information near or above the bandwidth will not be accurate.
- If the channel is set to DC coupling, you can quickly measure the DC component of the signal by simply noting its distance from the ground symbol.
- If the channel is set to AC coupling, the DC component of the signal is blocked allowing you to use greater sensitivity to display the AC component of the signal.

Setting Up Channels

Each channel has its own separate Menu. The items are set up separately according to each channel.

1. Setup Channel Coupling

Take the CH1 for example; the tested signal is a sine wave signal with DC deflection:

- Press“CH1”→“Coupling”→“AC”, Set to AC couple mode.

This will block the DC component of the input signal.

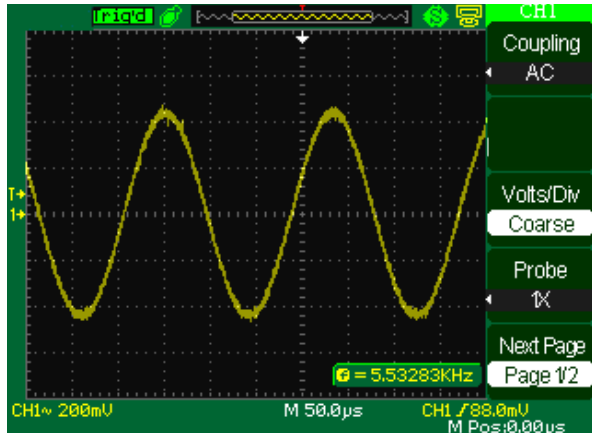

Figure 15 - AC Coupling

- Press“CH1”→“Coupling”→“DC”, Set to DC couple mode.

Both DC and AC components of the input signal will be captured.

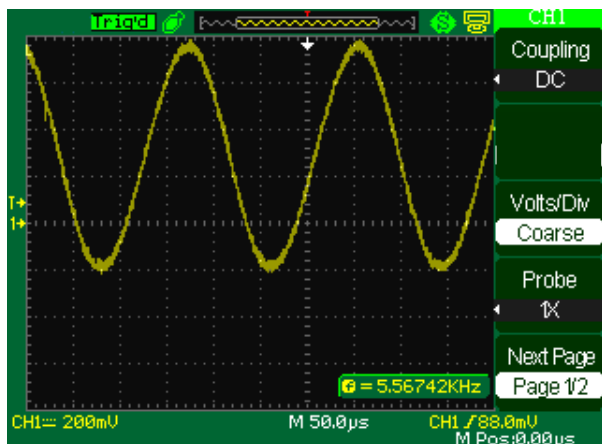

Figure 16 - DC Coupling

- Press “CH1”→“Coupling”→“GND”, Set to GROUND mode.

This disconnects the input signal.

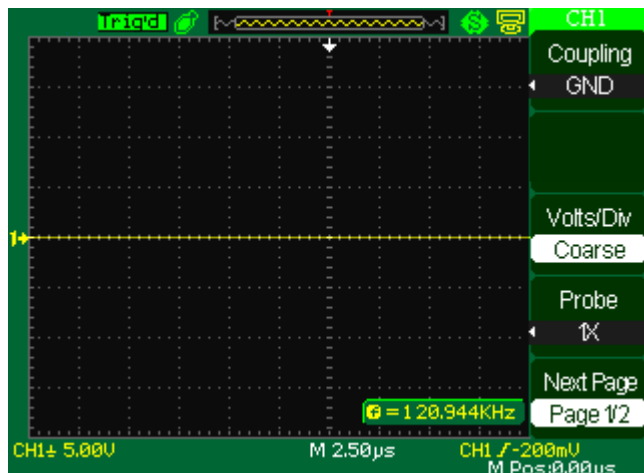

Figure 17 - GND Coupling

2. Volts/Div Settings

Vertical scale adjust have Coarse and Fine modes, Vertical sensitivity range of 2 mV/div – 10 V/div.

Take CH1 for example:

- Press “CH1” → “Volts/Div” → “Coarse”. It is the default setting of Volts/Div, and it makes the vertical scaling in a 1-2-5-step sequence from 2 mV/div, 5 mV/div, 10 mV/div to 10 V/div.

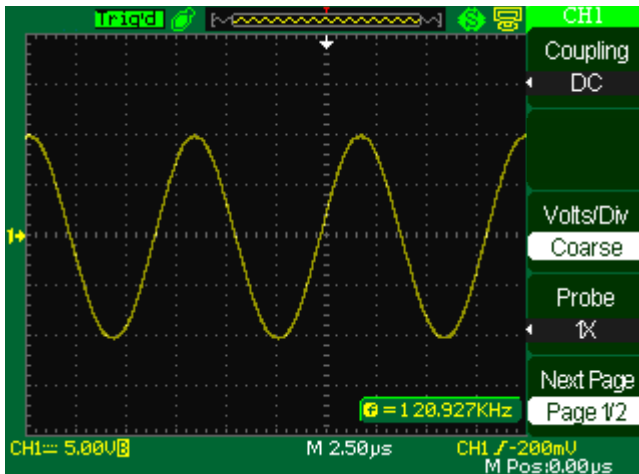

Figure 18 - Coarse Control

- Press “CH1” → “Volts/Div” → “Fine”. This setting changes the vertical control to small steps between the coarse settings. It will be helpful when you need to adjust the waveform vertical size in smaller steps.

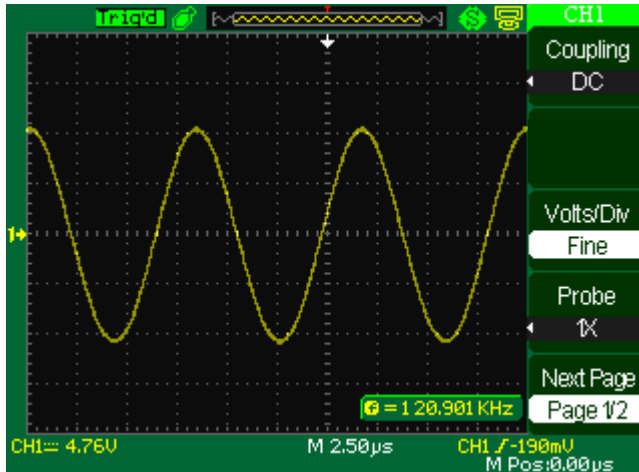

Figure 19 - Fine Control

3. Setting Probe Attenuation

In order to assort the attenuation coefficient, you need to respond in the channel operation Menu. If the attenuation coefficient is 10:1, the input coefficient should be set to 10X, so that the Volts/div information and measurement testing is correct.

Take CH1 for example, when you use the 100:1 probe:

- Press “CH1” → “Probe” → “100X

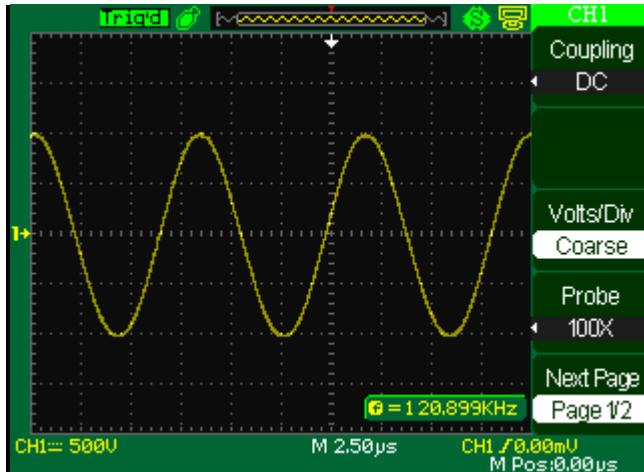

Figure 20 - Setting Probe Attenuation

4. Inverting waveforms

Take CH1 for example:

- Press “CH1” → Next Page “ page 1/2” → “Invert” → “On”:

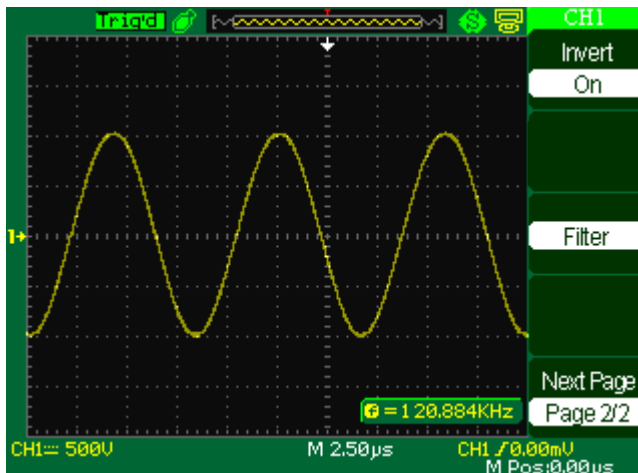

Figure 21- Invert Waveform Screen

5. Using the Digital Filter

Press “CH1”→“Next Page page1/2”→ “Filter”, display the digital filter menu. Select “Filter Type”, then select “Upper Limit” or “Lower Limit” and turn the “Universal” knob to adjust them.

- Press “CH1”→“Next Page page1/2”→ “Filter” →“Off”. Turn off the Digital Filter function.

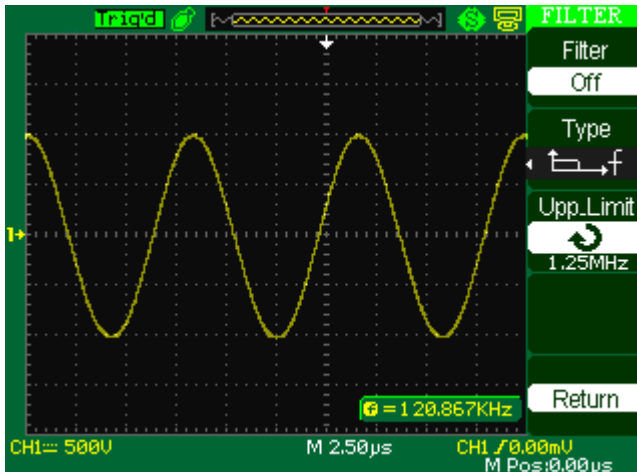

Figure 22 - Digital Filter Menu

- Press “CH1”→ “Next Page page1/2”→ “Filter” → “On”. Turn on the Digital Filter function.

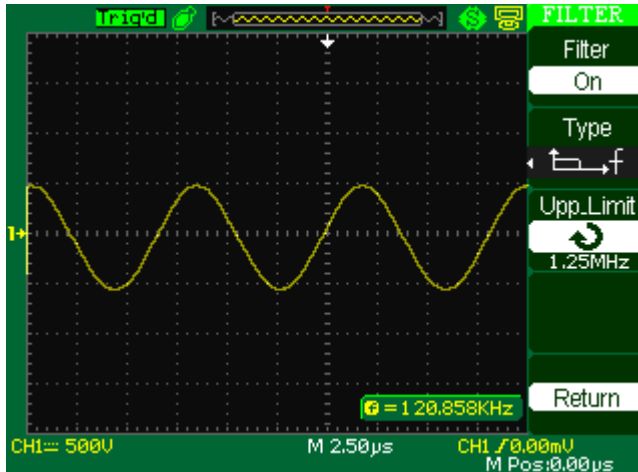

Figure 23 - Digital Filter Adjustment Screen

Using Vertical Position Knob and Volt/div Knob

- **Vertical “POSITION” knob**
 1. Use the Vertical “POSITION” knobs to move the channel waveforms up or down on the screen. This button’s resolution varies based on the vertical scale.
 2. When you adjust the vertical position of channel waveforms, the vertical position information will display on the bottom left of the screen. For example “Volts Pos=24.6mV”.
 3. Press the vertical “POSITION” knob to set the vertical position to zero.

- **“Volts/div” knob**

1. Use the “Volts/div” knobs to control how the oscilloscope amplifies or attenuates the source signal of channel waveforms. When you turn the “volts/div” knob, the oscilloscope increases or decreases the vertical size of the waveform on the screen with respect to the ground level;
2. When you press the “Volt/div” Knob, you can switch “Volt/div” option between “Coarse” and “Fine”. The vertical scale is set by the 1-2-5 step in the Coarse. Increase in the clockwise direction, decrease in the counter clockwise direction. In the fine mode, the knob changes the Volts/Div scale in small steps between the coarse settings. Again, increase in the clockwise direction, decrease in the counterclockwise direction.

Math Functions

Math shows the results after +, -, *, /, and FFT operation of CH1 and CH2.

Press the MATH button to display the waveform math operations. Press the

MATH button again to remove the math waveform display.

Table 6 - Math Function Menu

Function	Setting	Introduction
Operation	+, -, *, /, FFT	Math operations between signal source CH1 and CH2.
CH1 Invert	on off	Invert the CH1 waveform. Turn off CH1 Invert function.
CH2 Invert	on off	Invert the CH2 waveform. Turn off CH2 Invert function.

Table 7 - Math Function Description

Operation	Setting	Introduction
+	CH1+CH2	CH1 waveform adds CH2 waveform.
-	CH1-CH2	The channel 2 waveform is subtracted from the channel 1 waveform.
	CH2-CH1	The channel 1 waveform is subtracted from the channel 2 waveform.
*	CH1*CH2	Source 1 multiply source 2.
/	CH1/CH2	The channel 2 waveform is divided by the channel 1 waveform.
	CH2/CH1	The channel 1 waveform is divided by the channel 2 waveform.
FFT	Fast Fourier Transform.	

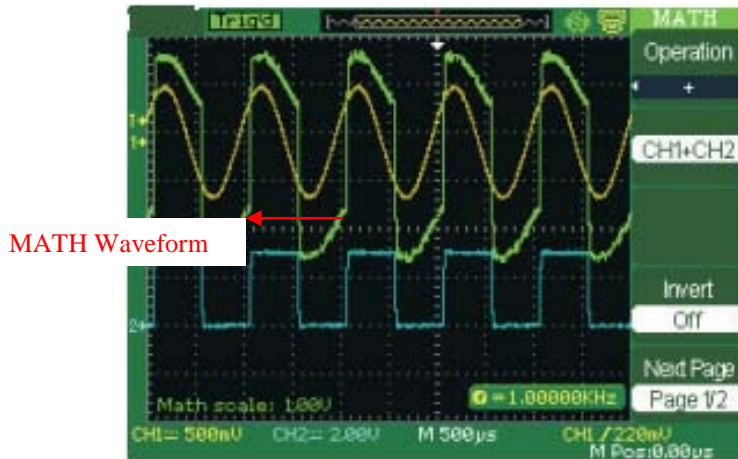

Figure 24- CH1 added with CH2

FFT Spectrum Analyzer

The FFT process mathematically converts a time-domain signal into its frequency components. You can use the Math FFT mode to view the following types of signals:

- Analyze the harmonic wave in a power cable.
- Test the harmonic content and distortion in a system
- Show the Noise in a DC power supply
- Test the filter and pulse response in a system
- Analyze vibration

Table 8 - FFT Function Menu 1

FFT Option	Setting	Introduction
Source	CH1, CH2	Select this channel as the FFT source.
Window	Hanning Hamming Rectangular Blackman	Select FFT window types.
FFT ZOOM	1X 2X 5X 10X	Changes the horizontal magnification of the FFT display.
Next Page	Page 1/2	Enter the second page of FFT menu.

Table 9 - FFT Function Menu 2

FFT Option	Setting	Introduction
Scale	Vrms	Set Vrms to be the Vertical Scale unit.
	dBVrms	Set dBVrms to be the vertical Scale unit.
Display	Split Full screen	Display FFT waveform on half screen. Display FFT waveform on full screen.
Next Page	Page 2/2	Return the first page of FFT menu.

To use the Math FFT mode, you need to perform the following tasks:

1. Set up the source (time-domain) waveform.
2. Press the AUTO button to display a YT waveform.
3. Turn the vertical "POSITION" knob to move the YT waveform to the center vertically (zero divisions).

4. Turn the horizontal “POSITION” knob to position the part of the YT waveform that you want to analyze in the center eight divisions of the screen.
5. The oscilloscope calculates the FFT spectrum using the center 1024 points of the time-domain waveform.
6. Turn the “Volts/div” knob to ensure that the entire waveform remains on the screen.
7. Turn the “time/div” knob to provide the resolution you want in the FFT spectrum.
8. If possible, set the oscilloscope to display many signal cycles.

To display FFT correctly, follow these steps:

1. Push the “MATH” button.
2. Set the “Operation” option to FFT.
3. Press the “Source” button to select “CH1” or “CH2” according to input signal channel.
4. According to Nyquist law, turn the “time/div” knob to adjust the sampling rate (this parameter is displayed behind the time base parameter), making sure it is at least double the input signal frequency.

Displaying the FFT Spectrum

Press the MATH button to display the Math Menu. Use the options to select the Source channel, Window algorithm, and FFT Zoom factor. You can display only one FFT spectrum at a time. You can select “Full screen” or “Split” in “Display” option to display FFT waveform on full screen or display channel waveform and its FFT waveform on half screen at a time.

Figure 25 - Math Function Screen

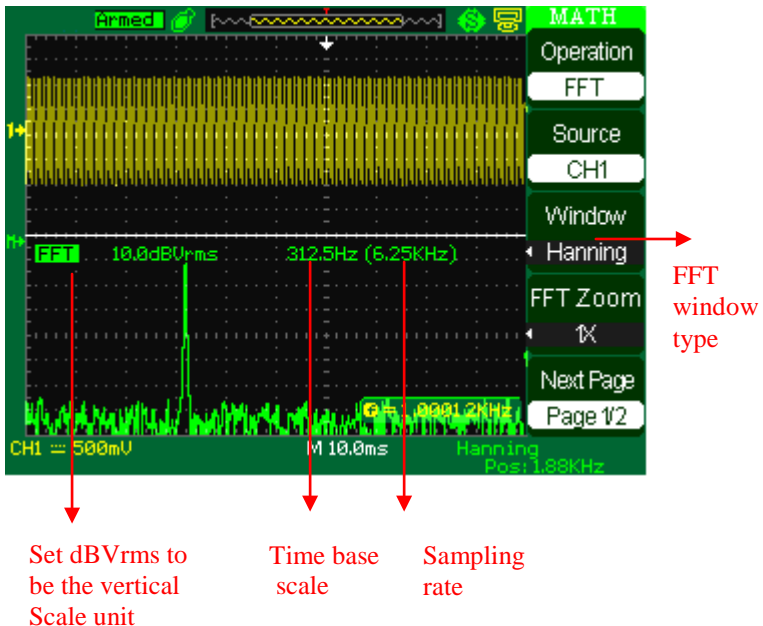

Select FFT Window

Windows reduce spectral leakage in the FFT spectrum. The FFT assumes that the YT waveform repeats forever. With an integral number of cycles, there are no discontinuities in the signal shape. A non-integral number of cycles in the YT waveform cause the signal start and end points to be at different amplitudes. The transitions between the start and end points cause discontinuities in the signal that introduce high-frequency transients.

Table 10 - FFT Window Instruction

Window	Characteristics	Applications
Rectangular	Best frequency resolution, worst magnitude resolution. This is essentially the same as no window.	Symmetric transients or bursts. Equal-amplitude sine waves with fixed frequencies. Broadband random noise with a relatively slowly varying spectrum.
Hanning Hamming	Better frequency, poorer magnitude accuracy than Rectangular. Hamming has slightly better frequency resolution than Hanning.	Sine, periodic, and narrow-band random noise. Asymmetric transients or bursts.
Blackman	Best magnitude, worst	Single frequency

	frequency resolution.	waveforms, to find higher order harmonics.
--	-----------------------	--

Magnifying and Positioning and FFT Spectrum

You can magnify and use cursors to take measurements on the FFT spectrum. The oscilloscope includes an “FFT Zoom” option to magnify horizontally, press this option button to select “1X”, “2X”, “5X” or “10X”. Moreover, you also can turn the “Universal” knob to magnify FFT waveform horizontally in a 1-2-5 step. To magnify vertically; you can turn the “Volts/div” knob.

Measuring an FFT Spectrum Using Cursors

You can take two measurements on FFT spectrums: magnitude (in dB) and frequency (in Hz). Magnitude is referenced to 0 dB, where 0 dB equals 1 VRMS. You can use the cursors to take measurements at any zoom factor. Use horizontal cursors to measure amplitude and vertical cursors to measure frequency.

If you input a sine signal to channel 1, follow these steps:

- 1. Measure FFT Amplitude**

1. Input a sine signal to channel 1, and press the “AUTO” button.
2. Press the “MATH” button to enter the “MATH” menu.
3. Press the “Operation” option button to select “FFT”.
4. Press the “Source” option button to select “CH1”.
5. Press CH1 button to display CH1 menu.
6. Turn the “time/div” knob to adjust sampling rate (at least double bigger than frequency of input signal).
7. If FFT display on full screen, press CH1 button again to remove channel waveform display.
8. Press the “CURSOR” button to enter “Cursor” menu.
9. Press the “Cursor Mode” button to select “Manual”.
10. Press the “Type” option button to select “Voltage”.
11. Press the “Source” option button to select “FFT”.
12. Press the “CurA” option button; turn the “Universal” knob to move Cursor A to the highest point of the FFT waveform.
13. Press the “CurB” option button, turn the “Universal” knob to move Cursor B to the lowest point of the FFT waveform.
14. The amplitude (ΔT) displays on the top of the left screen.

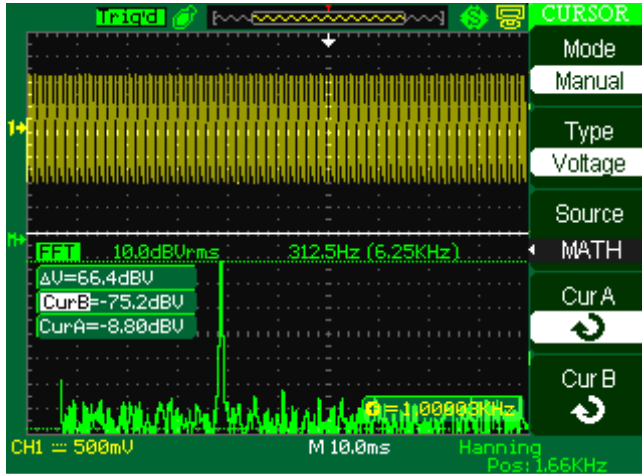

Figure 26 - Measure FFT Screen

2. Measure FFT Frequency

1. Press the CURSOR button.
2. Press the “Cursor Mode” button to select “Manual”.
3. Press the “Type” option button to select “Time”.
4. Press the “Source” option button to select “FFT”.
5. Press the “CurA” option button, turn the “Universal” button to move Cursor A to the highest position of the FFT waveform.
6. The value of CurA displaying on the top of the left screen is FFT highest Frequency. This frequency should be the same as input signal frequency.

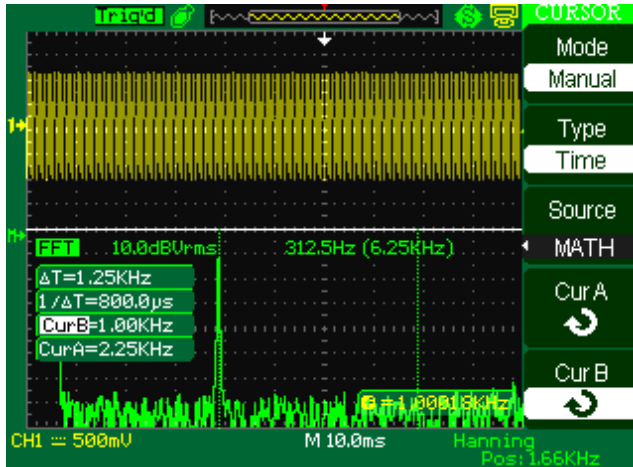

Figure 27 - Measure FFT Frequency Screen

NOTE: - The FFT of a waveform that has a DC component or offset can cause incorrect FFT waveform magnitude values. To minimize the DC component, choose AC Coupling on the source waveform.

- To display FFT waveforms with a large dynamic range, use the dBVrms scale. The dBVrms scale displays component magnitudes using a log scale.
- The Nyquist frequency is the highest frequency that any real-time digitizing oscilloscope can acquire without aliasing. This frequency is half that of the sample rate provided it is within the analog bandwidth of the oscilloscope. Frequencies above the Nyquist frequency will be under sampled, which causes aliasing.

Using REF

The reference control saves waveforms to a nonvolatile waveform memory.

The reference function becomes available after a waveform has been saved.

Table 11 - REF Function Menu

Option	Setting	Introduction
Source	CH1,CH2, CH1 off CH2 off	Choose the waveform display to store.
REFA REFB		Choose the reference location to store or recall a waveform.
Save		Stores source waveform to the chosen reference location.
REFA/REFB	on off	Recall the reference waveform on the screen. Turn off the reference waveform.

Press the Ref button to display the “Reference waveform menu”.

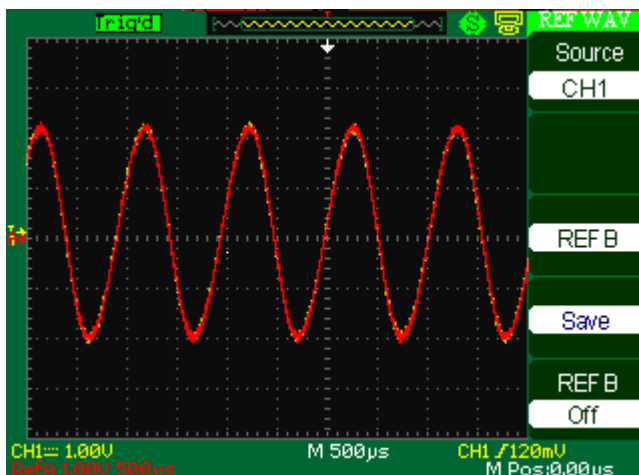

Figure 28 - Reference Waveform Menu

Operation step:

1. Press the “REF” menu button to display the “Reference waveform menu”.
2. Press the “Source” option button to select input signal channel.
3. Turn the vertical “POSITION” knob and “Volt/div” knob to adjust the vertical position and scale.
4. Press the third option button to select “REFA” or “REFB” as storage position.
5. Press the “Save” option button.
6. Press the bottom option button to select “REFA On” or “REFB On” to recall the reference waveform.

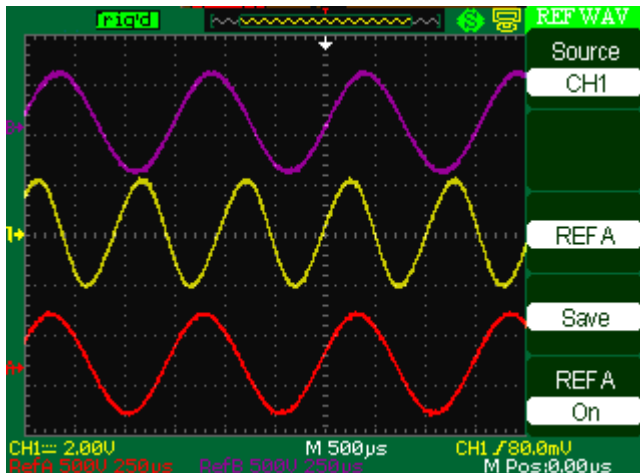

Figure 29 - REF Waveform Menu

- Note:** - X-Y mode waveforms are not stored as reference waveforms.
- You cannot adjust the horizontal position and scale of the reference waveform.

Horizontal System

Shown below, there is one button and two knobs in the HORIZONTAL area.

Table 12 - Horizontal System Function Menu

Option	Setting	Description
Delayed	On	Turn on this function for main timebase waveform to display on the top half screen and window timebase waveform to display on the below half screen at the same time.
	Off	Turn off this function to only display main timebase waveform on the screen.

Horizontal Control Knob

You can use the horizontal controls to change the horizontal scale and position of waveforms. The horizontal position readout shows the time represented by the center of the screen, using the time of the trigger as zero.

Changing the horizontal scale causes the waveform to expand or contract around the screen center.

- **Horizontal “POSITION” knob**

1. Adjust the horizontal position of all channels and math waveforms (the position of the trigger relative to the center of the screen). The resolution of this control varies with the time base setting.
2. When you press the horizontal “POSITION” Knob, you can set the horizontal position to zero.

- **“time/div” knob**

1. Used to change the horizontal time scale to magnify or compress the waveform. If waveform acquisition is stopped (using the RUN/STOP or SINGLE button), turn the time/div knob to expand or compress the waveform.
2. Select the horizontal time/div (scale factor) for the main or the window time base. When Window Zone is enabled, it changes the width of the window zone by changing the window time base.

- **Display scan mode:**

When the TIME/DIV control is set to 100 ms/div or slower and the trigger mode is set to Auto, the oscilloscope enters the scan acquisition mode. In this mode, the waveform display updates from left to right. There is no trigger or horizontal position control of waveforms during scan mode.

Window Zone

Use the Window Zone option to define a segment of a waveform to see more detail. This function behaves like zooming into a portion of the captured waveform. The window time base setting cannot be set slower than the Main time base setting.

You can turn the Horizontal Position and TIME/DIV controls to enlarge or minimize waveforms in the Window Zone.

If you want to see a section of the waveform in details, follow these steps:

1. Press the “HORI MENU” button to enter the “Horizontal menu”.
2. Turn the “time/div” knob to change the main timebase scale.
3. Press the “Delayed” option button to select “On”.

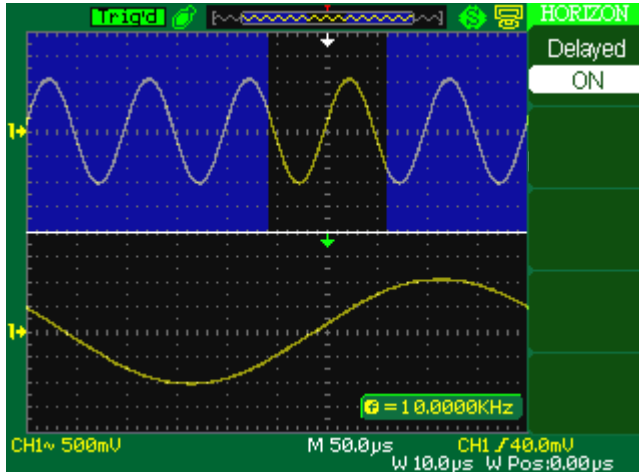

Figure 30 - Horizontal Delay Menu

4. Turn the “Horizontal Position” knob (adjust window’s position) to select the window that you need and expanded window waveform display will show on the below half of the screen at the same time.

Trigger System

The trigger determines when the oscilloscope starts to acquire data and display a waveform. When a trigger is set up properly, the oscilloscope converts unstable displays or blank screens into meaningful waveforms.

Here are three buttons and one knob in the trigger area. See below:

- **“TRIG MENU” Button:** Press the “TRIG MENU” Button to display the “Trigger Menu”.
- **“LEVEL” Knob:** The LEVEL knob is to set the corresponding signal voltage of trigger point in order to sample. Press the “LEVEL” knob to set trigger level to zero.
- **“SET TO 50%” Button:** Use the “SET TO 50%” button to stabilize a waveform quickly. The oscilloscope can set the Trigger Level to be about halfway between the minimum and maximum voltage levels automatically. This is useful when you connect a signal to the EXT TRIG BNC and set the trigger source to Ext or Ext/5.
- **“FORCE Button:** Use the FORCE button to complete the current waveform acquisition whether the oscilloscope detects a trigger or not. This is useful for SINGLE acquisitions and Normal trigger mode.
- **Pre-trigger/Delayed trigger:** The data before and after trigger at the trigger position is typically set at the horizontal center of the screen, in the full-screen display the 6div data of pre-trigger and delayed trigger can be surveyed. More data of pre-trigger and 1s delayed trigger can be surveyed by adjusting the horizontal position.

The feature is very useful because you can see the events that led up to the trigger point. Everything to the right of the trigger point is the post-trigger information. The amount of delay range (pre-trigger and post-trigger information) available is dependent on the sweep speed selected.

Signal Source

You can use the Trigger Source options to select the signal that the oscilloscope uses as a trigger. The source can be any signal connected to a channel BNC, to the EXT TRIG BUS, or the AC power line (available only with Edge Trigger).

Trigger Type

The scopes have five trigger types: Edge, Video, Pulse, Slope, and Alternative.

Edge Trigger

Use Edge triggering to trigger on the edge of the oscilloscope input signal at the trigger threshold.

Table 13 - Edge Trigger Function Menu

Option	Setting	Explain
Type	Edge	With Edge highlighted, the rising or falling edge of the input signal is used for the trigger.
Source	CH1 CH2	Triggers on a channel whether or not the waveform is displayed.
	EXT	Does not display the trigger signal; the Ext option uses the signal connected to the EXT TRIG front-panel BNC and allows a trigger level range of -1.2 V to +1.2 V.
	EXT/5	Same as Ext option, but attenuates the signal by a factor of five, and allows a trigger level range of +6 V to -6 V. This extends the trigger level range.
	AC Line	This selection uses a signal derived from the power line as the trigger source; trigger coupling is set to DC and the trigger level to 0 volts.
Slope		<p>Trigger on Rising edge of the trigger signal.</p> <p>Trigger on Falling edge of the trigger signal.</p> <p>Trigger on Rising edge and Falling edge of the trigger signal.</p>
Mode	Auto	Use this mode to let the acquisition free-run in the absence of a valid trigger. This mode scans waveform at 100 ms/div or slower time base settings.
	Normal	Use this mode when you want to see only valid triggered waveforms; when you use this mode, the oscilloscope does not display a waveform until after the first trigger.
	Single	When you want the oscilloscope to acquire a single capture of a waveform, press the “SINGLE” button.
Set up		Enter the “Trigger Setup Menu” (See below table).

Table 14 - Trigger Setup Function Menu

Option	Setting	Explain
Coupling	DC	Passes all components of the signal
	AC	Blocks DC components, attenuates signals below 50 Hz.
	HF Reject	Attenuates the high-frequency components above 150 kHz.
	LF Reject	Blocks the DC component attenuates the low-frequency components below 7 kHz.
Holdoff ↻		Using the “universal” knob to adjust holdoff time (sec), the holdoff value is displayed.
Holdoff Reset		Reset holdoff time to 100 ns.
Return		Return the first page of “Trigger main menu”.

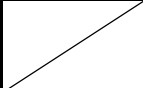
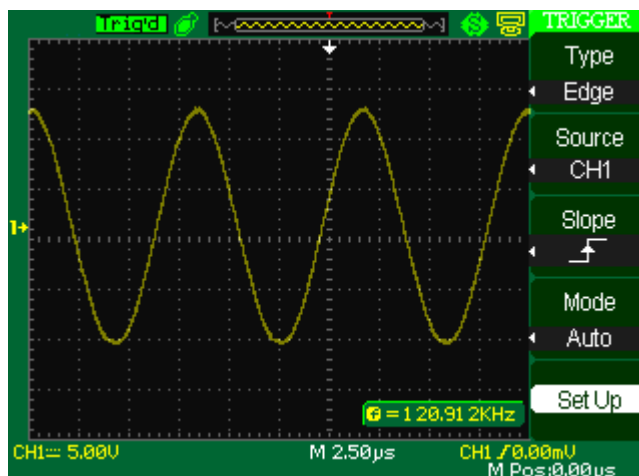

Figure 31 - Trigger Menu Screen

Operating Instructions:



1. Set up Type

- 1) Press the “TRIG MENU” button to display “Trigger” menu.
- 2) Press the “Type” option button to select “Edge”.

2. Set up Source

According to input signal, press the “Source” option button to select “CH1”, “CH2”, “EXT”, “EXT/5” or “AC Line”.

3. Set up Slope

Press the “Slope” option button to select “”, “” or “”.

4. Set up Trigger mode

Press the “Trigger mode” option button to select “Auto”, “Normal”, “Single”.

Auto: The waveform refresh at a high speed whether the trigger condition is satisfied or not.

Normal: The waveform refresh when the trigger condition is satisfied and waits for next trigger event occurring when the trigger condition is not satisfied.

Single: The oscilloscope acquire a waveform when the trigger condition is satisfied and then stops.

5. Set up Trigger coupling







- Press the “Set up” button to enter the “Trigger Setup Menu”.
- Press the “Coupling” option button to select “DC”, “AC”, “HF Reject” or “LF Reject”.

Pulse Trigger

Use Pulse Width triggering to trigger on aberrant pulses.

Table 15 - Pulse trigger Function Menu 1

Option	Setting	Explain
Type	Pulse	Select the pulse to trigger the pulse match the trigger condition.
Source	CH1 CH2 EXT EXT/5	Select input signal source.

When	 (Positive pulse width less than pulse width setting)  (Positive pulse width larger than pulse width setting)  (Positive pulse width equal to pulse width setting)  (Negative pulse width less than pulse width setting)  (Negative pulse width larger than pulse width setting)  (Negative pulse width equal to pulse width setting)	Select how to compare the trigger pulse relative to the value selected in the Set Pulse Width option.
Set Width	20.0 ns~10.0 s	Selecting this option can turn the universal to set up the pulse width.
Next Page	Page 1/2	Press this button to enter the second page.

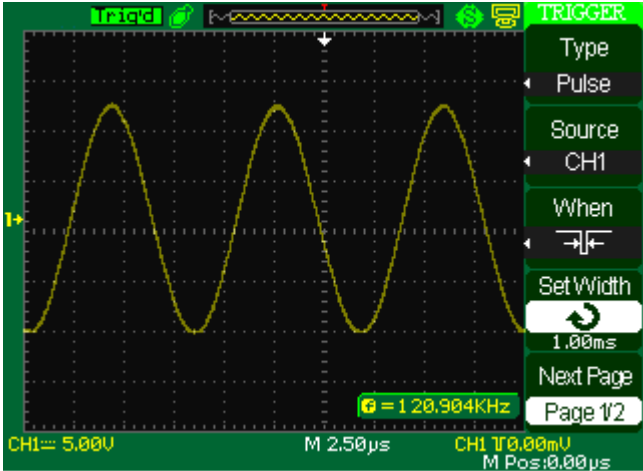

Figure 32 - Pulse Trigger Menu Screen

Table 16 - Pulse Trigger Function Menu 2

Option	Setting	Explain
Type	Pulse	Select the pulse to trigger the pulse match the trigger condition.
Mode	Auto Normal single	Select the type of triggering; Normal mode is best for most Pulse Width trigger applications.
Set up		Enter the “Trigger setup menu”.
Next Page	Page 2/2	Press this button to return the first page.

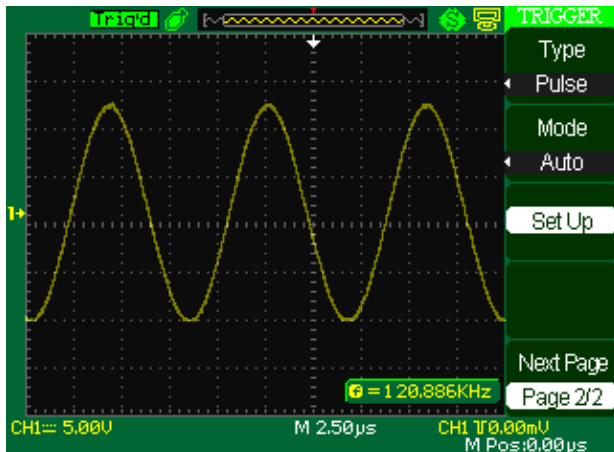







Figure 33 - Pulse Trigger Menu 2

Operating Instructions:

1. Set up Type

- 1) Press the “TRIG MENU” button to display “Trigger menu”.
- 2) Press the “Type” option button to select “Pulse”.

2. Set up condition

Press the “When” option button to select “”, “”, “”, “”, “” or “”.



3. Set up pulse width

Turn the “Universal” knob to set up width.

Video Trigger

Trigger on fields or lines of standard video signals.

Table 17 - Functional Menu of Video Trigger 1

Option	Setting	Instruction
Type	Video	When you select the video type, put the couple set to the AC, then you could trigger the NTSC, PAL and SECAM video signal.
Source	CH1 CH2	Select the input source to be the trigger signal.
	EXT EXT/5	Ext and Ext/5 use the signal applied to the EXT TRIG connector as the source.
Polarity	 (Normal)	Normal triggers on the negative edge of the sync pulse.
	 (Inverted)	Inverted triggers on the positive edge of the sync pulse.
Sync	All lines Line Num Odd field Even Field	Select appropriate video sync.
Next Page	Page 1/2	Enter the second page of “Video trigger menu”.

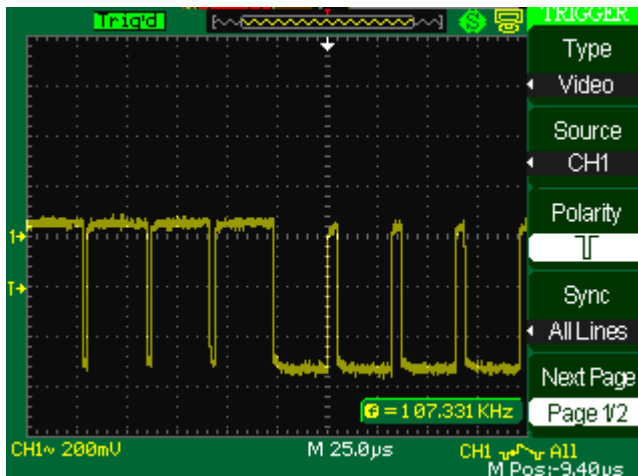
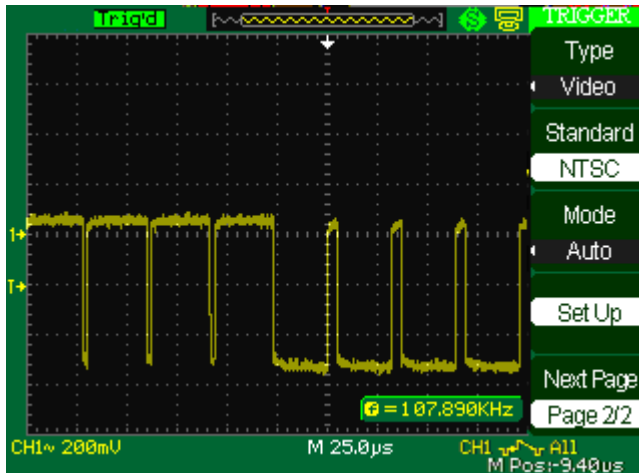

Figure 34 - Video Trigger Screen

Table 18 - Functional Menu of Video Trigger 2

Option	Setting	Instruction
Type	Video	When you select the video type, put the couple set to the AC, then you could trigger the NTSC,PAL and SECAM video signal.
Standard	NTSC Pal/Secam	Select the video standard for sync and line number count.
Mode	Auto	Use this mode to let the acquisition free-run in the absence of a valid trigger.
	Normal	Use this mode when you want to see only valid triggered waveforms; when you use this mode, the oscilloscope does not display a waveform until after the first trigger.
	Single	When you want the oscilloscope to acquire a single waveform,

		press the “SINGLE ”button.
Set up		Enter the “Trigger setup menu”.
Next Page	Page 2/2	Return the first page of “Video Trigger menu”.





Operating Instructions:

Set up Type

1. Press the “TRIG MENU” button to display “Trigger” menu.
2. Press the “Type” option button to select “Video”.

Set up Polarity

1. Press the “Polarity” option button to select “ ” or “ ”.

Set up Synchronization

1. Press the “Sync” option button to select “All Lines”, “Line Num”, “Odd Field”, and “Even Field”.
2. If you select “Line Num”, you can turn the “Universal” knob to set the appointed line number.

Set up Standard



1. Press the “next Page Page2/2” option button.
2. Press the “Standard” option button to select “PAL/SECAM” or “NTSC”.

Slope Trigger

Trigger on positive slope or negative slope according to setup time of the oscilloscope.

Table 19 - Slope Trigger Function Menu 1

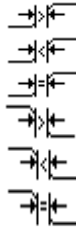
Option	Setting	Instruction
Type	Slope	Trigger on positive slope of negative slope according to setup time of the oscilloscope.
Source	CH1 CH2 EXT EXT/5	Select trigger source.

When		Select trigger condition.
Time	 < Set Time >	Turn the “Universal” knob to set slope time. Time setup range is 20ns-10s.
Next Page	Page 1/2	Enter the second page of slope trigger.

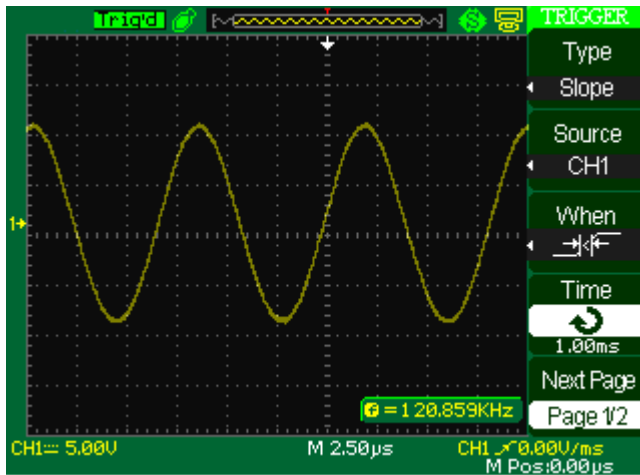



Figure 35 - Slope Trigger Menu

Table 20 - Slope Trigger Function Menu 2

Option	Setting	Instruction
Type	Slope	Trigger on positive slope of negative slope according to setup time of the oscilloscope.
Vertical		Select the trigger level that can be adjusted by “LEVEL” knob. You can adjust “LEVEL A”, “LEVEL B” or adjust them at the same time.
Mode	Auto	Use this mode to let the acquisition free-run in the absence of a valid trigger; This mode allows an untriggered, scanning waveform at 100 ms/div or slower time base settings.
	Normal	Use this mode when you want to see only valid triggered waveforms; when you use this mode, the oscilloscope does not display a waveform until after the first trigger.
	Single	When you want the oscilloscope to acquire a single waveform, press the “SINGLE” button.
Set up	/	Enter the “Trigger setup menu” (See table 2-14).
Next Page	Page 2/2	Return the first page of slope trigger.

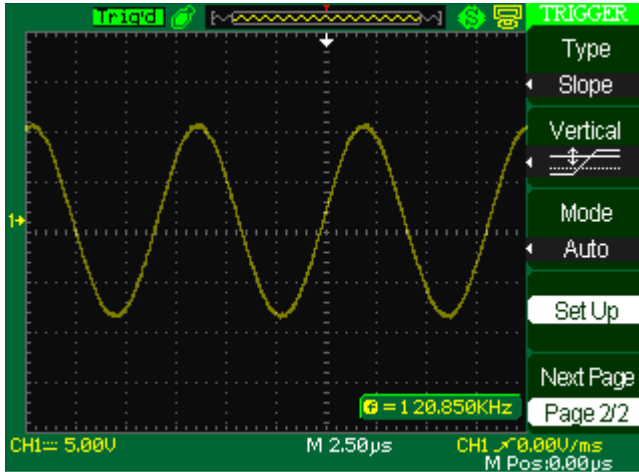







Figure 36 - Slope Trigger Menu 2

Operating Instructions:

Follow next steps if you select “Slope trigger”:

1. Input a signal to CH1 or CH2.
2. Press the “AUTO” button.
3. Press the “TRIG MENU” button to enter “Trigger menu”.
4. Press the “Type” option button to select “Slope”.
5. Press the “Source” option button to select “CH1” or “CH2”.
6. Press the “When” option button to select “  ”, “  ”, “  ”, “  ” or “  ”.

7. Press the “Time” button and turn the “Universal” knob to adjust slope time.
8. Press the “Next Page - Page 1/2” option button to enter the second page of the “Slope trigger menu”.
9. Press the “Vertical” option button to select a trigger level that can be adjusted.
10. Turn the “LEVEL” knob.

Alternative Trigger

The trigger signal comes from two vertical channels when you use alternative trigger. In this mode, you can observe two irrelative signals at the same time. You can select different trigger types for two vertical signals. Different types include edge, pulse, video, and slope trigger. Trigger information for both channels will display on the bottom right of the screen.

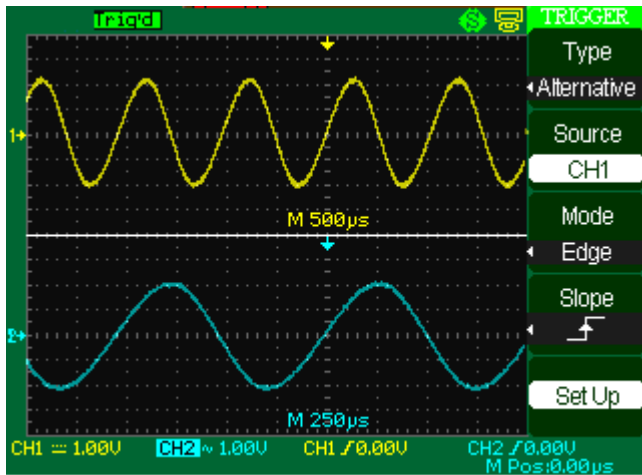

Figure 37 - Alternate Trigger Menu

Table 21 - Set Trigger Mode to Edge Trigger Function Menu 1

Option	Setting	Instruction
Type	Alternative	The trigger signal comes from two vertical channels when you use alternative trigger. In this mode, you can observe two irrelative signals at the same time.
Source	CH1 CH2	Set trigger type information for CH1 signal. Set trigger type information for CH2 signal.
Mode	Edge	Set trigger type of the vertical channel signal to Edge.
Slope		Triggering on rising edge. Triggering on falling edge. Triggering on rising edge and falling edge.
Set Up		Enter the "Trigger setup menu" (See table 2-14).

Table 22 - Set Trigger Mode to Pulse Trigger Function Menu 1

Option	Setting	Instruction
Type	Alternative	The trigger signal comes from two vertical channels when you use alternative trigger. In this mode, you can observe two irrelative signals at the same time.
Source	CH1 CH2	Set trigger type information for CH1 signal. Set trigger type information for CH2 signal.
Mode	Pulse	Set trigger type of the vertical channel signal to Pulse trigger.

When		Select how to compare the trigger pulse relative to the value selected in the Set Pulse Width option.
Next Page	Page 1/2	Enter the second page of Alternative trigger menu.

Table 23 - Set Trigger Mode to Pulse Trigger Function Menu 2

Option	Setting	Explain
Set Width	20.0 ns~10.0 s	Selecting this option can turn the universal to set up the pulse width.
Set up		Enter the “Trigger Setup Menu” (see table 2-14).
Next Page	Page 2/2	Press this button to return to the first page.

Table 24 - Set Trigger Mode to Video Trigger Function Menu 1

Option	Setting	Instruction
Type	Alternative	The trigger signal comes from two vertical channels when you use alternative trigger. In this mode, you can observe two irrelative signals at the same time.
Source	CH1 CH2	Set trigger type information for CH1 signal. Set trigger type information for CH2 signal.
Mode	Video	Set trigger type of the vertical channel signal to Video trigger.



Polarity	 (Normal)  (Inverted)	<p>Normal triggers on the negative edge of the sync pulse.</p> <p>Inverted triggers on the positive edge of the sync pulse.</p>
Next Page	Page 1/2	Enter the second page of Alternative trigger menu.

Table 25 - Set Trigger Mode to Video Trigger Function Menu 2

Option	Setting	Instruction
Sync	All lines Line Num Odd field Even Field	Select appropriate video sync.
Standard	NTSC Pal/Secam	Select the video standard for sync and line number count.
Next Page	Page 1/2	Enter the second page of Alternative trigger menu.

Table 26 - Set Trigger Mode to Slope Trigger Function Menu 1

Option	Setting	Instruction
Type	Alternative	The trigger signal comes from two vertical channels when you use alternative trigger. In this mode, you can observe two irrelative signals at the same time.
Source	CH1 CH2	Set trigger type information for CH1 signal. Set trigger type information for CH2 signal.
Mode	Slope	Set trigger type of the vertical channel signal to slope trigger.



When		Select slope trigger condition.
Next Page	Page 1/2	Enter the second page of the alternative trigger.

Table 27 - Set Trigger Mode to Slope Trigger Function Menu 2

Option	Setting	Instruction
Time	 (Set time)	Turn the “Universal” knob to set the slope time. Time setup range is 20ns-10s.
Vertical		Select the trigger level that can be adjusted by “LEVEL” knob. You can adjust “LEVEL A”, “LEVEL B” or adjust them at the same time. Selections depend on slope trigger condition.
Set up		Enter the “Trigger setup menu” (see table 2-14).
Next Page	Page 2/2	Return the first page of “Alternative trigger menu”.

Operation Instructions:

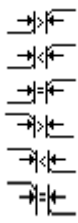
To observe two irrelative channel signals, follow these steps:

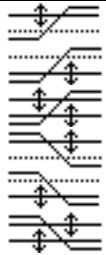
1. Input two irrelative signals to channel 1 and channel 2.
2. Press the AUTO button.
3. Press the TRIG MENU button to enter “trigger menu”.
4. Press the “Type” option button to select “Alternative”.
5. Press the “Channels” option button to select “CH1-CH2”
6. Press the “Source” option button to select “CH1”.
7. Press the CH1 button and turn the “time/div” knob to optimize waveform display.
8. Press “Mode” option button to select “Edge”, “Pulse”, “Slope” or “Video”.
9. Set the trigger according to trigger edge.
10. Press the “Source” option button to select “CH2”.
11. Press the CH2 button and turn the “time/div” knob to optimize waveform display.
12. Repeat steps 8 and 9.

Coupling

Use “Coupling” to make sure the signal passes through the trigger circuit.

It is useful for obtaining a steady wave form.

If you use trigger coupling, you should press the “TRIGGER” button and then select “Edge”, “Pulse”, “Video”, or “Slope” trigger. Then select the “coupling” option in the “Set Up menu”.

Position

The horizontal position control establishes the time between the trigger position and the screen center. You can adjust the horizontal “POSITION” knob control to view waveform data before the trigger, after the trigger, or some of each. When you change the horizontal position of a waveform, you are changing the time between the trigger and the center of the display actually. (This appears to move the waveform to the right or left on the display.)

Slope and Level

The Slope and Level controls help to define the trigger. The Slope option (Edge trigger type only) determines whether the oscilloscope finds the trigger point on the rising or the falling edge of a signal.

The **TRIGGER LEVEL** knob controls where on the edge the trigger point occurs.

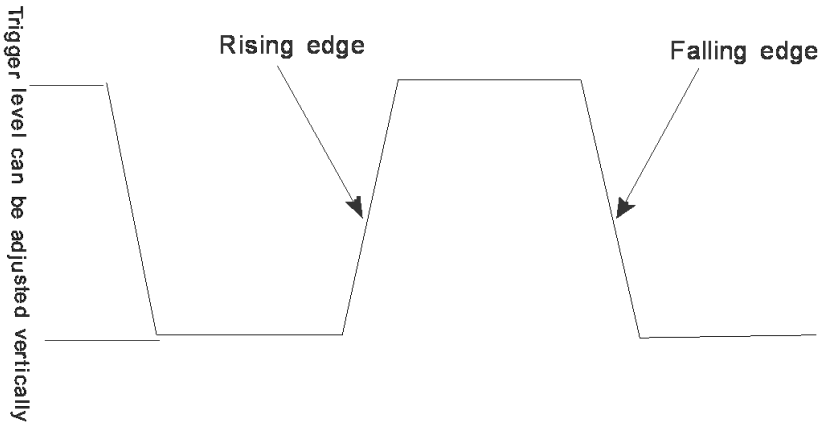

Figure 38 - Rise and Fall Edge

- Note:**
- Press the **SINGLE** button when you want the oscilloscope to acquire a single waveform.
 - Trigger coupling affects only the signal passed to the trigger system. It does not affect the bandwidth or coupling of the signal displayed on the screen.
 - Normal Polarity Sync triggers always occur on negative-going horizontal sync pulses. If the video waveform has positive-going horizontal sync pulses, use the Inverted Polarity selection.

Trigger Holdoff

You can use the Trigger Holdoff function to produce a stable display of complex waveforms. Holdoff is time between when the oscilloscope detects one trigger and when it is ready to detect another. The oscilloscope

will not trigger during the holdoff time. For a pulse train, you can adjust the holdoff time so the oscilloscope triggers only on the first pulse in the train.

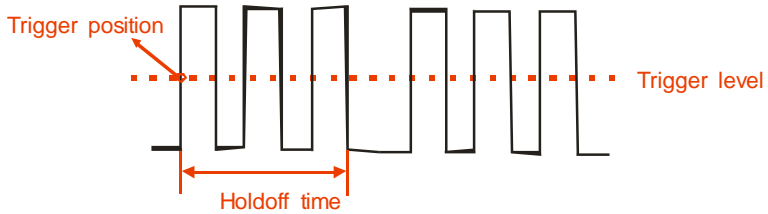

Figure 39 - Trigger Holdoff

If you want to change holdoff time, please follow the steps below:

1. Press the “TRIG MENU” button to show the “TRIG Menu”.
2. Press the “Type” option button to select trigger type.
3. Press the “Set Up” option button to enter the “Trigger setup menu”.
4. Press the “Holdoff” option button and turn the “Universal” knob to change the holdoff time until the waveform triggers steadily.

Note: • Use trigger holdoff to help stabilize the display of a periodic waveform.

Acquiring Signals System

Shown below is the “ACQUIRE” button for entering the menu for “Acquiring Signals”.

Table 28- Acquiring Signals Function Menu

Option	Setting	Introduction
Acquisition	Sampling	Use for sampling and accurately display most of the waveform.
	Peak Detect	Detect the noise and decrease the possibility of aliasing.
	Average	Use to reduce random or uncorrelated noise in the signal display.
	Averages (4, 16, 32, 64, 128, 256)	Select number of averages.
Sinx/x	On off	Use sin interpolation. Use linear interpolation.
Mode	Equ time Real time	Set the Sampling mode to Equ time. Set the Sampling mode to Real time.
Sa Rate		Display system sampling rate.

When you acquire a signal, the oscilloscope converts it into a digital form and displays a waveform. The acquisition mode defines how the signal is

digitized and the time base setting affects the time span and level of detail in the acquisition.

- **Sampling:** In this acquisition mode, the oscilloscope samples the signal in evenly spaced intervals to construct the waveform. This mode accurately represents signals most of the time.

Advantage: You can use this mode to reduce random noise.

Disadvantage: This mode does not acquire rapid variations in the signal that may occur between samples. This can result in aliasing, which may cause narrow pulses to be missed. In these cases, you should use the Peak Detect mode to acquire data.

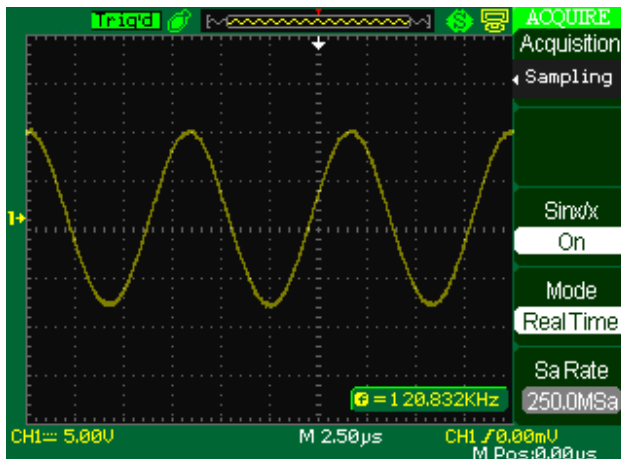

Figure 40 - Acquire Menu

- **Peak Detect:** Peak Detect mode capture the maximum and minimum values of a signal Finds highest and lowest record points over many acquisitions.

Advantage: In this way, the oscilloscope can acquire and display narrow pulses, which may have otherwise been missed in Sample mode.

Disadvantage: Noise will appear to be higher in this mode.

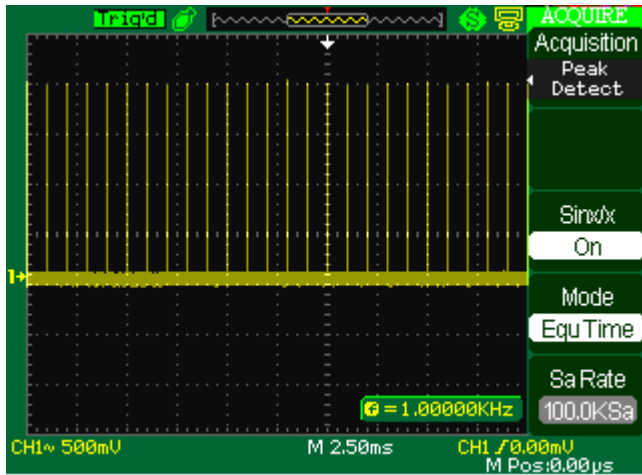

Figure 41 - Peak Detect

- **Average:** The oscilloscope acquires several waveforms, averages them, and displays the resulting waveform.

Advantage: You can use this mode to reduce random noise.

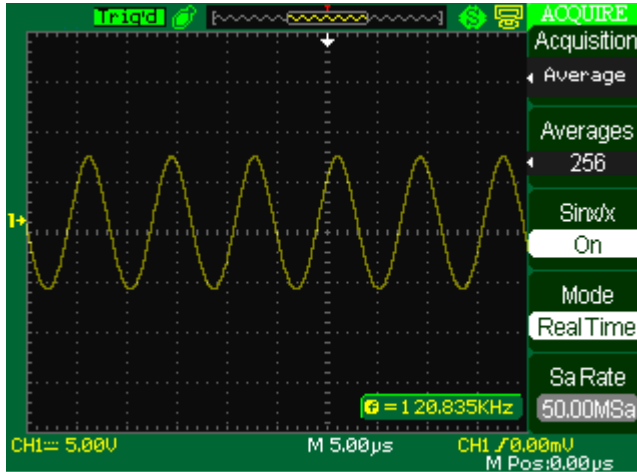

Figure 42 - Acquisition Averaging Screen

- **Equivalent Time Sampling:** The equivalent time sampling mode can achieve up to 10 GSa/s.
- **Real Time Sampling:** The oscilloscope's maximum real-time sampling rate is 500 MSa/s.
- **“RUN/STOP” Button:** Press the RUN/STOP button when you want the oscilloscope to acquire waveforms continuously. Press the button again to stop the acquisition.
- **“SINGLE” Button:** Press the SINGLE button to acquire a single waveform. Each time you push the SINGLE button, the oscilloscope begins to acquire another waveform. After the

oscilloscope detects a trigger it completes the acquisition and stops.

When you push the RUN/STOP or SINGLE buttons to start an acquisition, the oscilloscope goes through the following steps:

1. Acquire enough data to fill the portion of the waveform record to the left of the trigger point. This is also called the pre-trigger.
 2. Continue to acquire data while waiting for the trigger condition to occur.
 3. Detect the trigger condition.
 4. Continue to acquire data until the waveform record is full.
 5. Display the newly acquired waveform.
- **Time Base:** The oscilloscope digitizes waveforms by acquiring the value of an input signal at discrete points. The time base allows you to control how often the values are digitized. To adjust the time base to a horizontal scale that suits your purpose, use the time/div knob.
 - **Time Domain Aliasing:** Aliasing occurs when the oscilloscope does not sample the signal fast enough to construct an accurate waveform record. When this happens, the oscilloscope displays a

waveform with a frequency lower than the actual input waveform,
or triggers and displays an unstable waveform.

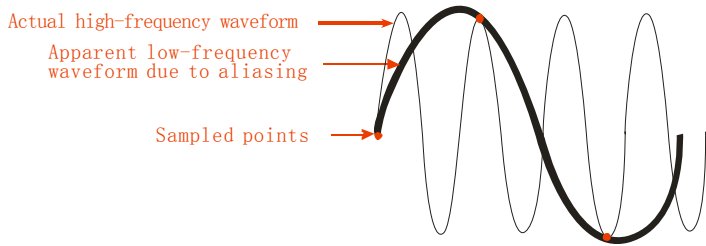

Figure 43 - Time Domain Aliasing

Operating Instructions:

Set up Sampling Format

You can press the “Acquisition” option button or turn the “Universal” knob to select “Sampling” mode, “Peak Detect” mode or “Average” mode.

Set up Averages

When you select “Average” format, you can press the “Averages” option button to select “4”, “16”, “32”, “64”, “128” or “256”.

Set up function interpolation

You can also turn Sinx/x interpolation on or off. Press the corresponding option button to turn Sinx/x on or off.

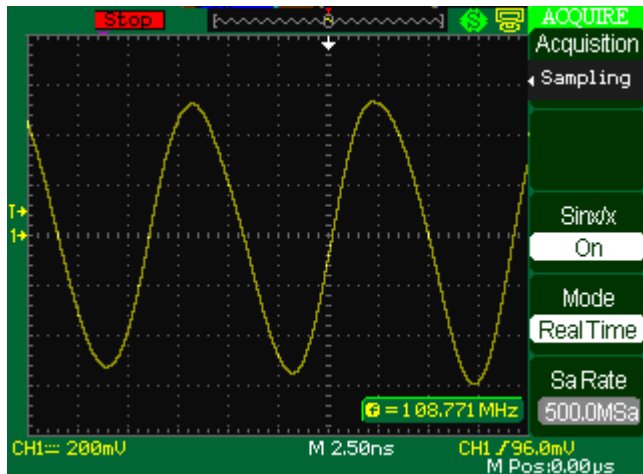

Figure 44 - "On" for Sine Interpolation

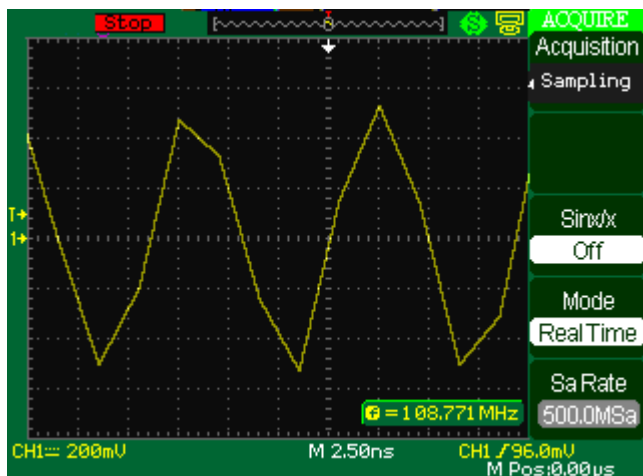

Figure 45 - "Off" for Linear Interpolation

Set up Sampling mode

Press the “Mode” option button to select “Real Time” or “Equ Time”.

Set up Sampling rate

Adjust the sampling rate by pressing the “Sa Rate” option button and turning the Time/div front panel knob. The sampling rate is shown at the corresponding timebase scale.

Display System

The display function could be expressed by the “DISPLAY” button.

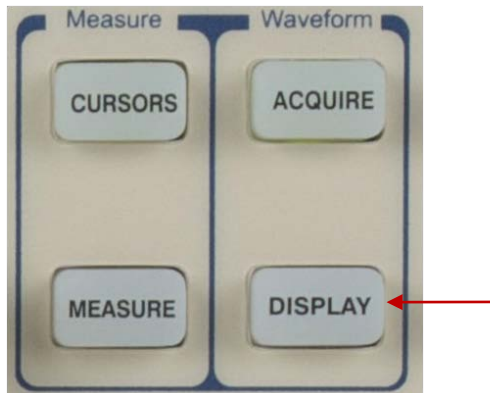



Table 29- Display System Function Menu 1

Option	Setting	Introduction
Type	Vectors Dots	Vectors: Fills the space between adjacent sample points in the display. Dots: There is no link between adjacent sample points.
Persist	Off 1 sec 2 sec 5 sec Infinite	Sets the length of time each displayed sample point remains displayed.
Intensity	 <Intensity>	Set waveforms' intensity.
Brightness	 <Brightness>	Set grid brightness.
Next Page	Page 1/3	Press this button to enter second page.

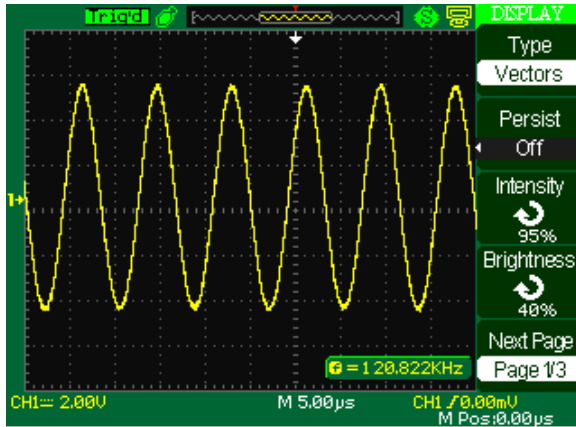
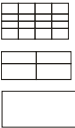

Figure 46 - Display Menu Screen

Table 30 - Display System Function Menu 2

Option	Setting	Introduction
Format	YT XY	YT format displays the vertical voltage in relation to time (horizontal scale). XY format displays a dot each time a sample is acquired on channel 1 and channel 2.
Screen	Normal Inverted	Set to normal mode. Set to invert color display mode.
Grid		Display grids and axes on the screen. Turn off the grids. Turn off the grids and axes.
Menu	2sec	Set menu display time on screen.

Display	5sec 10sec 20sec Infinite	
Next Page	Page 2/3	Press this button to enter the second page of “Display menu”.

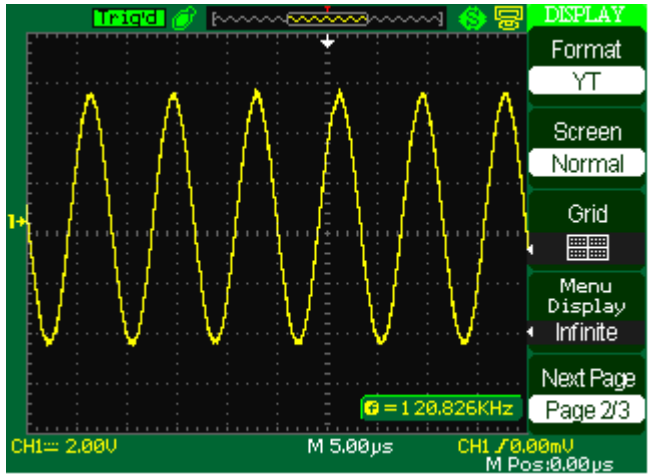

Figure 47 - Display Menu 2

Table 31 - Display System Function Menu 3

Option	Setting	Introduction
Skin	Classical Modern Tradition Succinct	Set up screen style.
Next Page	Page 3/3	Press this button to return the first page.

Operate Introduction:

Setup waveform display type

1. Press the “DISPLAY” button to enter the “Display” menu.
2. Press the “Type” option button to select “Vectors” or “Dots”.

Set up Persist

Press the “Persist” option button to select “Off”, “1 Sec”, “2 Sec”, “5 Sec” or “Infinite”. You can use this option to observe some special waveforms.

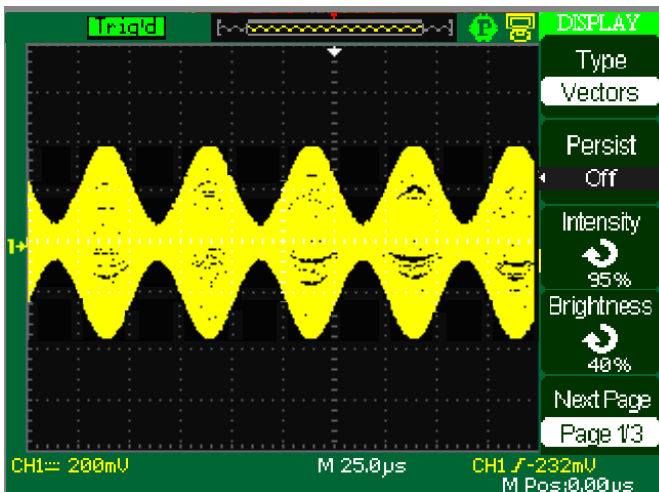

Figure 48 - Persist Screen

Setup Intensity

Press the “Intensity” option button and turn the “Universal” knob to adjust waveforms’ intensity.



Setup Brightness

Press the “Brightness” option button and turn the “Universal” knob to adjust grid brightness.

Setup Display Format

1. Press the “Next Page” option button to enter second display menu.
2. Press the “Format” option button to select “YT” or “XY”

Setup Grid

Press the “Grid” option button to select “  ”, “  ” or “  ” to set the screen whether to display grid or not.

Setup Menu Display

Press the “Menu Display” option button to select “2 sec”, “5 sec”, “10 sec”, “20 sec”, or “Infinite” to set menu display time on screen.

Set Skin

Press the “skin” option button or turn the “Universal” knob to select “Classical”, “Modern”, “Traditional”, or “Succinct”.

X-Y Format

Use the XY format to analyze phase differences, such as those represented by Lissajous patterns. The format plots the voltage on channel 1 against the voltage on channel 2, where channel 1 is the horizontal axis and channel 2 is the vertical axis. The oscilloscope uses the untriggered Sample acquisition mode and displays data as dots.

Note: The oscilloscope can capture a waveform in normal YT mode at any sampling rate. You can view the same waveform in XY mode. To do so, stop the acquisition and change the display format to XY.

Operation steps:

- Channel 1 “Volt/div” and vertical “POSITION” set up the horizontal scale and position.
- Channel 2 “Volt/div” and vertical “POSITION” set up

the horizontal scale and position.

- Turn the “time/div” knob to adjust the sampling rate
- The following functions are forbidden at XY display

form:

- Benchmark waveform and wave mathematics
- Cursor
- Auto (resets display format to YT)
- Trigger Control
- Horizontal Position Knob
- Vector Display Type
- Scan Display

Note: When the display type is set to Vector, the oscilloscope connects the sample points by using digital interpolation. Interpolation mode contains linear interpolation and $\sin(x)/x$ interpolation. $\sin(x)/x$ interpolation is suitable for reconstructing curved or irregular wave shapes, especially when the sample rate is 3 to 5 times the system bandwidth or at faster time base settings.

Measure System

The oscilloscope displays the voltage in relation to time and test the waveform displayed. There are scale, cursor, and auto measure modes.

Scale Measurement

This method allows you to make a quick visual estimate. For example, you might look at waveform amplitude and determine that it is a little more than 100 mV. You can take simple measurements by counting the major and minor graticule divisions involved and multiplying by the scale factor. For example, if you counted five major vertical graticule divisions between minimum and maximum values of a waveform and knew you had a scale factor of 100 mV/div, then you could easily calculate your peak-to-peak voltage as follows:

$$5 \text{ divisions} \times 100 \text{ mV/div} = 500 \text{ mV}$$

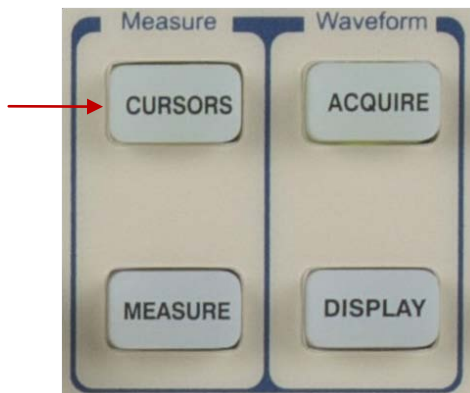

Cursor Measurement

The cursor measurement has three modes: Manual, Track, and Auto Measure.



Manual Mode

Table 32 - Manual Cursor Function Menu

Option	Setting	Instruction
Cursor Mode	Manual	In this menu, set the manual cursor measure.
Type	Voltage Time	Use cursor to measure voltage parameters. Use cursor to measure time parameters.
Source	CH1 CH2 MATH/FFT REFA REFB	Select input signal channel.
Cur A 		Select this option, turn the “Universal” knob to adjust cursor A.
Cur B 		Select this option, turn the “Universal” knob to adjust cursor B.

In this mode, the screen displays two horizontal parallel cursors or vertical parallel cursors to measure voltage or time. You can move the cursor by turning the “Universal” knob. Before using cursors, you should make sure that you have set the signal source as the channel for measuring.

- **Voltage Cursor:** Voltage cursors appear as horizontal lines on the display and measure the vertical parameters.
- **Time Cursor:** Time cursors appear as vertical lines on the display and measure the horizontal parameters.
- **Cursor Moving:** Use the “Universal” knob to move cursor 1 and cursor 2. They will be moved when the corresponding cursor options are selected, and the cursor value will display on the bottom left and top left of the screen when you move the cursor.

To do manual cursor measurements, follow these steps:

1. Press CURSOR button to enter the cursor function menu.
2. Press the “Cursor Mode” option button to select “Manual”.
3. Press the “Type” option button to select “Voltage” or “Time”.
4. Press the “Source” option button to select “CH1”, and “CH2”, “MATH”, “FFT”, “REFA”, “REFB” according to input signal channel.
5. Select “Cur A” and turn the “Universal” knob to adjust Cursor A.
6. Select “Cur B” and turn the “Universal” knob to adjust Cursor B.
7. The measurement values are displayed on the top left corner.
 If the measurement type is set to “Voltage”, the values are as follows:
 The value of Cur A: Cur A
 The value of Cur B: Cur B
 The voltage increment between Cursor A and Cursor B: ΔV
 If the measurement type is set to “Time”, the values are as follows:
 The value of Cur A: Cur A
 The value of Cur B: Cur B
 The time increment between Cursor A and Cursor B: ΔT
 The reciprocal of time increment between Cursor A and Cursor B: $1/\Delta T$

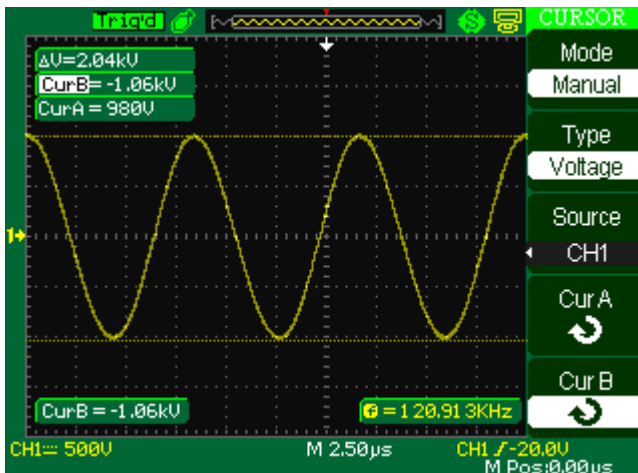



Figure 49 - Cursor Menu

Track Mode

Table 33- Track Mode Function Menu

Option	Setting	Instruction
Cursor Mode	Track	In this mode, set track cursor measure.
Cursor A	CH1 CH2 NONE	Set the input signal channel that the Cursor A will measure.
Cursor B	CH1 CH2 NONE	Set the input signal channel that the Cursor B will measure.
Cur A 		Select this option, turn the “Universal” knob to adjust horizontal coordinate of Cursor A.
Cur B 		Select this option, turn the “Universal” knob to adjust horizontal coordinate of Cursor B.

In this mode, the screen displays two cross cursors. The cross cursor sets the position on the waveform automatically. You could adjust the cursor’s horizontal position on the waveform by turning the “Universal” knob. The oscilloscope displays the values on the top left of the screen.

To do track cursor measurement, follow these steps:

1. Press CURSOR button to enter the cursor measure function menu.
2. Press the “Cursor Mode” option button to select “Track”.
3. Press the “Cursor A” option button to select the input signal channel.

4. Press the “Cursor B” option button to select the input signal channel.
5. Select “Cur A”, turn the “Universal” knob to move Cursor A horizontally.
6. Select “Cur B”, turn the “Universal” knob to move Cursor B horizontally.
7. The measurement values are displayed on the left of the top corner:

A → T: The horizontal position of Cursor A (Time cursor centered around the midpoint of screen)

A → V: The vertical position of Cursor A (Voltage cursor centered around channel ground level)

B → T: The horizontal position of Cursor B (Time cursor centered around the midpoint of the screen)

B → V: The vertical position of Cursor B (Voltage cursor centered around the channel ground level)

ΔT : Horizontal space between Cursor A and Cursor B (Time value between two cursors).

$1/\Delta T$: The reciprocal of horizontal space between cursor A and cursor B.

ΔV : Vertical space between Cursor A and Cursor B (Voltage value between two cursors).

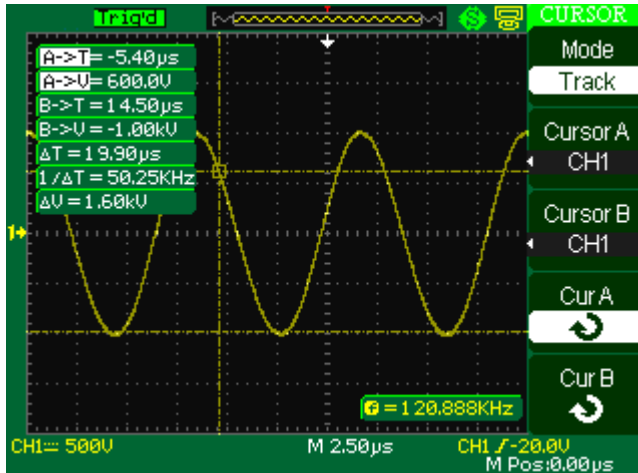

Figure 50 - Cursor Menu

Auto Mode

Table 34 - Auto Mode Function Menu

Option	Setting	Instruction
Cursor Mode	Auto	Set to auto cursor measure mode.

This mode will take effect with automatic measurements. The instruments will display cursors while measuring parameters automatically. These cursors demonstrate the physical meanings of these measurements.

To do auto cursor measurements, follow these steps:

1. Press the CURSOR button to enter “Cursor measure menu”.
2. Press the “Cursor Mode” option button to select “Auto”.

Press the “MEASURE” button to enter “Auto cursor measure mode menu” to select the parameter that you want to measure.

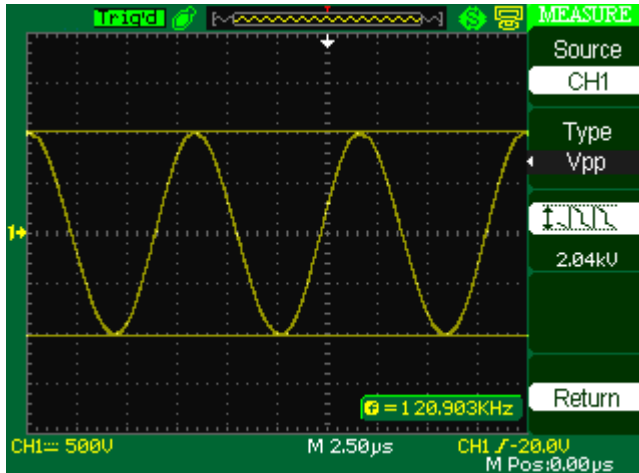
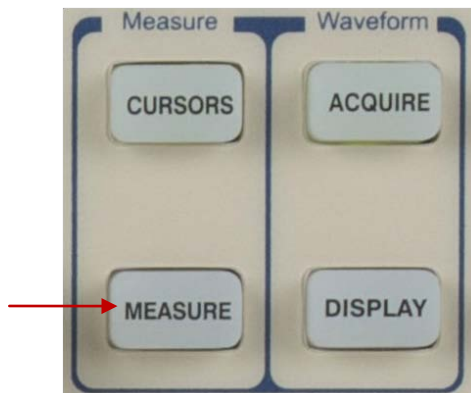

Figure 51 - Auto Mode

Auto Measurement

“MEASURE” button as shown below enters the “Automatic Measure Function Menu”.



When you take automatic measurements, the oscilloscope does all the calculation for you. The measurements use all the recorded points in the memory, which are more accurate than measurements made using the graticule lines or cursor measurements because these measurements are confined to be made by only using points on the display and not all the data points recorded by the oscilloscope.

Press the 'MEASURE' button for Automatic Test.

There are three auto measurement types: Voltage Measure, Time Measure, and Delay Measure. There are a total of 32 measurement parameters.

Table 35 - Auto Measure Function Menu 1

Option	Instruction
Voltage	Press this button to enter the Voltage measure menu.
Time	Press this button to enter the Time measure menu.
Delay	Press this button to enter the Delay measure menu.
All Mea	Press this button to enter the All Measurement menu.
Return	Press this option button to return the home page of the auto measure menu.

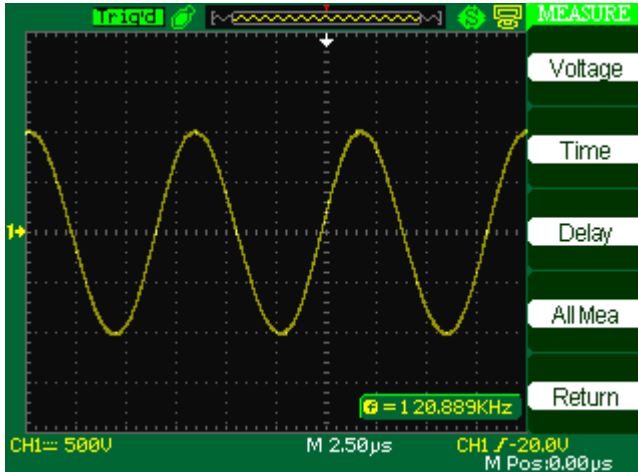

Figure 52 - Auto Measure Menu 1

Table 36 - Auto Measure Function 2 - Voltage Measure Menu

Option	Setting	Instruction
Source	CH1, CH2	Select input signal source for Voltage measure.
Type	Vpp, Vmax, Vmin, Vamp, Vtop, Vbase, Vavg, Mean, , Vrms, Cycle Vrms, FOVShoot, FPREShoot, ROVShoot, RPREShoot,	Press the “Type” button or turn the “Universal” knob to select Voltage measure parameter.
		Display the corresponding icon and measure value of your selected Voltage measure parameter.
Return		Return to the first page of auto measurement menu.

Table 37 - Auto Measure Function 3 - Time Measure Menu



Option	Setting	Instruction
Source	CH1, CH2, MATH, REFA, REFB	Select input signal source for Time measure.
Type	Freq, Period, +Width, -Width, Rise Time, Fall Time, BWidth, +Duty, -Duty	Press the “Type” button or turn the “Universal” knob to select Time measure parameter.
		Display the corresponding icon and measure value of your selected time measure parameter.
Return		Return to the first page of auto measurement menu.

Table 38 - Auto Measure Function 4 - Delay Measure Menu

Option	Setting	Instruction
Source	CH1, CH2, MATH, REFA, REFB	Select any two input signal source for Delay measure.
Type	Phase, FRR, FRF, FFR, FFF, LRR, LRF, LFR, LFF	Press the “Type” button or turn the “Universal” knob to select Delay measure parameter.
		Display the corresponding icon and measure value of your selected Delay measure parameter.

Return		Return to the first page of auto measurement menu.
--------	---	--

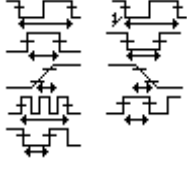
Table 39 - All Measurement Function Menu































Option	Setting	Instruction
Source	CH1 CH2	Select input signal channel.
Voltage	On Off	Turn on the all measurement function to measure voltage parameters. Turn of the all measurement function to measure voltage parameters.
Time	On Off	Turn on the all measurement function to measure Time parameters. Turn of the all measurement function to measure Time parameters.
Delay	On Off	Turn on the all measurement function to measure Delay parameters. Turn of the all measurement function to measure Delay parameters.
Return		Return to the “All Measure main menu”.

Table 40 – Introduction of the Measure Type

Measure Type	Introduction
 Vpp	Measures the absolute difference between the maximum and minimum peaks of the entire waveform.
 Vmax	The most positive peak voltage measured over the entire waveform.
 Vmin	The most negative peak voltage measured over the entire waveform.
 Vamp	Voltage between Vhigh and Vlow of a waveform.
 Vmax	Measures the highest voltage over the entire

Vtop	waveform.
 Vbase	Measures the lowest voltage over the entire waveform.
 Vavg	The arithmetic mean over the first cycle in the waveform.
 Mean	The arithmetic mean over the entire waveform.
 Crms	The true Root Mean Square voltage over the first cycle in the waveform.
 Vrms	The true Root Mean Square voltage over the entire waveform.
 ROVShoot	Defined as $(V_{max}-V_{hig})/V_{amp}$ after the waveform rising.
 FOVShoot	Defined as $(V_{min}-V_{low})/V_{amp}$ after the waveform falling.
 RPREshoot	Defined as $(V_{min}-V_{low})/V_{amp}$ before the waveform rising.
 FPREShoot	Defined as $(V_{max}-V_{hig})/V_{amp}$ before the waveform falling.
FREQ	Measures the frequency of the waveform.
PRD	Measures the period of the waveform.
 Rise Time	Rise Time Measures the time between 10% and 90% of the first rising edge of the waveform.
 Fall Time	Fall Time Measures the time between 90% and 10% of the first falling edge of the waveform.
 BWid	The duration of a burst. Measured over the entire waveform.
 + Wid	+ Width Measures the time between the first rising edge and the next falling edge at the waveform 50% level.

 - Wid	-Width Measures the time between the first falling edge and the next rising edge at the waveform 50% level.
 + Duty	Measures the first cycle waveform. Positive Duty Cycle is the ratio between positive pulse width and period.
 -Duty	Measures the first cycle waveform. Negative Duty Cycle is the ratio between negative pulse width and period.
 Phase	The amount one waveform leads or lags another in time. Expressed in degrees, where 360 degrees comprise one waveform cycle.
 FRR	The time between the first rising edge of source 1 and the first rising edge of source 2.
 FRF	The time between the first rising edge of source 1 and the first falling edge of source 2.
 FFR	The time between the first falling edge of source 1 and the first rising edge of source 2.
 FFF	The time between the first falling edge of source 1 and the first falling edge of source 2.
 LRR	The time between the first rising edge of source 1 and the last rising edge of source 2.
 LRF	The time between the first rising edge of source 1 and the last falling edge of source 2.
 LFR	The time between the first falling edge of source 1 and the last rising edge of source 2.
 LFF	The time between the first falling edge of source 1 and the last falling edge of source 2.

If you want to measure voltage parameters, please follow the steps below:

1. Press the “MEASURE” button to enter the “Auto measurement” menu.

2. Press the top first option button to enter the “second measurement menu”.
3. Select measure type. If you press the “Voltage” option button, “Voltage measurement” menu will display on the screen.
4. Press the “Source” option button to select “CH1”, “CH2” according to input signal channel.
5. Press the “Type” option button to select the parameter type that you want to measure. The corresponding icon and value will display below the measure parameter.

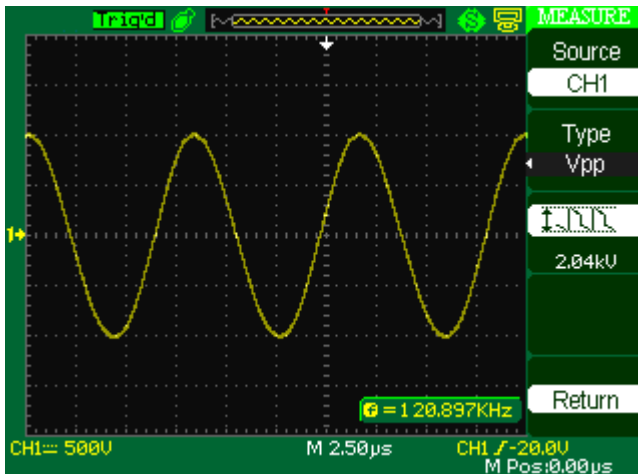

Figure 53 - Measure Voltage Parameters

6. Press the “Return” option button to return to the home page of the “Auto Measurement” menu. The selected parameter and the corresponding value will display on the top position of the home page.

You can display the other parameters and its' value on the corresponding position in the same way. The screen can display up to five parameters at one time.

If you want to measure time parameters using all measure function, please follow these steps:

1. Press the “MEASURE” button to enter the “Auto Measure menu”.
2. Press the top option button to enter the second page of “Auto Measure menu”.
3. Press “All Mea” option button to enter the “All Measure menu”.
4. Press “Source” option button to select input signal channel.
5. Press the “Time” option button to select “On”. Now all of time parameters value will display on the screen at the same time.

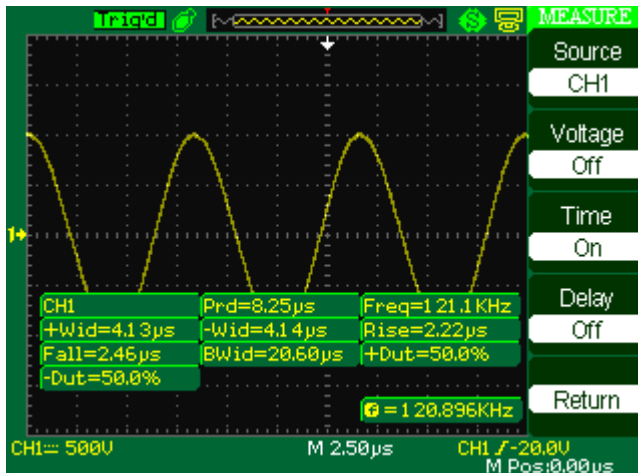

Figure 54 - Measure Time Parameters

Storage System

Shown below, the “SAVE/RECALL” button enters the “Storage System Function Menu”.



The scope can save 2 groups’ reference waveforms, 20 groups’ setups, and 10 waveforms to the oscilloscope’s internal memory. There is a USB Host interface in the front panel of the oscilloscope where you can save setup data, waveform data, waveform interface image, CSV file to a USB flash drive. Setup data and waveform data can be recalled to the oscilloscope. Picture data and CSV file can’t be recalled to the oscilloscope, but it can be opened on a computer.

- Using SAVE ALL Screen
The SAVE ALL screen is divided into functions based on Directories or Files. Directories show option buttons for **New Folder**, **Del Folder**, and **Load**. While File shows option buttons for **New Folder**, **Delete File**, and **Load**.

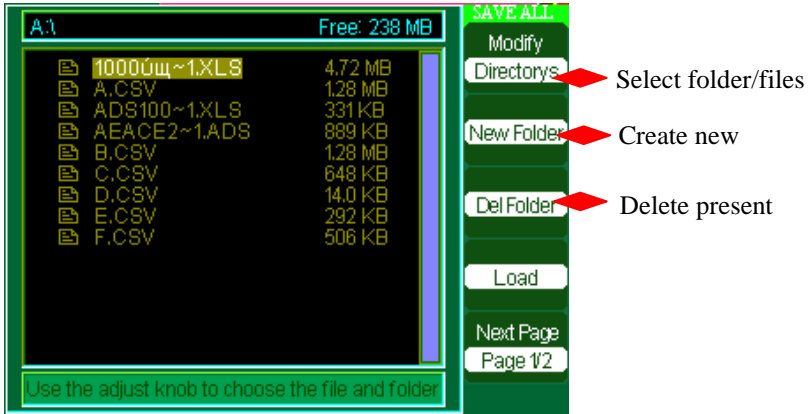

Figure 55 - Save All Menu Screen 1

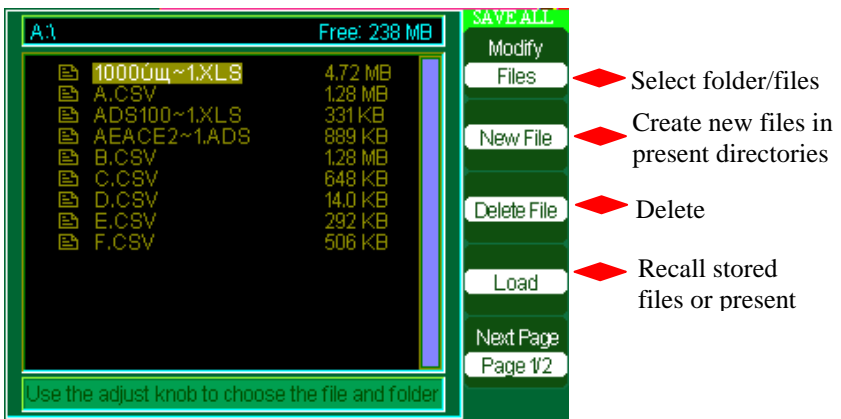

Figure 56 - Save All Menu Screen 2

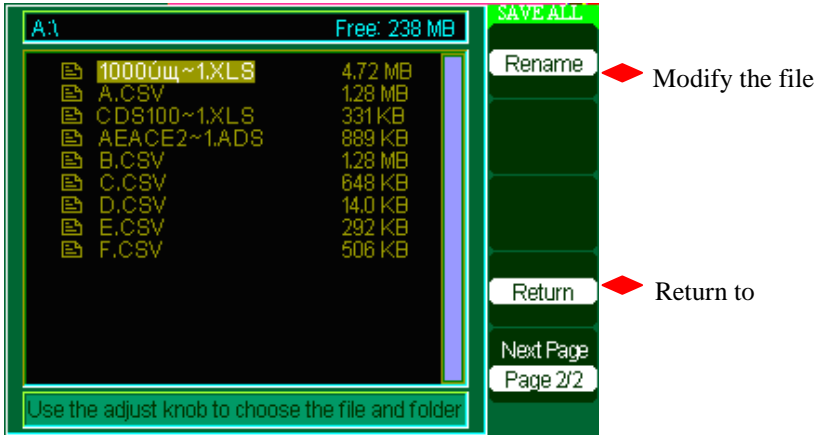

Figure 57 - Save All Menu Screen 3

Recalling Files

The Load button is used to recall your setup files. Once you've navigated to the desired file and it's highlighted in the main screen area, press the Load option button and the setup is recalled from the USB flash drive.

Note: The Load button option is disabled (grayed-out) when Pictures or .csv file types are selected as Type.

Both Directory and Files have Rename and Return option buttons on Page 2/2. Use these buttons to give an existing folder or file a new name or to exit the SAVE ALL screen, respectively.

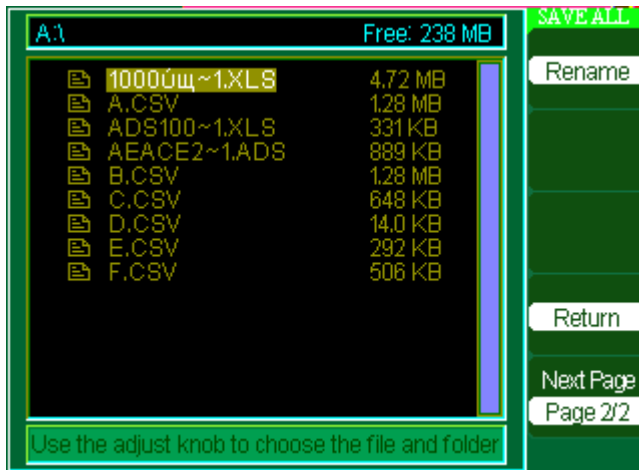

Figure 58 - Save All Rename Screen

Creating Folders and Files

Create new folders and files by pressing the **New Folder** or **New File** option button. The following screen is shown:

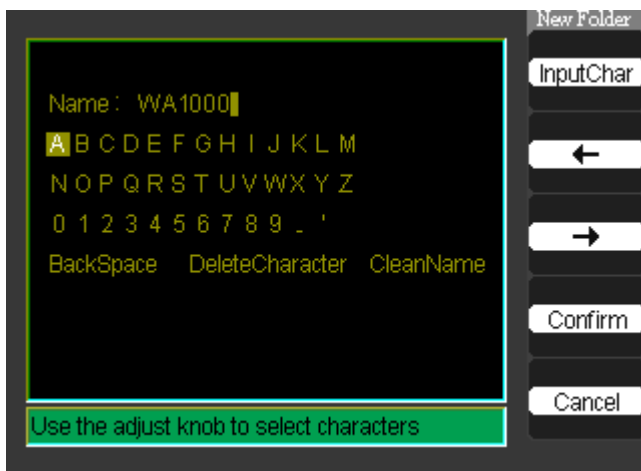

Figure 59 - Input Characters Screen

- The New File menu choices and behavior is the same as the **New Folder** menu. It just has a different heading. The InputChar option button adds the selected character to the cursor position in Name field.
- Move the cursor position in the name field using the “→” and “←” option buttons.
- Turn the “Universal” knob to move through character selections. When the desired character is highlighted, press the “Universal” knob or press the “InputChar” option button to add it to the specific position in the Name field.
- Additional selections for BackSpace, DeleteCharacter, and CleanName are available for convenience and are also accessed using the “Universal” knob in the same manner.
- Press the “Confirm” option button (when you have the Name field completed as desired) to save the file onto the memory device. After the “Confirm” option button is pressed, a “Data Store Success!” message is briefly shown and the new folder or file is shown on your USB flash drive.

Save/Recall Setup

- Save Setups to Device:** The complete setup is stored in nonvolatile memory. When you recall the setup, the oscilloscope will be in the mode from which the setup was saved. The oscilloscope saves the current setup if you wait three seconds after the last change before you power off the oscilloscope. The oscilloscope recalls this setup the next time you apply power.

Table 41 - Save Setup to Device Function Menu

Option	Setting	Introduction
Type	Setups	Menu for the Storage/Recall setting in the oscilloscope
Save to	Device	Save setup to the oscilloscope's internal memorizer.
Setup	No.1 to No.20	Press the "Setup" option button or turn the "universal" knob to select storage position.
Save		Accomplish the storage
Recall		Recall the storage in the "Setup" operation

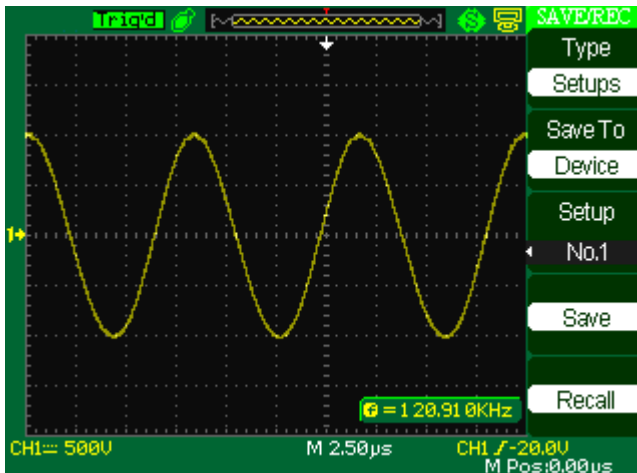

Figure 60 - Save/Rec Menu

To save setups to the oscilloscope's internal memory, follow the steps below:

For example: Save setup that set waveform display type to "Dots" to internal memory.

1. Press the "SAVE/RECALL" button to enter the "SAVE/RECALL" menu.
2. Press the "Type" option button to select "setups".
3. Press the "Save to" option button to select "Device".
4. Press the "Setup" option button to select "No.1".
5. Press the "DISPLAY" button to enter the "Display" menu.
6. Press the "Type" option button to select "Dots".
7. Press the "SAVE/RECALL" button to enter the "SAVE/RECALL" menu.
8. Press the "Save" option button.

To Recall setup, follow below:

1. Press the "SAVE/RECALL" button to enter the "SAVE/RECALL" display menu.
2. Press the "Type" option button to select "Setups".
3. Press the "Save to" option button to select "Device".
4. Press the "Setup" option button or turn the "Universal" knob to select "No.1".

5. Press the “Recall” option button.

- **Save Setup to USB Flash Drive**

Table 42 - Save Setup to USB Flash Drive Function Menu

Option	Setting	Introduction
Type	Setups	Menu for the Storage/Recall settings.
Save to	File	Save setup data to USB flash drive.
Save		Go to the Save/Recall interface

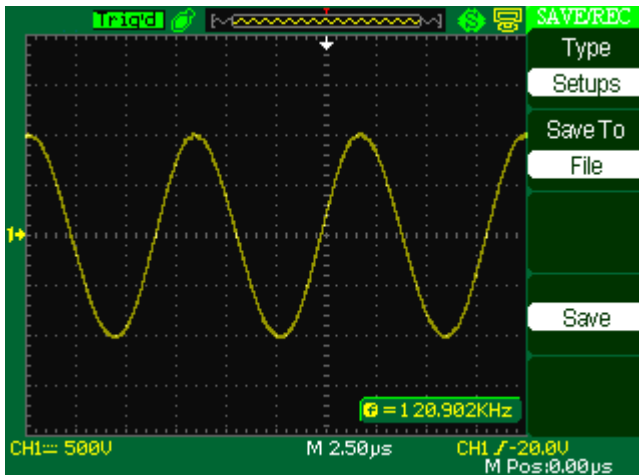

Figure 61 - Save Setup Screen

Save Setup to USB Flash drive:

For example: Save setup that set waveform display type to “Dots” to USB flash drive.

1. Press the “SAVE/RECALL” button to select “Setups”.

2. Insert USB flash drive to USB host port of the oscilloscope and wait until the oscilloscope has initialized USB flash drive (about five second).
3. Press the “Save to” option button to select “file”.
4. Press the “Save” option button to go into the Save/Recall interface.
5. Press the “New folder” button to create a new folder
6. Press the “Del folder” option button to delete a folder
7. Press the “Modify” option button to modify a folder.
8. Press the “New file” option button to create a new file
9. Press the “Del file” option button to delete a file
10. Press “the next page” option button and press the “Rename” option button to modify the name of the file or the folder.
11. Turn the “Universal” knob to select the folder and press the “Confirm” option button and you will save the set to the USB drive.

To Recall setup data from USB flash drive, do the following:

1. Press the “SAVE/RECALL” button.
2. Press the “Type” button to select “Setups”.
3. Insert USB flash drive to USB host port of the oscilloscope and wait until the oscilloscope has initialized USB flash drive (about

five seconds).

4. Press the “Save to” option button to select “File”.
5. Press the “Save” option button then you’ll go into the Save/Recall interface.
6. Choose the file you want then press the “Load” option button (about five seconds, there is a prompting message that shows “Read data success”), now setup data have been recalled from USB flash drive.

- **Recall Factory**

You can use this option to recall factory settings.

Table 43 - Factory Function Menu

Option	Setting	Instruction
Type	Factory	To view the Factory setup.
	Load	Recall the Factory setup.

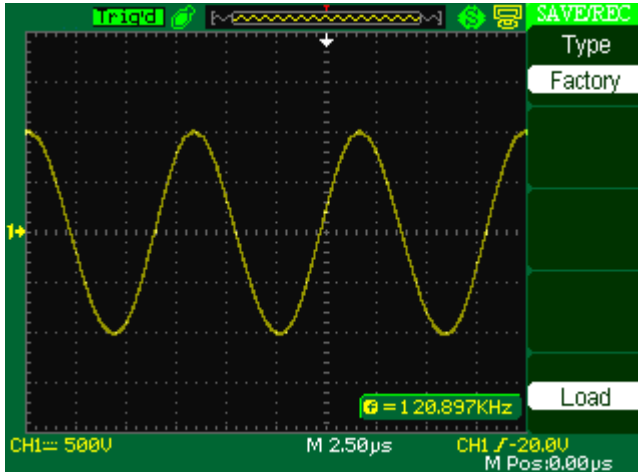

Figure 62 - Set Factory Default Screen

Save/Recall Waveform

Save Waveforms to Device

Table 44 - Save Waveform to Device Function Menu

Option	Setup	Introduction
Type	waveforms	Menu for the Storage/Recall waveforms in the oscilloscope.
Save to	Device	Save waveforms to the oscilloscope's internal memorizer.
waveform	No.1 to No.10	Press the "waveform" option button or turn the "Universal" knob to select storage position.
Save		Accomplish the storage.
Recall		Recall the storage in the "waveform" operation

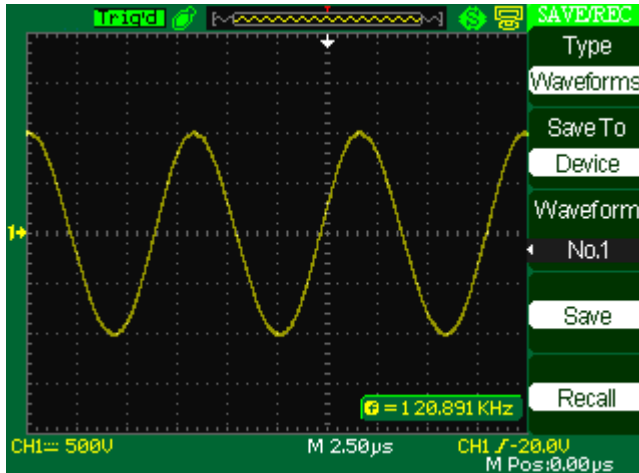

Figure 63 - Save Waveform Menu Screen

To save waveforms in internal memory, do the following:

1. Input a sine signal to channel 1 and press the “Auto” button.
2. Press the “SAVE/RECALL” button to enter “SAVE/RECALL” display menu.
3. Press the “Type” option button to select “waveforms”.
4. Press the “Save to” option button to select “Device”.
5. Press the “waveform” option button or turn the “Universal” knob to select “No.1”.
6. Turn the “Volts/div” knob or “Time/div” knob to adjust the waveform that you want.
7. Press the “Save” option button.

To recall waveforms, do the following:

1. Press the “SAVE/RECALL” button to enter “SAVE/RECALL” display menu.
2. Press the “Type” option button to select “waveforms”.
3. Press the “Save to” option button to select “Device”.
4. Press the “waveform” option button or turn the “Universal” knob to select “No.1”.
5. Press the “Recall” option button.

Save Waveforms to USB Flash Drive

Table 45 - Save Waveforms to USB Flash Drive Function Menu

Option	Setup	Introduction
Type	Waveforms	Menu for the Storage/Recall waveforms.
Save to	File	Save waveforms to USB flash drive.
Save		Accomplish the storage.

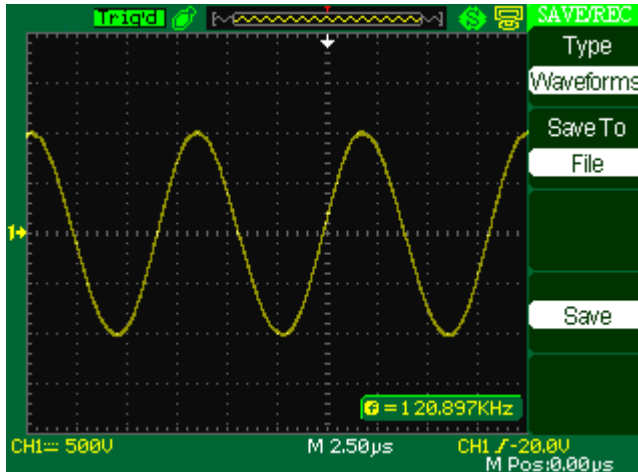

Figure 64 - Save Waveforms Screen

Save waveforms to USB flash drive, follow next steps:

1. Input a sine signal to channel 1, press the “AUTO” button.
2. Press the “SAVE/RECALL” button to enter the “SAVE/RECALL” display menu.
3. Press the “Type” option button to select “Waveforms”.
4. Insert USB flash drive to USB host port of the oscilloscope and wait until the oscilloscope has initialized USB flash drive (about five seconds).
5. Press the “Save to” option button to select “File”.
6. Press the “Save” option button then you’ll go into the Save/Recall interface.
7. Create a file then press the “Confirm” button (about five seconds, there is a prompting message showing “Save data success” displaying on the screen), now waveform data have been saved to USB flash drive.

Recall waveforms form USB flash drive, follow next steps:

1. Press the “SAVE/RECALL” button.
2. Press the “Type” button to select “Waveforms”.
3. Insert USB flash drive to USB host port of the oscilloscope and wait until the oscilloscope has initialized USB flash drive (about ten seconds).
4. Press the “Save to” option button to select “File”.
5. Press the “Save” option button then go into the Save/Recall interface.
6. Choose the file you want then press the “Load” option button (about five seconds, there is a prompting message showing “Recall data success” displaying on the screen), now waveform data have been recalled from USB flash drive.

Save Picture

Waveform interface image can be saved to USB flash drive, but they cannot be recalled. Images can be opened on a computer.

Table 46 - Picture Storage Function Menu

Option	Setting	Introduction
Type	Pictures	Menu for the Storage/Recall waveform interface image.
Print Key	Print Picture	Not available

	Save Picture	When the USB flash drive insert to the USB Host interface (now the USB flash drive open status icon displays on the top of the screen), select “Save picture” and press the “Save” knob to go into the Save/Recall interface.
Save		Go to the Save/Recall interface.

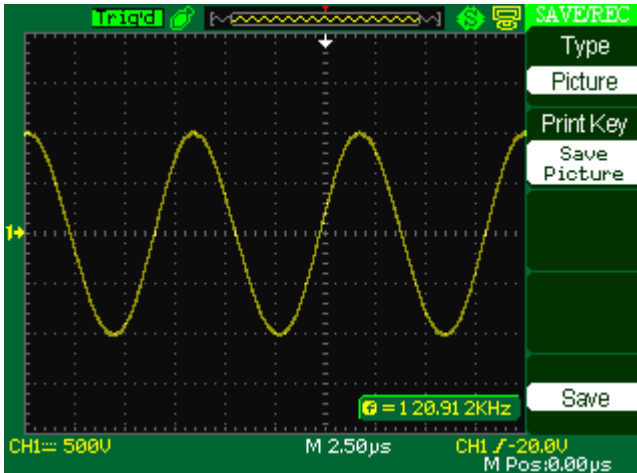

Figure 65 - Save Picture Screen

To save waveform image to USB flash drive, do the following:

1. Select the screen image that you want.
2. Press the “SAVE/RECALL” button to enter “SAVE/RECALL” menu.
3. Press the “Type” option button to select “Pictures”.

4. Insert USB flash drive to USB host port of the oscilloscope and wait until the oscilloscope has initialized USB flash drive (about five seconds).
5. Press the “Print Key” option button to select “Save Picture”.
6. Press the “Save” option button then go into the Save/Recall interface”.
7. Press the “Save” button then you’ll go into the Save/Recall interface
8. Create the picture name then press the “Confirm” button (about five seconds, there is a prompting message showing “Save data success” displaying on the screen), now picture data have been saved to USB flash drive.

Save/Recall CSV

Table 47 - CSV Storage Function Menu

Option	Setting	Introduction
Type	CSV	Menu for the Storage CSV file to USB flash drive.
Data Depth	Displayed Maximum	Set to store displayed waveform data to CSV file. Set to store maximum waveform data to CSV file.
Para Save	On Off	Set whether store parameters to CSV file or not.
Save		Go to the Save/Recall interface.

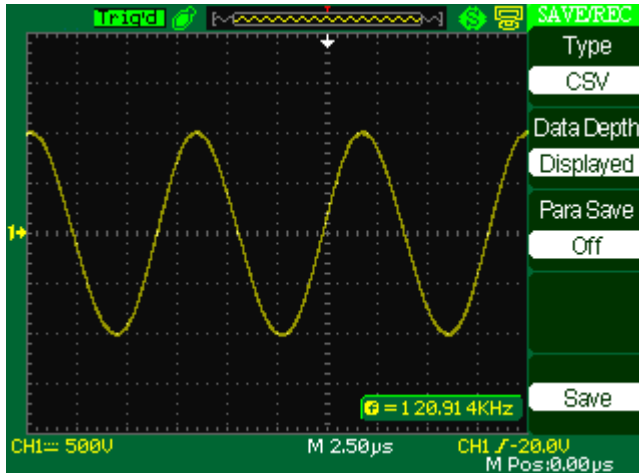

Figure 66 - Save to CSV Screen

To save CSV file to USB flash drive, do the following:

1. Press the “SAVE/RECALL” button to enter “SAVE/RECALL” menu.
2. Press the “Type” option button to select “CSV”.
3. Insert USB flash drive to USB host port of the oscilloscope and wait that the oscilloscope has initialized USB flash drive (about five seconds).
4. Press the “Data Depth” option button to select “Displayed” or “Maximum”.
5. Press the “Para Save” option button to select “On” or “Off”.
6. Press the “Save” option button then you’ll go into the Save/Recall interface

7. Create a file name then press the “Confirm” button (About five seconds, there is a prompting message showing “Save data success” displaying on the screen), now CSV file has been saved to USB flash drive.

Note: The maximum number of data points of a waveform that can be saved as a CSV file into USB drive is ~32768 pts (depending on the timebase setting) when data depth is set to maximum. The actual number depends on the time base setting and whether data depth is set to “display” or “maximum” See below table for maximum data points available in each timebase when data depth is set to maximum.

	Number of points saved to CSV file (data depth set to maximum)	
Time base	Single channel operation	Dual channel operation
50 s – 100 ns	16 k	16 k
50 ns – 25 ns	32 k	16 k



Note: 32 k refers to 32768 points, 16 k refers to 16384 points

Utility System

“UTILITY” system button is located as shown below:



Table 48 - Utility System Function Menu 1

Option	Setting	Introduction
System Status		Displays summaries of the oscilloscope settings.
Sound	  	Open the key-press voice. Close the key-press voice.
Counter	On Off	Turn on Frequency Counter Turn off Frequency Counter.
Language	简体中文 繁體中文 English Français 日本語 한국어 Deutsch Español Русский Italiana Português العربية	Simplified Chinese Traditional Chinese English French Japanese Korean German Spanish Russian Italian Portuguese Arabic

Next Page	Page 1/4	Press this button to enter second page.

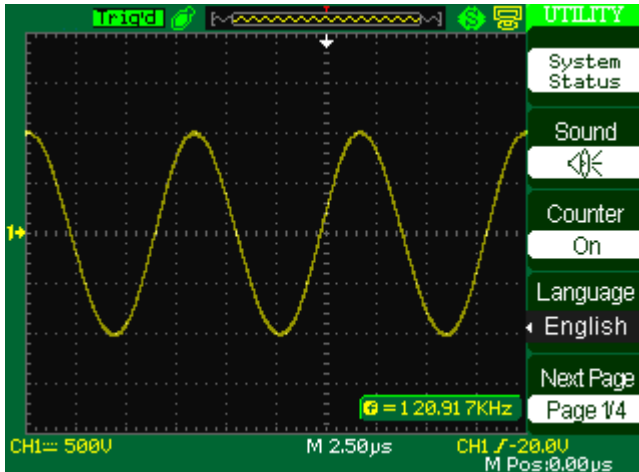

Figure 67 - Utility Menu Screen 1

Table 49 - Utility System Function Menu 2

Option	Setting	Introduction
Do self cal		Auto self emendation.
Do Self Test	Screen Test Keyboard Test LED Test	Run the screen detect program Run the keyboard detect program Run the LED test detect program.
Print Setup		Not available.
Back USB	Printer	Not available.

	Computer	The oscilloscope connects to the computer using USB cable. When you execute EasyScope software, please select “Computer”. Now the computer icon displays on the screen.
Next Page	Page 2/4	Press this button to enter third page.

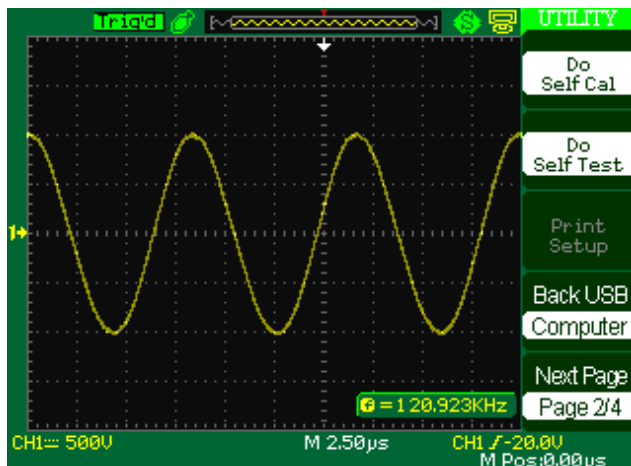

Figure 68 - Utility Menu Screen 2

Table 50 - Utility System Function Menu 3

Option	Setting	Introduction
Update firmware		You can update firmware of the oscilloscope use USB flash Driver (~ two minutes).
Pass/Fail		Pres this button to enter the “Pass/Fail menu”.
Record		Press this button to enter the waveform record menu.
IO Setting		Press this button to enter the “IO Setting menu”
Next Page	Page 3/4	Press this button to enter first page.

Table 51 - IO Setting Function Menu

Option	Setting	Introduction
Baud	300 2400 4800 9600 19200 38400	Set up band rate.

Note: When interfacing with the EasyScope software, it is recommended that users use the rear panel USB interface for communication instead of RS232 because transmission speed is noticeably slower when waveforms are being transferred from scope to PC via RS232 interface port.

Table 52 - Utility System Function Menu 4

Option	Setting	Introduction
Screen-saver	1min 2min 5min 10min 15min 30min 1hour 2hour 5hour Off	Set the time of Screen-saver
Recorder	Record	Goes into record menu to start waveform record.
	Replay	Playback recordings
	Option	Record setups
Return		Returns to previous menu

System Status

Press the “System Status” option button of the Utility Menu to view the oscilloscope’s hardware and software configuration.



Figure 69 - System Status Info Screen

Table 53 - System Status Information

Option	Introduction
Startup Times	List the boot-strap times.
Software version	List the software version.
Hardware Version	List the hardware version.
Product type	List the product type.
Serial No.	List the product serial number.

Language

The oscilloscopes have twelve languages available and selectable for the menu items.

Press the “UTILITY” button, then select “Language”.

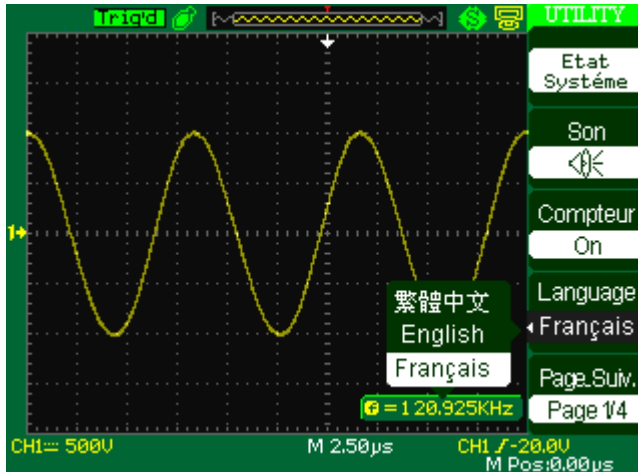

Figure 70 - Language Selection Screen

Self Calibration

Self Calibration procedure can optimize the signal path at the most measurement precision. You can run this procedure at any time. If the operating temperature changes by more than 5° C or the units run more than thirty minutes, you should do the self calibration.

When you run the self Calibration, you should disconnect all the probes and leads, and make sure the scope is not in Single-Shot mode. Then press the “Utility” button to choose the “Do self cal” to show the self Calibration Menu, and execute self calibration program according to the prompt on the screen.

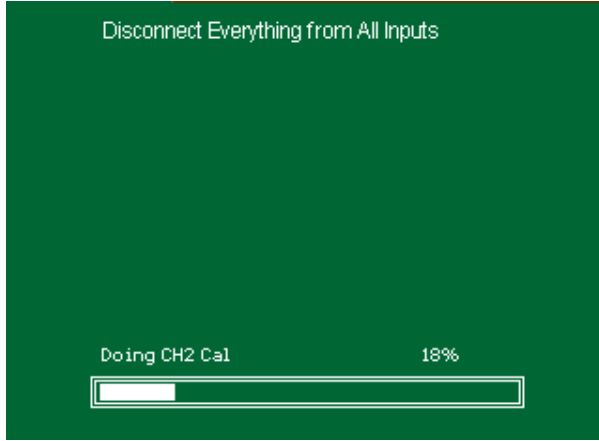

Figure 71 - Calibration Screen

Self Test

Press “UTILITY” and select “Do Self Test”

Table 54 - Self Test Menu

Option	Introduction
Screen Test	Run Screen Test Program.
Keyboard Test	Run Keyboard Test Program.
LED Test	Run LED Test Program.

Screen Test

Select “Screen Test” to enter the screen test interface. The message “Press ‘SINGLE’ Key to continue, Press ‘RUN/STOP’ Key to exit” is displayed.

Press “Single” button for test, “Run/Stop” to exit.



Figure 72- Screen Test Start Screen

Keyboard Test

Select “keyboard Test” to enter the key test interface, the on-screen shapes represent the front panel keys. The shapes with two arrows beside them represent the front panel knobs. The squares represent the knob presses for scale knobs. Test all keys and knobs to verify that all the backlit buttons illuminate correctly.

Note:

- When you operate, the screen would display the white (Color LCD) and black (single LCD) repose.
- The tested button or knobs corresponding area would display green (Color LCD) or white (single LCD).

- At the bottom of the screen display “Press ‘ RUN/STOP’ Key Three Times to exit” information prompt to show that press “RUN/STOP” three times to end test.

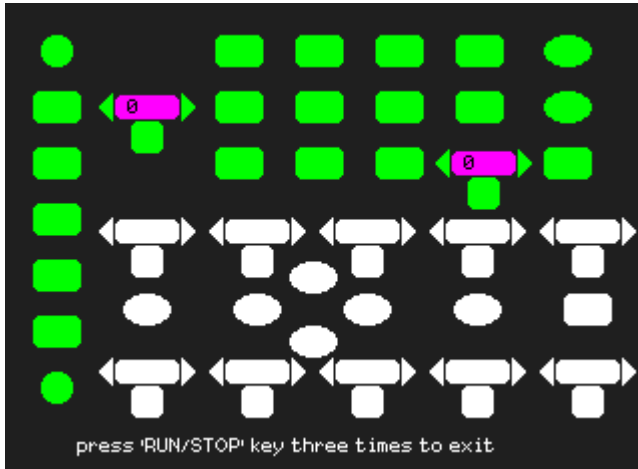

Figure 73 - Key Test Screen

LED Test

Select “LED Test” to enter the lighten interface, the on-screen lathy rectangle shapes represent the front panel keys; the lathy rectangle shapes represent the front panel knobs. The squares represent the knob presses for scale knobs. The clew words “Press ‘SINGLE’ Key to continue , Press ‘RUN/STOP’ Key to exit is displayed, you could press the “Single” button continuously for testing, when buttons are lighted ,the corresponding area on the screen would display green (Color LCD) or white(Single LCD).

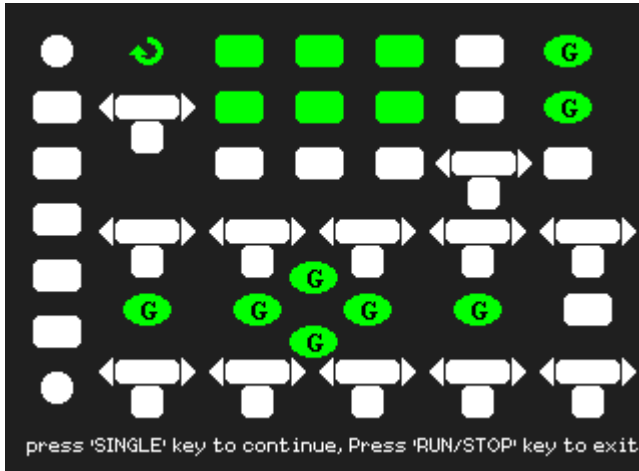

Figure 74 - LED Test Screen

Updating the System Software

- **Using USB flash drive to update firmware**

The software of the oscilloscope can be updated directly via USB Flash drive. This process takes about two minutes. Follow next steps:

1. Insert USB Flash Drive with firmware procedure to USB Host interface on the front panel of the oscilloscope.
2. Press the “UTILITY” button to enter the “Utility menu”.
3. Press “Next Page” option button to enter the third page of “Utility menu”.
4. Press the “Update Firmware” option button.

5. Press the “SINGLE” button to start updating the software according to prompt on the screen.

When completed, turn off the oscilloscope and turn on again. The software will then be updated. The oscilloscope needs to execute “Do Self Cal” after update.

Note: Don’t turn off the power while oscilloscope is updating.

Otherwise, firmware will be corrupted and unit may not be able to boot up.

Pass/Fail

The Pass/Fail function can monitor changes of signals and output pass or fail signals by monitoring the input signal and checking if its within the predefined mask or not.

Table 55 - Pass/Fail Function Menu 1

Option	Setting	Instruction
Enable	On Off	Turn on Pass/Fail function. Turn off Pass/Fail function.
Source	CH1 CH2	Select signal input channel.
Operate	▶	Press to run the Pass/Fail test.
	■	Press to stop the Pass/Fail test.
Msg Display	On Off	Turn on times information display of the waveform pass/fail. Turn off times information display

		of the waveform pass/fail.
Next Page	Page 1/2	Press this button to enter second page of Pass/Fail menu.

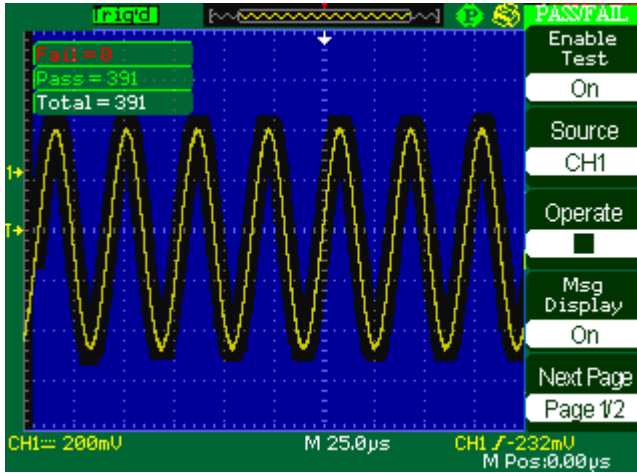

Figure 75 - Pass/Fail Screen 1

Table 56 - Pass/Fail Function Menu 2

Option	Setting	Instruction
Output	Pass Fail	Output when pass condition detected. Output when fail condition detected.
Stop On Output	On Off	Stop test when output occur. Continue test when output occur.
Mask Setting		Press this button to enter the "Mask Setting menu".
Return		Return to the Pass/Fail main menu.
Next Page	Page 2/2	Return the first page of the Pass/Fail menu.

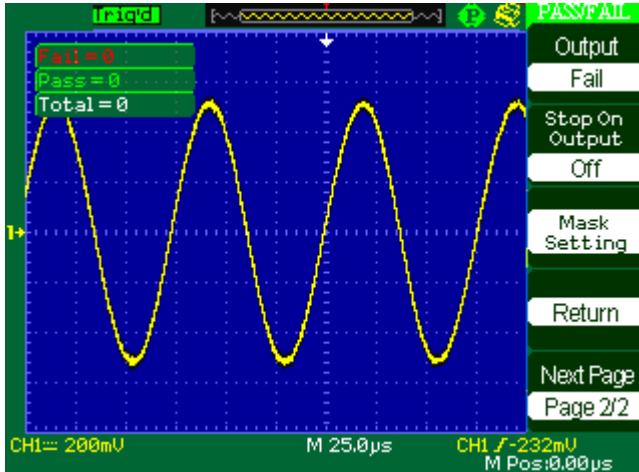

Figure 76 - Pass/Fail Screen 2

Table 57 - Mask Setting Function Menu 1

Option	Setting	Instruction
X Mask ↻ xdiv	/	Turn the “Universal” knob to set the range of horizontal clearance to the waveform. <0.04div-4.00div>
Y Mask ↻ ydiv	/	Turn the “Universal” knob to set the range of vertical clearance to the waveform. <0.04div-4.00div>
Create Mask	/	Create a test mask according to the above clearance.
Location	Internal External	Select position to store created mask.
Next Page	Page 1/2	Press this button to enter the second page of “Mask Setting menu”.

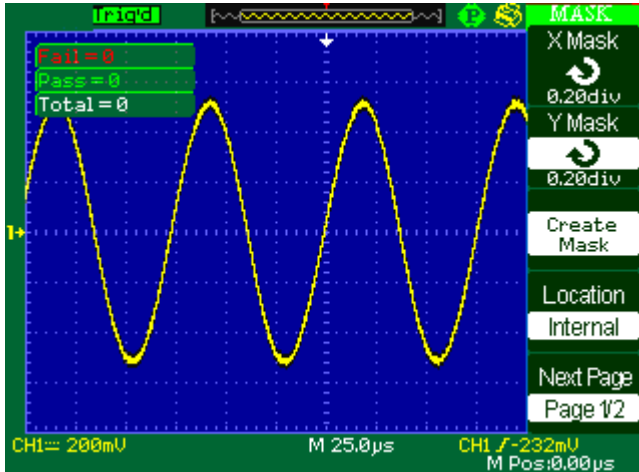

Figure 77 - Mask Menu Screen 1

Table 58 - Mask Setting Function Menu 2

Option	Setting	Instruction
Save		Store created mask setting.
Load		Recall stored mask setting.
Return		Return to the main menu of mask setting.
Last Page	Page 2/2	Return to the first page of the "Mask Setting menu".

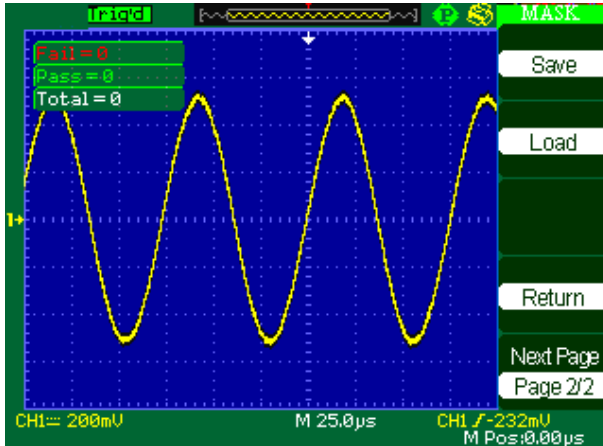

Figure 78 - Mask Menu Screen 2

RUN Pass/Fail test, please follow next page:

1. Press UTILITY button to enter the “Utility menu”.
2. Press the “Next Page Page1/4” option button.
1. Press the “Next Page Page2/4” option button to enter the third page of “Utility menu”.
2. Press the “Pass/Fail” option button to enter the “Pass/Fail” function menu.
3. Press the “Enable Test” option button to select “On”.
4. Press the “Source” option button to select input signal channel.
5. Press the “Next Page Page1/2” option button to enter the second page of the “Pass/Fail menu”.

6. Press the “Mask Setting” option button to enter the first page of “Mask menu”.
7. Press the “X Mask” button; turn the “Universal” knob to adjust the horizontal clearance.
8. Press the “Y Mask” button; turn the “Universal” knob to adjust the vertical clearance.
9. Press the “Create Mask” button to create mask and you also can enter the next page of “Mask menu” to recall the stored mask.
10. Enter the second page of “Pass/Fail function menu”, press the “Output” option button to set the output option.
11. Enter the first page of “Pass/Fail function menu”, press the “Operate” option button to select “▶” to run the pass/fail test.

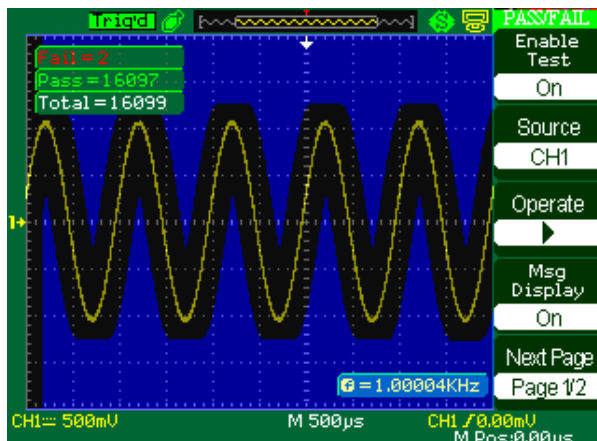



Figure 79 - Masked Pass/Fail Screen

Waveform Recorder

Press the **Record** option to record the input waveform from CH1 and CH2 with a maximum record length of 2500 frames. The time between frames is adjustable. You can record Pass/Fail test output (especially useful when capturing abnormal signals over a long period of time) without having to watch the signal

Table 59 - Waveform Recorder Function Menu

Option	Setting	Instruction
Mode	Record Play Back Storage Off	Set Record function menu. Set Play Back function menu. Set Storage function menu. Turn off waveform recorder menu.
Source	CH1 CH2 P/F-OUT	Select record source channel.
Interval		Set time interval between record frames.
End Frame		Set max number of record frames.
Operate	● (Record) ■ (Stop)	Press to start recording. Press to stop recording.

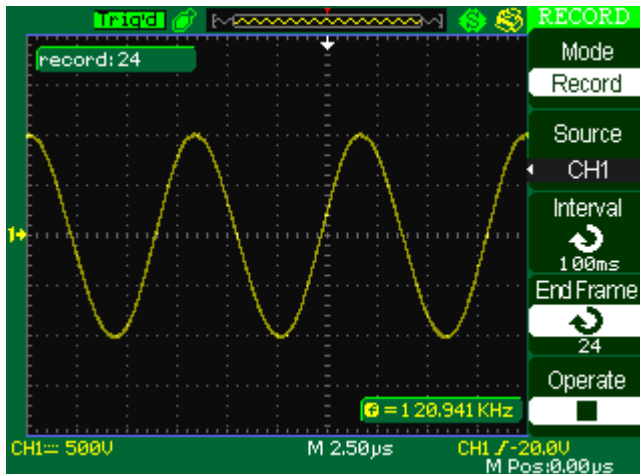

Figure 80 - Record Menu Screen

To record waveforms, follow these steps:

1. Press the UTILITY button to enter “Utility menu”.
2. Press the “Next Page” option button to enter the third page of “Utility menu”.
3. Press the “Record” button to enter “Waveform Record Menu”.
4. Press the “Mode” option button to select “Record”.
5. Press the “Source” option button to select the input signal channel.
6. Select “Interval” option, turn the “Universal” knob to adjust time interval between record frames.
7. Select “End Frame”, select the “Universal” knob to adjust the max record frame.
8. Press “●” in “Operate” option to record waveform.

Play Back: Play back current record waveforms or saved record waveforms.

Table 60 - Waveform Playback Function Menu 1

Option	Setting	Instruction
Mode	Play Back	Set the Play Back function menu.
Operate	▶ (Run) ■ (Stop)	Press to start playback playing. Press to stop playing.
Play Mode	↻ ▶→■	Set circular play mode. Set single time play mode.
Interval	↻	Set time interval between frames.
Next Page	Page 1/2	Enter the second page of Play Back menu.

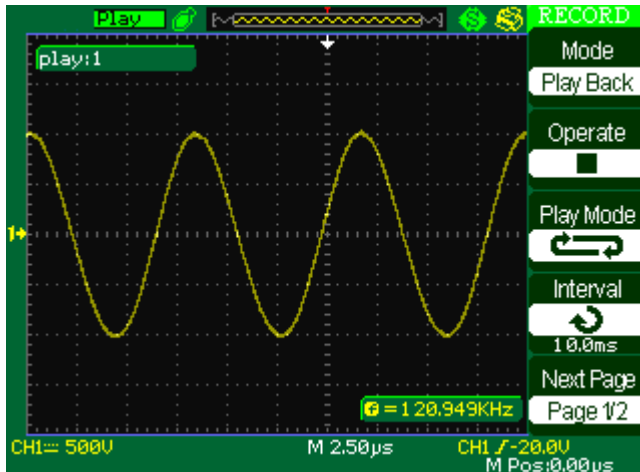





Figure 81 - Record Menu Screen 2

Table 61 - Waveform Playback Function Menu 2

Option	Setting	Instruction
Start Frame		Set start frame.
Curr_Frame		Select current frame to be played.
End Frame		Set End frame.
Return		Press to return the waveform recorder main menu.
Next Page	Page 2/2	Return to the first page of Play Back function menu.

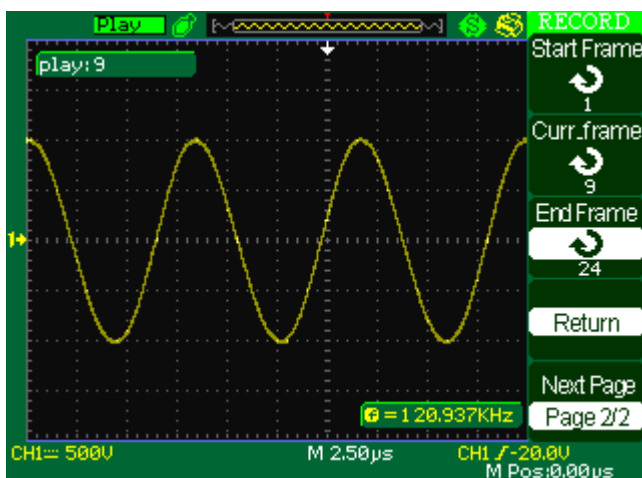



Figure 82 - Record Menu Screen 3

To play back current record waveforms, follow these steps:

1. Press UTILITY button to enter “Utility menu”.
2. Press the “Mode” option button to select “Play Back”.
3. Press the “Play Mode” option button to select “” or “”.
4. Press the “Interval” option button to select time interval between play back frames.

5. Press the “Next Page 1/2” to enter the second page of “Play Back function menu”.
6. Select the “Start Frame” option, turn the “Universal” knob to adjust the start frame of play back waveform.
7. Select the “End Frame” option, turn the “Universal” knob to adjust the end frame of play back waveform.
8. Press the “Next Page 2/2” option button to return the first page of “Play Back menu”.
9. Press the “▶” option button in “Operate” option to play back waveforms.

Record

This mode allows for gap free recording of waveform data and can be enabled in SCAN MODE only (refer to “Horizontal Control Knob section”). It is similar to the above described waveform recorder mode, however the recorded data can only be played back on-screen, but cannot be retrieved. Maximum recordable data depends on the timebase in scan mode. Recorded data can also be stored into external USB flash drive.

Table 62 - Waveform Recording Function Menu

option	Description
Record	Record the waveform persistently
Replay	Replay recorded waveform
Option	Set the recorder properly
Return	Quit the recording function

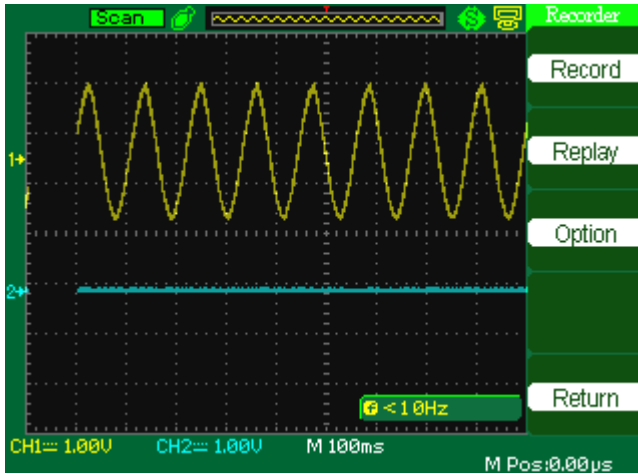

Figure 83 - Record Screen

Table 63 - Waveform Recall Function Menu

Option	Description
Stop	Quit the auto-recalled waveform, then the waveform in EMS memory can be observed through altering the time base, the waveform in EMS memory can be moved left and right
Previous	Recall the waveform again
Next	Fast forward play the recalled waveform again
Return	Quit the recalling interface

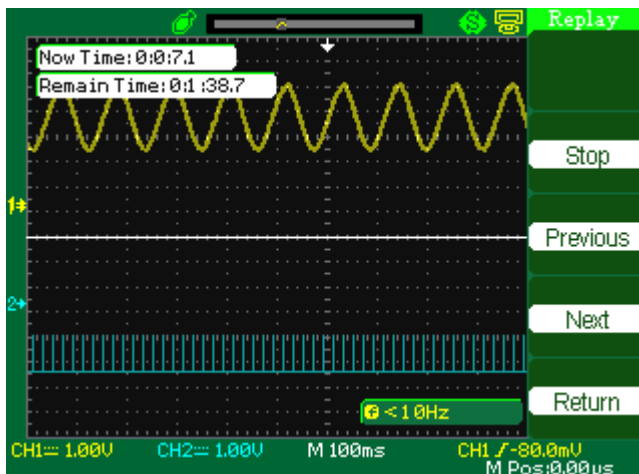

Figure 84 - Replay Screen

Table 64 - Recording Setting Menu

Option	Setting	Description
Viewer	Full Screen	Waveform of Full screen recording and channel recalling
	Split	Waveform of recording on split screen and channel recalling, CH1 is displayed in upper half-screen, CH2 is displayed in lower half-screen.
Record Mode	Roll	Recorder saves the channel waveform persistently, the latter waveform will cover the former.
	Single Sweep	recorder will stop waveform saving when its memory is up to 6M.
Replay Mode	One by One	when recalling, the screen waveform refresh from left to right

	Roll	When recalling, screen waveform will refresh completely according to the capturing time of each frame
Return		quit the recording setting interface

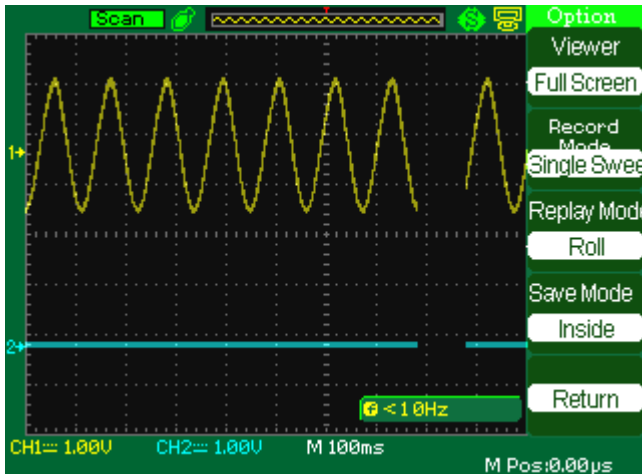

Figure 85 - Option Screen

Recorder Operation step:

1. Press the UTILITY button to enter “Utility menu”.
2. Press the “Next Page” option button to enter the four page of “Utility menu”.
3. Press the “Recorder” button to enter the Recorder manual.
4. Press the “Option” button to select the parameter which you want by yourself
5. Press the “Recorder” button to enter the Record menu and then Press the “Start” button to start record waveform

6. After finished record waveform, then Press the “Replay” button to view the recorded waveform.

Online Help Function

The oscilloscope has an online help function that supplies multi-language help information, and you can recall them to help you operate the oscilloscope when you need.

Press the “HELP” button to enter the help status, then press every button to recall the corresponding help information. Note: If you want to see help information of SINGLE button and RUN/STOP button, you need to see them when you first enter the help status because when you press the SINGLE button you can enter next page of help information and Press the RUN/STOP button you can return to the first page of help information when other button’s help information exceed one page.

All submenus of every main menu have their help information. Note: If you want to see help information of next page submenus, first you need to press the “HELP” button to exit the help status and switch to next page menu then press the “HELP” knob to enter the help status again and press the submenu option buttons to see its help information.

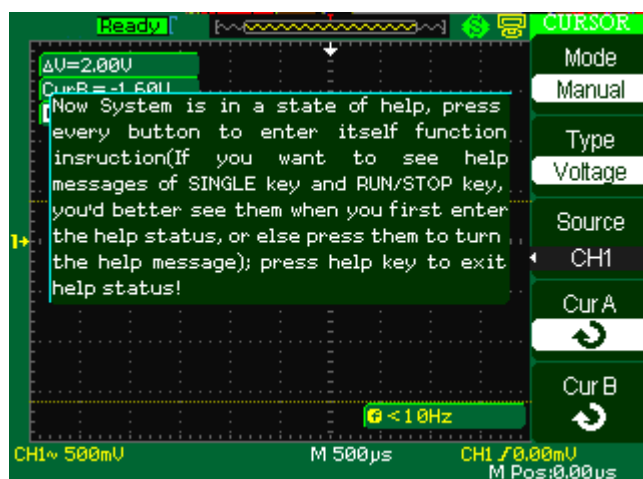

Figure 86 - Help Menu Screen

Chapter 3 Application Examples

This section presents a series of application examples. These simple examples highlight the features of the oscilloscope and give you ideas for using it to solve your own test problems.

- Taking simple measurements
- Taking cursor measurements
- Capturing a single-shot signal
- Analyzing signal detail
- Triggering on a video signal
- Application of X-Y function
- Analyzing a differential communication signal using math functions

Taking Simple Measurements

Observe an unknown signal in a circuit, display the signal quickly and measure the frequency and peak-to-peak amplitude.

1. Using Auto set

To quickly display a signal, follow these steps:

- Press the CH1 button, set the Probe option attenuation to 10X and set the switch to 10X on the probe.
- Connect the channel 1 probe to the signal.
- Press the AUTO button.
- The oscilloscope sets vertical, horizontal, and trigger controls automatically. If you want to optimize the display of the waveform,

You can adjust these controls manually till you are satisfied with the waveforms

NOTE. The oscilloscope displays relevant automatic measurements in the waveform area of the screen based on the signal type detected.

2. Taking Automatic Measurements

The oscilloscope can take automatic measurements of most displayed signals. To measure signal frequency and peak-to-peak amplitude, follow these steps:

Measure signal frequency

- Input the signal to channel 1.
- Press the “AUTO” button.
- Press the “MEASURE” button to see “auto Measure Menu”.
- Press the top option button.
- Press the “Time” option button to enter the “Time Measure menu”.
- Press the “Source” option button to select input signal channel.
- Press the “Type” option button to select “Freq”.

The corresponding icon and measure value will display on the third option area.

Measure signal peak-to-peak amplitude

- Press the “MEASURE” button to display “auto measure menu”.
- Press the top second option button.
- Press the “Voltage” option button to enter the “Voltage measure menu”.
- Press the “Source” option button to select input signal channel.
- Press the “Type” option button to select “Vpp”.

The corresponding icon and measure value will display on the third option area.

Taking Cursor Measurements

You can use the cursors to take time and voltage measurements of a waveform quickly.

Measuring Ring Frequency

To measure the ring frequency at the rising edge of a signal, follow these steps:

3. Press the “CURSORS” button to see the “Cursor Menu”.
4. Press the “Mode” button to select “Manual”.
5. Press the “Type” option button and select “Time”.
6. Press the “Source” option button and select “CH1”.
7. Press the “CurA” button and turn the universal knob to place the cursor A on one peak of the ring.
8. Press the “Cur B” button and turn the universal knob to place the cursor B on the nearest peak of the ring.

You can see the delta time and frequency (the measured ring frequency) on the top left of the screen.

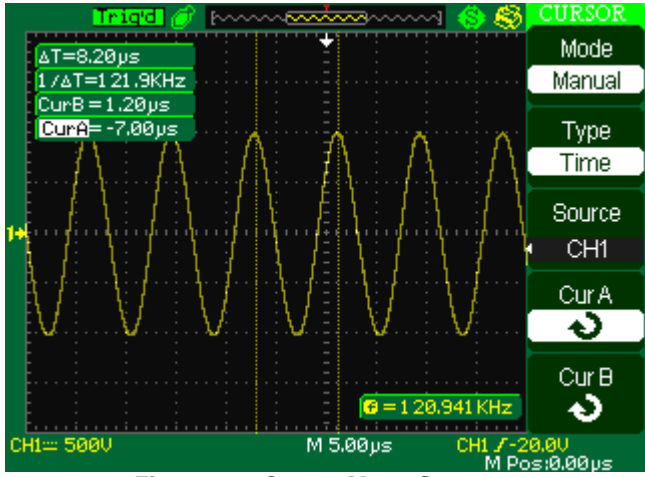

Figure 87 - Cursor Menu Screen 1

Measuring Ring Amplitude

To measure the amplitude, follow these steps:

1. Press the “CURSORS” button to see the Cursor Menu.
2. Press the “Mode” button to select “Manual”.
3. Press the “Type” option button and select “Voltage”.
4. Press the “Source” option button and select “CH1”.
5. Press the “CurA” option button and turn the universal knob to place the cursor A on the highest peak of the ring.
6. Press the “CurB” option button and turn the universal knob to place the cursor B on the lowest peak of the ring.

You can see the following measurements on the top of the left screen:

- The delta voltage (peak-to-peak voltage of the ringing)
- The voltage at Cursor A.
- The voltage at Cursor B.

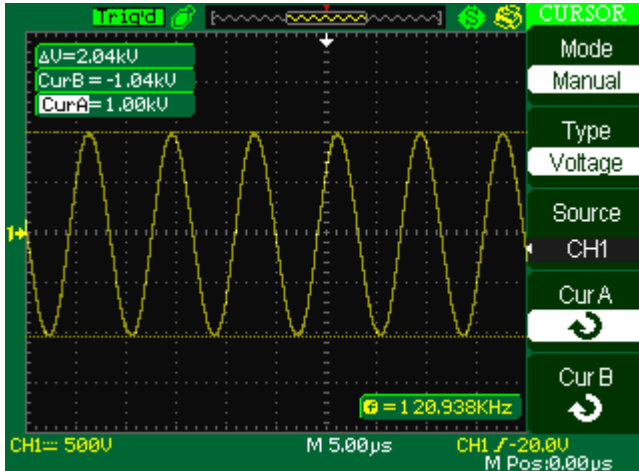

Figure 88 - Cursor Menu Screen 2

Capture a single event

To capture a single event, you need to gather some knowledge of the signal in order to correctly set up the trigger level and slope. If you are not sure about the instance of the signal, you can observe it through auto or normal trigger mode to ensure the trigger level and slope will capture the signal.

The following steps show you how to use the oscilloscope to capture a single event.

1. Set the Probe option attenuation to 10X and set the switch to 10X on the probe.
2. Trigger set up:
 - 1) Press “TRIG MENU” button to show the “Trigger Menu”
 - 2) Under this menu, set the trigger type to “edge”, Edge type is “Rising”, source is “CH1”, trigger mode is “Single”, coupling is “DC”
 - 3) Adjust the horizontal time base and vertical scale to the satisfied range
 - 4) Turn the “LEVEL” knob to adjust the trigger level
 - 5) Press the “RUN/STOP” button to start capturing

When the trigger conditions are satisfied, data appears on the display representing; the data points that the oscilloscope obtained with one acquisition and press the RUN/STOP button again rearms the trigger circuit and erases the display.

Analyzing the Signal Detail

You have a noisy signal displayed on the oscilloscope and you need to know more about it. You suspect that the signal contains much more detail than you can now see in the display.

Looking at a Noisy Signal

The signal appears noisy and you suspect that noise is causing problems in your circuit. To analyze the noise better, follow these steps:

- 1) Press the “ACQUIRE” button to see the acquire menu.
- 2) Press the “Acquisition” option button or turn the “Universal” knob to select “Peak Detect”.
- 3) If necessary, press the “DISPLAY” button to see “Display menu”. Turn the “Universal” knob to adjust waveform intensity and grid brightness to see the noise more clearly.
- 4) Peak detect emphasizes noise spikes and glitches in your signal, especially when the time base is set to a slow setting.

Separating the Signal from Noise

To reduce random noise in the oscilloscope display, follow these steps:

- 1) Press the “ACQUIRE” button to display the acquire menu.
- 2) Press the “Acquisition” option button or turn the “Universal” knob to select “Average”.

- 3) Press the “Averages” option button to see the effects of varying the number of running averages on the waveform display.

Averaging reduces random noise and makes it easier to see the details of a signal.

Triggering on a Video Signal

Observe the video circuit in a piece of medical equipment and use the video trigger to obtain a stable display.

Triggering on Video Field

To trigger on the video fields, follow these steps:

- 1) Press the “TRIGGER MENU” button to see “trigger menu”
- 2) Press the top option button and select “Video”.
- 3) Press the “source” option button and select “CH1”.
- 4) Press the “Sync” option button and select “Odd Field” or “Even Field”.
- 5) Press the “Standard” option button and select “NTSC”.
- 6) Turn the horizontal “Time/Div” knob to see a complete field across the screen.
- 7) Turn the vertical “Volts/Div” knob to ensure that the entire video signal is visible on the screen.

Triggering on Video Lines

To trigger on the video lines, follow these steps:

1. Press the “TRIGGER MENU” button to see the trigger menu.
2. Press the top “option” button and select “Video”
3. Press the “Sync” option button and select “Line Num” and turn the universal knob to set a specific line number.
4. Press the “Standard” option button and select “NTSC”.
5. Turn the “Time/Div” knob to see a complete video line across the screen.
6. Turn the “Volts/Div” knob to ensure that the entire video signal is visible on the screen.

Application of X-Y Function

Viewing Impedance Changes in a Network

Connect the oscilloscope to monitor the input and output of the circuit

To view the input and output of the circuit in an XY display, follow these steps:

1. Press the “CH 1” MENU button and set the Probe option attenuation to 10X.
2. Press the “CH 2” MENU button and set the Probe option attenuation to 10X.
3. Set the switch of the probe to 10X.

4. Connect the channel 1 probe to the input of the network, and connect the channel 2 probe to the output.
5. Press the “AUTO” button.
6. Turn the “Volts/div” knobs to display approximately the same amplitude signals on each channel.
7. Press the “DISPLAY” button.
8. Press the Format option button and select “XY”.
9. The oscilloscope displays a Lissajous pattern representing the input and output characteristics of the circuit.
10. Turn the VOLTS/DIV and VERTICAL POSITION knobs to optimize the display.
11. Press the “Persist” option button and select “Infinite”.
12. Press the “Intensity” or “Brightness” option buttons and turn the “Universal” knob to adjust the contrast of the screen.

Apply the Ellipse method to observe the phase difference between the two channels

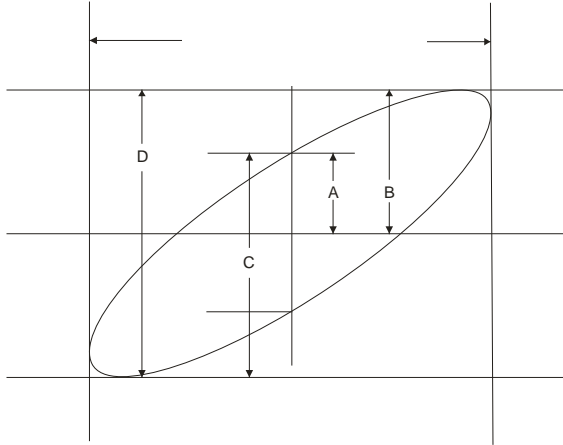

$\sin \theta = A/B$ or C/D where $\theta =$ phase shift (in degrees) between the two signals from the formula above, you could get:

$\theta = \pm \arcsine (A/B)$ or $\pm \arcsine (C/D)$

If the main axis of the ellipse is at II and IV quadrant, θ must be in the range of $(0-\pi/2)$ or $(3\pi/2-2\pi)$. If the main axis is at I and III quadrant, θ must be in the range of $(\pi/2-\pi)$ or $(\pi-3\pi/2)$.

Analyzing a Differential Communication Signal

You are having intermittent problems with a serial data communication link, and you suspect poor signal quality. Set up the oscilloscope to show you a snapshot of the serial data stream so you can verify the signal levels and transition times.

Because this is a differential signal, you use the math function of the oscilloscope to view a better representation of the waveform.

To activate the differential signals connected to channel 1 and channel 2, follow these steps:

1. Press the CH 1 button and set the Probe option attenuation to 10X.
2. Press the CH 2 button and set the Probe option attenuation to 10X.
3. Set the switches to 10X on the probes.
4. Press the AUTO button.
5. Press the “MATH” button to see the Math Menu.
6. Press the “Operation” option button and select “—”.
7. Press the “CH1 — CH2” option button to display a new waveform that is the difference between the displayed waveforms.
8. You can adjust the vertical scale and position of the Math waveform. To do so, follow these steps:
 - a. Remove the channel 1 and channel 2 waveforms from the display.
 - b. Turn the CH 1 and CH 2 VOLTS/DIV and VERTICAL POSITION knobs to adjust the vertical scale and position.

NOTE. First be sure to compensate both probes. Differences in probe compensation appear as errors in the differential signal.

Chapter 4 Message Prompts and Troubleshooting

Message Prompts

- **Trig level at limit!** : Prompts you that the trigger Level is at a limit when you turn the Trig level knob.
- **Horizon position at limit!** : Prompts you that the horizontal position is at a limit when you turn the horizon position knob.
- **Volts/Div at limit!** : Prompts you that the vertical voltage have already touched the Min 2MV/div or the Max 5V/div.
- **Volts position at limit!** : The system would display this information when the vertical position is at a limit.
- **Time/Div at limit!** : Prompts that the Volts/Div is at full range while turning the vertical scale knob.
- **Holdoff time at limit!** : Turn the “Universal” knob when holdoff time has been to max or min value, now the system will clew this information.
- **Function isn’t useable!** : Under several special modes, some functions could not be running.

- **No signal!** : The system would display this information when the signal could not match the auto set condition. (Using in the auto set)
- **Adjust at limit!** : You could adjust the pulse width by the universal knob till the pulse width has reached min 20.0 ns or max 10.0 s.
- **Location Empty!** : If you have no stored waveforms or setups on some location, the screen will display this information when you press the “Recall” button on this location.
- **USB Flash Drive Plug In!** : This information will appear when you insert the USB Flash Drive to the USB Host port.
- **USB Flash Drive Pull Out!** : This information will appear when you pull out the USB Flash Drive.
- **Store Data Success!** : Saving setup data, waveform data or picture data to the internal memory of the oscilloscope or USB flash was successful.
- **Ready Data Success!** : Read setup data or waveform data from the internal of the oscilloscope or USB flash successful.
- **Please set Back USB to printer!**
- **USB Flash Drive isn’t connected!** : When the “Save To” option is set to “File” or the “Print Key” option is set to “Save Picture” in

“Save/Recall” menu , Press the “Save” option button or the “time/div” knob before inverting the USB Flash Drive to the USB Host port or this will appear on the screen.

- **Record Wave Success! :** This message will appear when you finish recording waveforms.

Troubleshooting

1. **After the oscilloscope is powered on, the screen remains dark.**

Please do the following:

1. Check the power cable’s connection.
2. Ensure the power switch is turned on.
3. After the inspections above, restart the oscilloscope.
4. If the oscilloscope is still not useable after checking, please connect B&K Precision.

2. **If there is no signal wave in the screen after probing DUT for a signal, please do as follows:**

1. Check whether the probe is connecting with the signal cable or not.
2. Check whether the signal cable is connected with the BNC connector or not.

3. Check the probe whether it's connected with the device under test (DUT) or not.
 4. Check the tested DUT to see if it produces the signal or not.
 5. Try to probe the DUT for signal again.
- 3. The value of the tested voltage is 10 times higher/lower than the real one , please do the following:**

Check the attenuation quotient whether it matches the probe attenuation proportion or not.

- 4. Display the wave, but not steady , please do as following steps:**
1. Check the signal source on the trigger interface whether or not it matches the signal channel.
 2. Check the trigger mode: normal signal should use the “edge” trigger mode. The video signal should use the “Video” Trigger mode. The signal would display steadily only when using matching trigger mode.
 3. Attempt to change the “coupling” into “HF Reject” or “LF Reject” display, so that the High/low frequency noise will be filtered.
- 5. Press “RUN/STOP” button, but no display.**

Check the trigger mode on the trigger interface whether or not it's in "normal" or "single", and check the trigger level whether or not it is over the wave range. If yes, please put the trigger level to the middle position or set the trigger mode to the "Auto" position. Another way is to choose the "Auto" button to set up automatically.

6. After the Acquisition is set to Averages or Display Persistence time is set too long, the waveform refreshes slowly.

It is normal in these settings.

7. The signal is displayed as a ladder-like waveform

1. This phenomenon is normal. The time base may be too slow. Turn the horizontal SCALE knob to increase horizontal resolution to improve the display.
2. Maybe the display Type is set to "Vectors". You could set it to Dots mode to improve the display.

Chapter 5 Specifications

- All specifications apply to measurements with a 10X probe To verify that the oscilloscope meets specifications, the oscilloscope must first meet the following conditions:
 - The oscilloscope must have been operating continuously for thirty minutes within the specified operating temperature.
 - You must perform the Do Self Cal operation, accessible through the Utility menu, if the operating temperature changes by more than 5° C.
 - The oscilloscope must be within the factory calibration interval
- All specifications are guaranteed unless noted “typical.”

Specifications

Inputs	
Input Coupling	AC, DC, GND
Input Impedance	1 M Ω \pm 2% 16 pf \pm 3 pf
Maximum input voltage	400 V (DC+AC PK-PK, 1 M Ω input impedance, X10), CAT I 5 Vrms; +/-10 V Peak for 1 s pulse, 50 % duty cycle (50 Ω BNC)
Ch to Ch Isolation (Both channels in same V/div	>100:1 at 10 MHz

setting)	
Probe attenuator	1X, 10X
Probe attenuation selectable factors	1X, 10X, 100X, 1000X

Vertical System	
Vertical Sensitivity	2 mV/div – 10 V/div (1-2-5 order)
Channel voltage offset range	2 mV–100 mV: ± 2 V 102 mV – 10 V: ± 40 V
Vertical Resolution	8 bit
Channels	2
Analog Bandwidth	25 MHz
Single-shot Bandwidth	25 MHz
Lower frequency limit (AC - coupled)	≤ 10 Hz (at input BNC)
DC Gain Accuracy	$< \pm 3.0\%$: 10 mV/div to 10 V/div in fixed gain ranges $< \pm 4.0\%$: 2 mV/div , 5 mV/div and variable gain ranges
DC Measurement Accuracy: All Gain settings ≤ 100 mV/div	$\pm [3\%*(reading + offset)+1\%* offset +0.2 \text{ div}+2 \text{ mV}]$
DC Measurement Accuracy: All Gain settings > 100 mV/div	$\pm [3\%*(reading + offset)+ 1\%* \text{ offset}+0.2 \text{ div}+100 \text{ mV}]$
Rise time	< 14 ns
Overshoot, Typical (using 500ps pulse)	$< 10\%$ with probe or BNC input w/ 50 Ohm feed thru
Math operation	+, -, *, /, FFT
FFT	Window mode: Hanning, Hamming, Blackman, Rectangular Sampling points: 1024

Horizontal System	
Real Time Sampling Rate	Single Channel: 500 MSa/s Dual Channel: 250 MSa/s (when timebase is faster than 250 nS/div)
Equivalent Sampling Rate	The highest equivalent sampling rate is 10 GSa/s.
Measure Display Modes	MAIN, WINDOW, WINDOW ZOOM, ROLL, X-Y
Timebase Accuracy	±100ppm measured over 1ms interval
Horizontal Scan Range	25 nS/DIV – 50 S/DIV
	Scan Mode: 100 mS/DIV – 50 S/DIV (1-2.5-5 sequence)
Maximum Memory Length (interleaved)	32,000 points* (16000 points for dual channel operation)

*The number of data points depends on the timebase setting and whether or not the oscilloscope is in single or dual channel mode. More details on how many datapoints can be saved to a CSV file can be found in the storage chapter of this manual. The number of datapoints that can be captured via USB device interface using the EasyScope software is specified in the EasyScope manual.

Trigger System	
Trigger Types	Edge, Pulse Width, Video, Slope, Alternative
Trigger Source	CH1,CH2, ,EXT,EXT/5, AC Line
Trigger Modes	Auto, Normal, Single
Trigger Coupling	AC, DC, LF reject, HF reject
Trigger Level Range	CH1,CH2,: ± 6 divisions from center of screen
	EXT: ±1.2 V
	EXT/5: ±6 V
Trigger Level Accuracy (typical) applicable for the signal of rising and falling time ≥20ns	Internal: ±(0.2 div×V/div) (within ± 4 divisions from center of screen) EXT: ±(6% of setting + 40 mV) EXT/5: ±(6% of setting + 200 mV)
Trigger Sensitivity	For fixed gain ranges

	1 Divisions: DC-10 MHz 1.5 Divisions: 10 MHz - 25 MHz
	EXT: 200 mVpp DC-10 MHz, 300 mVpp 10 MHz - 25 MHz
	EXT/5: 1 Vpp DC-10 MHz, 1.5 Vpp 10 MHz - 25 MHz
Pulse Width Trigger	Trigger Modes: (>, <, =) positive Pulse Width, (>, <, =) Negative Pulse Width Pulse width range: 20 ns – 10 s
Video Trigger	Support signal formats: PAL/SECAM, NTSC Trigger condition : odd field, even field, all lines, line Num
Slope Trigger	(>, <, =) Positive slope, (>, <, =) Negative slope Time: 20 ns-10 s
Alternative Trigger	CH1 trigger type: Edge, Pulse, Video, Slope CH2 trigger type: Edge, Pulse, Video, Slope

Display System	
Display Mode	Color TFT 5.7 in(145 mm) diagonal Liquid Crystal Display
Resolution	320 horizontal by 240 vertical pixels
Display Color	64K color
Display Contrast (Typical state)	150:1
Backlight Intensity (Typical state)	300 cd/m ²
Wave display range	8 x 12 div
Wave Display Mode	Dots, Vector
Persist	Off, 1 sec, 2 sec, 5 sec, Infinite
Menu Display	2 sec, 5 sec, 10 sec, 20 sec, Infinite
Screen-Saver	Off, 1 min, 2 min, 5 min, 10 min, 15 min, 30 min, 1 hour, 2 hour, 5 hour

Skin	Classical, Modern, Tradition, Succinct
Waveform interpolation	Sin(x)/x, Linear
Color model	Normal , Invert
Language	Simplified Chinese, Traditional Chinese, English, Arabic, French, German, Russian, Spanish, Portuguese, Japanese, Korean, Italian

X-Y Mode	
X-pole Input / Y-Pole Input	Channel 1 (CH1) / Channel 2 (CH2)
Phase Error	± 3 degrees

Hardware Frequency Counter	
Reading resolution	6 Bytes
Accuracy	±0.01%
Range	DC Couple, 10 Hz to 25 MHz
Signal Types	Satisfying all trigger signals (except pulse width trigger and video trigger)

Environment Condition	
Temperature	Operating: 50° F to 104 °F (10 °C to +40 °C) Not operating: -4 °F to 140 °F (-20 °C to +60 °C)
Cooling	Internal cooling fan
Humidity	Operating: 85% RH, 104 °F (40 °C), 24 hours Not operating: 85% RH, 149 °F (65 °C), 24 hours
Elevation	Operating: 9,842.5 ft (3,000m) Nonoperating: 50,085.3 ft (15,266m)

Control Panel Function

Auto Set	Auto adjusting the Vertical, Horizontal system and Trigger Position
Save/Recall	save/recall 2 referenced waveforms, 20 setups, and 10 captured waveforms to/from internal memory or to external USB flash drive.

Power Supply	
Input Voltage	100-240 VAC, CAT II, Auto selection
Frequency Range	45Hz to 440Hz
Power	50VA Max

Mechanical	
Dimensions (WxDxH)	12 x 6.3 x 5.2 inches (305 x 160 x 133 mm)
Weight	About 5 lbs (2.3 kg)

Interface	
USB	USB Device Port: For Flash Drives USB Host Port: For PC interface with EasyScope software

Specifications are subject to change without notice.
 To ensure the most current version of this manual, please download the current version here: <http://www.bkprecision.com/search/manual/2530B>
 For current up-to-date product information, please visit www.bkprecision.com

Certification

CE Compliant

CE Declaration of Conformity

The oscilloscope meets the requirements of 2006/95/EC Low Voltage Directive and 2004/108/EC Electromagnet Compatibility Directive.

Low Voltage Directive

- EN61010-1: 2001
Safety requirements for electrical equipment for measurement, control, and laboratory use.

The oscilloscope meets the following:

- Installation Categories II (Supply Connector) and I (Measuring Terminals).
- Pollution Degree 2 (Normally only dry non-conductive pollution occurs. Occasionally a temporary conductivity caused by condensation must be expected.)
- Protection Class I (Provided with terminal for protective ground).
- EN 61010-031: 2002+A1: 2008
Safety requirements for hand-held probe assemblies for electrical measurement and test.

EMC Directive

- EN 61000-3-2: 2006
- EN 61000-3-3: 1995+A1: 2001+A2: 2005
- EN 61326-1: 2006
Electrical equipment for measurement, control, and laboratory use.

Appendix A Default Setup

Menu or system	Options, knobs or buttons	Default setup
CH1,CH2	Coupling	DC
	Volts/div	Coarse
	Probe	1X
	Invert	Off
	Filter	Off
	Volts/div	1.00V
MATH	Operation	CH1+CH2
	CH1 Invert	Off
	CH2 Invert	Off
	FFT operation:	
	Source	CH1
	Window	Hanning
	FFT Zoom	1X
	Scale	dBVrms
	Display	Split
HORIZONTAL	Window	Main
	Position	0.00 μ s
	Time/div	500 μ s
	Window Zone	50.0 μ s
	Trigger knob	level
CURSOR	Type	Off
	Source	CH1
	Horizontal (voltage)	+/- 3.2divs

	Vertical (time)	+/- 5divs
MEASURE	Source	CH1
	Type	average
ACQUIRE	three mode options	Sampling
	Averages	16
	Sampling mode	Real Time
DISPLAY	Type	Vectors
	Persist	off
	Gird	
	Intensity	60%
	Brightness	40%
	Format	YT
	Menu Display	infinite
SAVE/RECALL	Type	Setups
	Save To	Device
	Setup	No.1
REF UTILITY	REFA/REFB	REFA
	Source	CH1
	REFA	off
	REFB	off
	Sound	On
	Counter	On
	Back USB	Computer
	Pass/Fail	off
	Record	off
	RS-232 Baud	9600
TRIGGER (edge)	Type	edge
	Source	CH1

	Slope	Rising
	Mode	Auto
	Coupling	DC
	LEVEL	0.00V
TRIGGER (pulse)	Type	pulse
	Source	CH1
	When	=
	Set Pulse Width	1.00ms
	Mode	Auto
	Coupling	DC
TRIGGER (Video)	Type	Video
	Source	CH1
	Polarity	Normal
	Sync	All Lines
	Standard	NTSC
	Mode	Auto
TRIGGER (Slope)	Type	Slope
	Source	CH1
	Time	1.00ms
	Mode	Auto
TRIGGER (Alternative)	Type	Alternative
	Source	CH1
	Mode	Edge
	Coupling	DC

Appendix B Index

- Width, 109
- + Width, 109
- Alternative Trigger**, 74
- Auto set, 27
- Blackman, 48
- Counter, 131
- Coupling, 32
- Creating Folders and Files, 116
- DEFAULT SETUP**, 29
- Digital Filter**, 40
- EXT TRIG**, 26
- Fall, 109
- FFT, 44
- Filter, 33
- Hanning, 48
- Help, 160
- Keyboard Test, 143
- Language, 131
- Math Functions, 42
- Pass/Fail, 146
- Peak Detect**, 84
- Persist, 91
- Polarity, 67
- Probe Attenuation, 20
- Probe Compensation, 20
- Pulse Trigger**, 64
- Recalling Files, 115
- REF, 53
- Rise, 109
- S/div**, 56
- Sampling**, 84
- Save Picture**, 126
- Screen Test, 143
- Self Calibration, 141
- Self Test, 142
- SET TO 50%**, 24
- Sinx/x, 83
- Slope Trigger**, 70
- Storage, 113
- Sync, 67
- System Status, 134
- Time Domain Aliasing**, 87
- Track Mode, 101
- Trigger, 58
- Trigger status, 15
- Universal Knob, 30
- Updating, 145
- Utility, 131
- Video Trigger**, 67
- Vmax, 108
- Vmin, 108
- Volts/Div**, 37
- Vpp, 108
- Waveform Recorder, 152
- Window, 45
- Window Zone, 57
- X-Y Format, 96

Appendix C Disabling Auto Function

The 2530B has the ability to disable the Auto button that would automatically setup the scope to display a signal, circumventing the need to know how to set up scope parameters. This feature could be used by educators as a teaching tool for basic oscilloscope operation.

To receive information on how to disable this Auto button function, please contact B&K Precision at http://www.bkprecision.com/contact_us.

SERVICE INFORMATION

Warranty Service: Please go the support and service section on our website www.bkprecision.com to obtain a RMA #. Return the product in the original packaging with proof of purchase to the address below. Clearly state on the RMA the performance problem and return any leads, probes, connectors and accessories that you are using with the device.

Non-Warranty Service: Please go the support and service section on our website www.bkprecision.com to obtain a RMA #. Return the product in the original packaging to the address below. Clearly state on the RMA the performance problem and return any leads, probes, connectors and accessories that you are using with the device. Customers not on an open account must include payment in the form of a money order or credit card. For the most current repair charges please refer to the service and support section on our website.

Return all merchandise to B&K Precision Corp. with pre-paid shipping. The flat-rate repair charge for Non-Warranty Service does not include return shipping. Return shipping to locations in North America is included for Warranty Service. For overnight shipments and non-North American shipping fees please contact B&K Precision Corp.

B&K Precision Corp.
22820 Savi Ranch Parkway
Yorba Linda, CA 92887
www.bkprecision.com
714-921-9095

Include with the returned instrument your complete return shipping address, contact name, phone number and description of problem.

LIMITED ONE-YEAR WARRANTY

B&K Precision Corp. warrants to the original purchaser that its products and the component parts thereof, will be free from defects in workmanship and materials for a period of one year from date of purchase.

B&K Precision Corp. will, without charge, repair or replace, at its option, defective product or component parts. Returned product must be accompanied by proof of the purchase date in the form of a sales receipt.

To obtain warranty coverage in the U.S.A., this product must be registered by completing a warranty registration form on our website www.bkprecision.com within fifteen (15) days of purchase.

Exclusions: This warranty does not apply in the event of misuse or abuse of the product or as a result of unauthorized alterations or repairs. The warranty is void if the serial number is altered, defaced or removed.

B&K Precision Corp. shall not be liable for any consequential damages, including without limitation damages resulting from loss of use. Some states do not allow limitations of incidental or consequential damages. So the above limitation or exclusion may not apply to you.

This warranty gives you specific rights and you may have other rights, which vary from state-to-state.

B&K Precision Corp.
22820 Savi Ranch Parkway
Yorba Linda, CA 92887
www.bkprecision.com
714-921-9095

BK PRECISION[®]

22820 Savi Ranch Parkway
Yorba Linda, CA 92887
www.bkprecision.com

© 2010 B&K Precision Corp.