

User Manual

BA8100 - EIS Battery Analyzer



Safety Summary

The following safety precautions apply to both operating and maintenance personnel and must be followed during all phases of operation, service, and repair of this instrument.

WARNING

Before applying power to this instrument:

- Read and understand the safety and operational information in this manual.
- Apply all the listed safety precautions.
- Verify that the voltage selector at the line power cord input is set to the correct line voltage. Operating the instrument at an incorrect line voltage will void the warranty.
- Make all connections to the instrument before applying power.
- Do not operate the instrument in ways not specified by this manual or by B&K Precision.

Failure to comply with these precautions or with warnings elsewhere in this manual violates the safety standards of design, manufacture, and intended use of the instrument. B&K Precision assumes no liability for a customer's failure to comply with these requirements.

Category rating

The IEC 61010 standard defines safety category ratings that specify the amount of electrical energy available and the voltage impulses that may occur on electrical conductors associated with these category ratings. The category rating is a Roman numeral of I, II, III, or IV. This rating is also accompanied by a maximum voltage of the circuit to be tested, which defines the voltage impulses expected and required insulation clearances. These categories are:

Category I (CAT I): Measurement instruments whose measurement inputs are not intended to be connected to the mains supply. The voltages in the environment are typically derived from a limited-energy transformer or a battery.

Category II (CAT II): Measurement instruments whose measurement inputs are meant to be connected to the mains supply at a standard wall outlet or similar sources. Example measurement environments are portable tools and household appliances.

Category III (CAT III): Measurement instruments whose measurement inputs are meant to be connected to the mains installation of a building. Examples are measurements inside a building's circuit breaker panel or the wiring of permanently-installed motors.

Category IV (CAT IV): Measurement instruments whose measurement inputs are meant to be connected to the primary power entering a building or other outdoor wiring.

WARNING

Do not use this instrument in an electrical environment with a higher category rating than what is specified in this manual for this instrument.

! WARNING

You must ensure that each accessory you use with this instrument has a category rating equal to or higher than the instrument's category rating to maintain the instrument's category rating. Failure to do so will lower the category rating of the measuring system.

Electrical Power

This instrument is intended to be powered from a CATEGORY II mains power environment. The mains power should be 115 V RMS or 230 V RMS. Use only the power cord supplied with the instrument and ensure it is appropriate for your country of use.

Ground the Instrument

! WARNING

To minimize shock hazard, the instrument chassis and cabinet must be connected to an electrical safety ground. This instrument is grounded through the ground conductor of the supplied, three-conductor AC line power cable. The power cable must be plugged into an approved three-conductor electrical outlet. The power jack and mating plug of the power cable meet IEC safety standards.

! WARNING

Do not alter or defeat the ground connection. Without the safety ground connection, all accessible conductive parts (including control knobs) may provide an electric shock. Failure to use a properly-grounded approved outlet and the recommended three-conductor AC line power cable may result in injury or death.

! WARNING

Unless otherwise stated, a ground connection on the instrument's front or rear panel is for a reference of potential only and is not to be used as a safety ground. Do not operate in an explosive or flammable atmosphere.

! WARNING

Do not operate the instrument in the presence of flammable gases or vapors, fumes, or finely-divided particulates.

! WARNING

The instrument is designed to be used in office-type indoor environments. Do not operate the instrument

- In the presence of noxious, corrosive, or flammable fumes, gases, vapors, chemicals, or finely-divided particulates.
- In relative humidity conditions outside the instrument's specifications.
- In environments where there is a danger of any liquid being spilled on the instrument or where any liquid can condense on the instrument.
- In air temperatures exceeding the specified operating temperatures.
- In atmospheric pressures outside the specified altitude limits or where the surrounding gas is not air.

- In environments with restricted cooling air flow, even if the air temperatures are within specifications.
- In direct sunlight.

This instrument is intended to be used in an indoor pollution degree 2 environment. The operating temperature range is 0°C to 40°C and 20% to 80% relative humidity, with no condensation allowed. Measurements made by this instrument may be outside specifications if the instrument is used in non-office-type environments. Such environments may include rapid temperature or humidity changes, sunlight, vibration and/or mechanical shocks, acoustic noise, electrical noise, strong electric fields, or strong magnetic fields.

Do not operate instrument if damaged

WARNING

If the instrument is damaged, appears to be damaged, or if any liquid, chemical, or other material gets on or inside the instrument, remove the instrument's power cord, remove the instrument from service, label it as not to be operated, and return the instrument to B&K Precision for repair. Notify B&K Precision of the nature of any contamination of the instrument.

Clean the instrument only as instructed

WARNING

Do not clean the instrument, its switches, or its terminals with contact cleaners, abrasives, lubricants, solvents, acids/bases, or other such chemicals. Clean the instrument only with a clean dry lint-free cloth or as instructed in this manual. Not for critical applications

WARNING

This instrument is not authorized for use in contact with the human body or for use as a component in a life-support device or system.

Do not touch live circuits

WARNING

Instrument covers must not be removed by operating personnel. Component replacement and internal adjustments must be made by qualified service-trained maintenance personnel who are aware of the hazards involved when the instrument's covers and shields are removed. Under certain conditions, even with the power cord removed, dangerous voltages may exist when the covers are removed. To avoid injuries, always disconnect the power cord from the instrument, disconnect all other connections (for example, test leads, computer interface cables, etc.), discharge all circuits, and verify there are no hazardous voltages present on any conductors by measurements with a properly-operating voltage-sensing device before touching any internal parts. Verify the voltage-sensing device is working properly before and after making the measurements by testing with known-operating voltage sources and test for both DC and AC voltages. Do not attempt any service or adjustment unless another person capable of rendering first aid and resuscitation is present.

Do not insert any object into an instrument's ventilation openings or other openings.

WARNING

Hazardous voltages may be present in unexpected locations in circuitry being tested when a fault condition in the circuit exists.

WARNING

Fuse replacement must be done by qualified service-trained maintenance personnel who are aware of the instrument's fuse requirements and safe replacement procedures. Disconnect the instrument from the power line before replacing fuses. Replace fuses only with new fuses of the fuse types, voltage ratings, and current ratings specified in this manual or on the back of the instrument. Failure to do so may damage the instrument, lead to a safety hazard, or cause a fire. Failure to use the specified fuses will void the warranty.

Servicing

WARNING

Do not substitute parts that are not approved by B&K Precision or modify this instrument. Return the instrument to B&K Precision for service and repair to ensure that safety and performance features are maintained.

For continued safe use of the instrument

- Do not place heavy objects on the instrument.
- Do not obstruct cooling air flow to the instrument.
- Do not place a hot soldering iron on the instrument.
- Do not pull the instrument with the power cord, connected probe, or connected test lead.
- Do not move the instrument when a probe is connected to a circuit being tested.

Compliance Statements

Disposal of Old Electrical & Electronic Equipment (Applicable in the European Union and other European countries with separate collection systems)

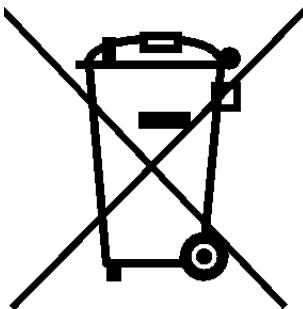

This product is subject to Directive 2002/96/EC of the European Parliament and the Council of the European Union on waste electrical and electronic equipment (WEEE), and in jurisdictions adopting that Directive, is marked as being put on the market after August 13, 2005, and should not be disposed of as unsorted municipal waste. Please utilize your local WEEE collection facilities in the disposition of this product and otherwise observe all applicable requirements.



Safety Symbols











Symbol	Description
	Indicates a hazardous situation which, if not avoided, will result in death or serious injury.
	Indicates a hazardous situation which, if not avoided, could result in death or serious injury
	Indicates a hazardous situation which, if not avoided, will result in minor or moderate injury
	Refer to the text near the symbol.
	Electric Shock hazard
	Alternating current (AC)
	Chassis ground
	Earth ground
	Indicates the In position of the power switch when instrument is ON.
	Indicates the Out position of the power switch when instrument is OFF.
	Indicates practices not related to physical injury.

Table 1 Safety Symbols

Contents

1	General Information	9
1.1	Features	9
1.2	Contents	10
1.3	Dimensions	10
1.4	Front Panel Overview	11
1.5	Display	12
1.6	Rear Panel Overview	13
2	Getting Started	14
2.1	Input Power and Fuse Requirements	14
2.2	Fuse Requirements	15
2.3	Fuse Replacement	15
2.4	Theory of Operation	16
2.5	Connections	16
2.6	Input	16
2.7	Sense	16
3	Measurement Modes	17
4	Measurement Setup	18
4.1	Setting DC Current Level	18
4.2	Setting AC Current Level	18
4.3	Setting Frequency and Sweep	19
4.3.1	Single Frequency	19
4.3.2	Sweep Mode	19
4.4	Making a Measurement	20
5	Verification Test	21
5.1	Verification Procedure	22
5.2	Verification Procedure to the Front Panel	23
5.2.1	Verification Setup	23
5.3	Compensating to the Test Leads	24
5.3.1	Setup	24
5.4	User Calibration	25
5.4.1	User Calibration to the Test Leads	25
5.4.2	User Calibration to the Front Panel	26
6	Operating Software	28
6.1	Software Installation	28
6.2	Interface Configuration	28
6.3	Control Panel	29
6.3.1	Frequency/Amplitude	29
6.3.2	Sweep	30
6.3.3	Analysis	31
6.3.4	Sample	33
6.3.5	Output Condition	33
6.4	Running the Test	33
6.5	Test Results	34
6.6	Data Logging	35

7	System Setup	36
7.1	Menu	36
7.1.1	Input Settings	36
7.1.2	Display Settings	36
7.1.3	I/O Configuration	37
7.1.4	Protection	37
7.1.5	System Setup	37
8	Remote Interface	38
8.1	USBVCP	38
8.2	RS-232	38
8.3	Ethernet	38
8.4	Local and Remote Mode	38
9	Service Information	39
10	LIMITED THREE-YEAR WARRANTY	40

General Information



The BA8100 provides insight on a battery's electrochemical and electrical properties. Using a sweep method called Electrochemical Impedance Spectroscopy (EIS) the unit plots the battery's response at each frequency. The data can be generated as a Nyquist, Bode, or V/I plot. The BA8100 is capable of measuring the parameters listed in chapter 3 of individual cells or strings not exceeding 80 V. These functions make the BA8100 ideal for troubleshooting, maintaining, and conducting performance test on batteries.

1.1 Features

- Fixed frequency measurements from the front panel
- Swept stimulus frequency with included software
- Maximum input voltage of 80 V
- EIS frequency range of 50 mHz to 10 kHz
- Programmable DC and AC current settings
- Measurements include impedance Z, phase angle , voltage and current
- Simple 4-wire test connection
- LAN, USB (COM), and RS232 interfaces standard

1.2 Contents

The following items are included in the box:

- BA8100 Battery Analyzer
- Kelvin connection test leads
- Power Cord
- Self-Test Fixture(TLC81)
- Certificate of Calibration

Note:

Ensure the presence of the items. Contact the distributor or B&K Precision if anything is missing.

1.3 Dimensions

Dimension (L x W x H) 16.14 " x 10.23" x 4.40" (410 x 260 x 112 mm)

Weight 9.9 lbs (4.5 kg)

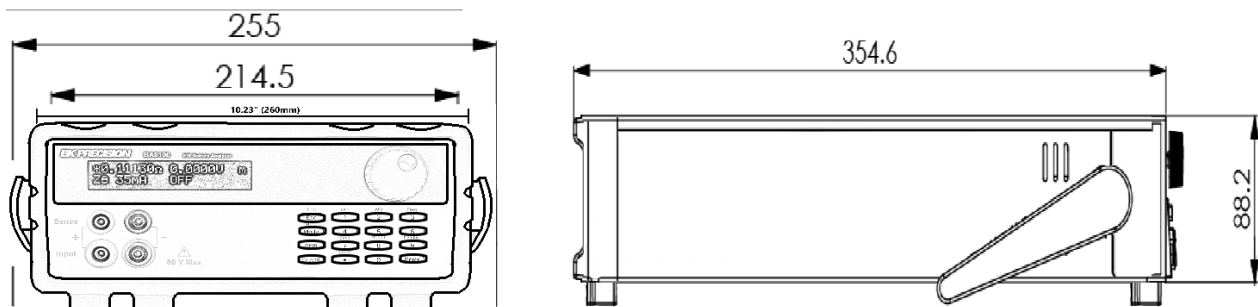

Figure 1.1 Dimensions

1.4 Front Panel Overview

The front panel interface allows for control of the unit.



Figure 1.2 Front Panel

Item	Name	Description
1	Display	Visual presentation of the device function and measurements.
2	Input and Sense Connections	Connection terminals for the provided Kelvin connection test leads.
3	Control Keys	Includes Esc, Mode/Menu, Shift and On/Off keys.
4	Rotary Knob	Used to navigate menus, modes, and adjust parameters.
5	Numeric Keypad	Provides a fast and precise input.

Table 1.1 Front Panel

1.5 Display



Figure 1.3 Display

Item	Name	Description
1	Primary Measurement	Displays the primary measurement value. See section 3 for more details.
2	Secondary Measurement	Displays the secondary measurement value. See section 3 for more details.
3	Measurement Mode	Displays the select measurement mode.
4	Primary Measurement Indicator	Displays the selected primary mode.
5	Current Measurement	Displays the load current.
6	Measurement State/Frequency	Displays the frequency.

Table 1.2 Front Panel

1.6 Rear Panel Overview



Figure 1.4 Rear Panel Overview

Item	Name	Description
1	Power Switch	Powers the unit ON or OFF.
2	AC Power Input & Fuse Box	Houses the fuse as well as the AC input.
3	RS232	Connect a straight RS 232 cable to remotely control the unit.
4	LAN	Connect an ethernet cable to remotely control the instrument.
5	USB Interface	Connect a USB type B to type A to remotely control the unit.

Table 1.3 Rear Panel

Getting Started

2.1 Input Power and Fuse Requirements

The supply has a universal AC input that accepts line voltage input within:

Voltage: **100 - 240 VAC (+/- 10 %)**

Frequency: **50/60 Hz**

Input Power: **60 VA MAX.**



Before connecting to an AC outlet or external power source, be sure that the power switch is in the **OFF** position. Verify that the AC power cord, including the extension line, is compatible with the rated voltage/current. Once verified, connect the cable firmly.

WARNING

The included AC power cord is safety certified for this instrument operating in rated range. To change a cable or add an extension cable, be sure that it can meet the required power ratings for this instrument. Any misuse with an uncertified AC power cord will void the warranty.



SHOCK HAZARD:

The power cord provides a chassis ground through a third conductor. Verify that your power outlet is of the three-conductor type with the correct pin connected to earth ground.

2.2 Fuse Requirements

An AC input fuse is necessary when powering the instrument. The table below shows the fuse required.

Fuse Specification
T3AL, 250 V

A second fuse can be found within the fuse box.

2.3 Fuse Replacement



WARNING

For safety, no power should be applied to the instrument while changing line voltage operation. Disconnect all cables connected to the instrument before proceeding.

Check and/or Change Fuse

- Locate the fuse box next to the AC input connector in the rear panel (see Figure 2)
- With a small flat blade screwdriver, insert into the fuse box slit to pull and slide out the fuse box as indicated below.
- Check and replace fuse if necessary (see Table 2.1 - Fuse Table).

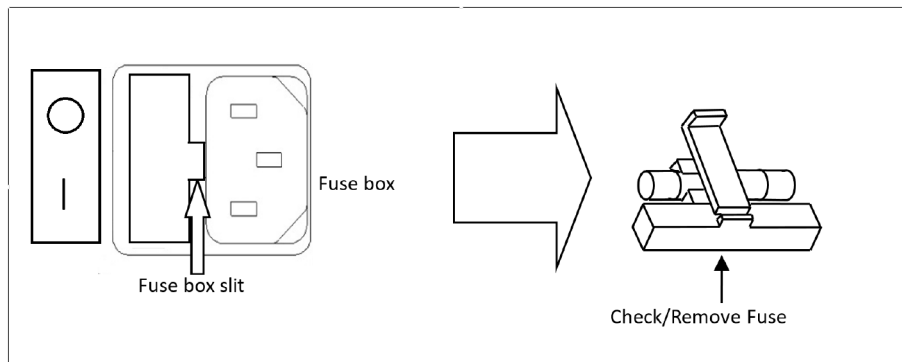

Figure 2.1 Fuse Removal



WARNING

Disconnect power from the instrument when removing and installing fuses.

Any disassembling of the case or changing the fuse not performed by an authorized service technician will void the warranty of the instrument.

2.4 Theory of Operation

The BA8100 stimulates the DUT using a small amplitude and a precisely timed alternating current signal. The unit compares the reference signal and the response signal. By measuring the current and voltage signal at various frequencies, a spectrum of internal impedance is derived.

2.5 Connections



Figure 2.2 Front Panel

The unit uses 4 connections: "Input" (positive and negative) and "Sense" (positive and negative). The provided Kelvin test leads are color coordinated to simplify connections.

2.6 Input

The "Input" connection carries the test current. "Input" consist of the lower pair of connectors, which can be differentiated by grey highlighting rings. The grey rings indicate the banana plugs with a gray shroud are connected there.

2.7 Sense

"Sense" consist of the upper pair connectors. It senses the signal at the connecting point. They do not carry current, which helps eliminate the influence of the cables on the measurement values.

Measurement Modes

The BA8100 contains two measurement modes: primary mode and secondary mode. To enter primary and secondary mode press the **Shift** button then press the **Display** **9** button. The letter m can be seen in to top right side of the screen. The m specifies the current mode state. If blinking "M" is displayed the instrument is in secondary mode. If the blinking "m" is displayed, then the instrument is in primary mode. In **Figure 5.1** we can see the unit is in primary mode

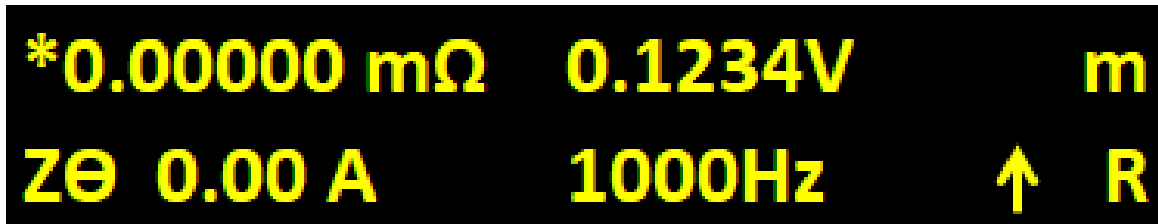

Figure 3.1 Primary Measurement Mode

The following measurements can be obtained:

Measurement	Description
DC	Displays the battery's DC voltage and current.
Z θ	Displays the impedance (magnitude)
Xs	Series mode: Displays the real and imaginary impedance.
Xp	Parallel mode: Displays the real and imaginary impedance.
Cs	Series mode: Displays the resistance and capacitance.
Cp	Parallel mode: Displays the resistance and capacitance.
Ls	Series mode: Displays the resistance and inductance.
Lp	Parallel mode: Displays the resistance and inductance.
QD	Displays quality factor and dissipation factor.
V θ	Displays the voltage magnitude and phase.
I θ	Displays the current magnitude and phase
Vx	Displays the voltage in cartesian form.
Ix	Displays the current in cartesian form.

Table 3.1 Measurement Modes

Measurement Setup

Follow the instructions in [2.5](#) to ensure cabling will not have a major impact on the measurements.

Note:

The sweep function as well as plot functions are only available through the BK-FRA software. Only the measurements listed in [Chapter 3](#) can be obtained through the unit's display.

The following settings may be entered either through the front panel or through the remote interfaces.

4.1 Setting DC Current Level

The DC current component defines the load applied to the battery. Measurements of a battery at different test currents provides more information about the battery. Different load currents may be necessary depending on the size of the battery.

1. Press the **Shift** button then press **DCI 1**.
2. Enter the load current using the numeric keypad.
3. Press the **Enter** button to confirm the set value.

4.2 Setting AC Current Level

The AC current component stimulates the battery. The amplitude of this signal is critical for accurate measurement of the battery internal resistance. This value is directly related to the measureable voltage generated by the battery's internal resistance. Therefore, batteries with smaller internal resistance value require larger AC current test. For larger internal resistances a large test signals will generate a large voltage signal. The input gain of the system needs to change depending on the signal level.

1. Press the **Shift** button then press **ACI 2**.
2. Enter the AC stimulus current using the numeric keypad.
3. Press the **Enter** button to confirm the set value.

Note:

The AC current level should be set to approximately 10% of the set DC Current level.

4.3 Setting Frequency and Sweep

It is standard to test batteries at 1KHz. However, measurements across a range of frequencies provide more information than a single resistance measurement (at steady state or DC loading). To test across a range of frequencies use sweep mode. **Sweep mode is only available through the software provided.**

4.3.1 Single Frequency

1. Press the **Shift** button then press **Freq 3**.
2. Enter the AC frequency using the numeric keypad.
3. Press the **Enter** button to confirm the set value.

4.3.2 Sweep Mode

To access sweep mode use the BK-FRA software. More information on installing the software in chapter 6.

Figure 4.1 demonstrates the configurable parameters in sweep mode.

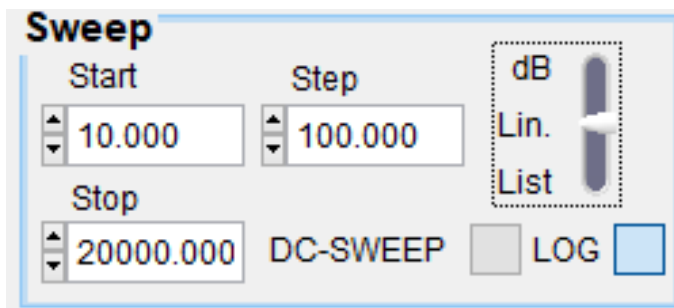

Figure 4.1 Software Sweep Mode

- **Start:** Set the starting frequency of the sweep.
- **Stop:** Set the stopping frequency of the sweep.
- **Step:** Set the steps in the sweep. Only available in Control Panel when Lin mode is set.
- **dB:** Set the start and stop frequency for a logarithmic sweep.
- **Lin:** Set the start, stop and step frequency for linear sweep.
- **List:** Create a custom sweep. A separate window will open allowing the user to customize up to 40 steps in a sweep. See figure 4.2
- **DC-SWEEP:** Performs multiple frequency sweeps at user-defined load levels set in Edit (10 sweeps max).
- **LOG:** Save the recorded data to selected path.

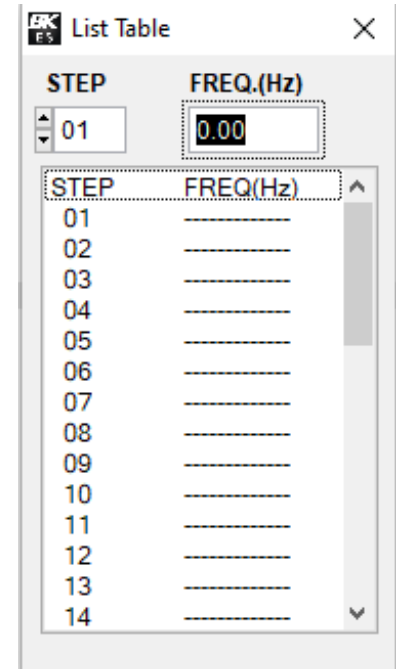

Figure 4.2
Software List Mode

A sweep yields more information about the DUT. The data collected can be graphed and recorded. See section 6 for details on how to graph the sweep and record the data.

Note:

As frequency increases, the physical arrangement of the test leads has a greater impact. Reduce the loop area created by the test leads when working at higher frequencies to reduce the inductance of the cabling.

4.4 Making a Measurement

Once the appropriate stimulus values have been specified, connect the battery. Press **On/Off** to enable the load and the stimulus signal. Press the **Menu Mode** button to cycle between the different measurement modes. See section 3 for more details.

To take measurements using the sweep function see section 6.4.

Note:

Once you obtain a measurement press the **On/Off** button to disable the load and the stimulus signal. This prevents the battery from being discharged.

Verification Test



Figure 5.1 Self-Test Fixture

The Self-Test Fixture (TLC81) serves two functions: it verifies the BA8100 meets the accuracy and resolution specifications, and is used as a reference when a user calibration is conducted. A user calibration is a compensation procedure used to reduce the impedance introduced by the test leads. It **does not** issue data to create a report or certificate of calibration that confirms conformance with its specifications.

The user calibration procedure can be completed to the front panel or to the test leads. The BA8100 uses a single memory location to store the compensation data. This memory will be over written each time the user calibration is completed. Therefore, prior to conducting a verification test the user calibration procedure must be completed to the front panel.

Note:

Out of the box the compensation data stored in the memory will be for the front panel. It is recommended a verification test is conducted to ensure the instrument is working as expected.

The **Verification Procedure** should be completed when the user has concerns with user calibration to the test leads or if there is doubt about the the instrument's calibration. If the **Verification Procedure to the Front Panel** does not provide conforming result after completing a user calibration to the front panel, the unit must be sent back to be calibrated.

5.1 Verification Procedure

The verification procedure can be conducted to the front panel or to the test leads. Verification to the test leads should be completed when there is a change in the position of the leads that can affect the impedance. Changes in looping, tension, or environmental parameters of the test leads can cause the compensation values to become obsolete.

If after completing a user calibration to the test leads the verification test to the leads is still failing, the next step is to complete a user calibration to the front panel and conduct the verification procedure to the front panel. If the verification to the front panel also fails the BA8100 will have to be sent in for repair and calibration.

Note:

The BA8100 along with the TLC81 when must be shipped together when sent in for repair or calibration.

Materials Required

- **BA8100**
- **TLC81, Self-Test Fixture with matching serial number to the BA8100**
- **Power supply**
 - Any power with an output of 5 V and 3A is required.

Note:

The TLC81 is matched to the BA8100 by the manufacturer. If the TLC81 serial number does not match the BA8100 serial number contact the distributor.

5.2 Verification Procedure to the Front Panel

5.2.1 Verification Setup

Before initiating the verification to the front panel verify that the last user calibration was completed to the front panel.

1. Set the BA8100 to Z0 mode.
2. Connect the TLC81 to the BA8100. The fixture directly connects to the four inputs located in the front panel.

Note:

Verify the arrow on the TLC81 is facing up.



Figure 5.2 TLC81 Verification Measurement

3. Connect the power supply to the TLC81's power input.
4. Set the power supply's voltage to 5 V and the current limit to 3 A.
5. Set the **DCI** to **2 A** and **ACI** to **200 mArms**.
6. Enable the BA8100 and the power supply's output.
7. If the unit is within calibration and functioning properly the measurement will fall between 4.9700 and 5.0300 mΩ $\pm(0.5\% \text{ of reading} + 5 \mu\Omega)$.



Figure 5.3 TLC81 Verification Measurement

5.3 Compensating to the Test Leads

5.3.1 Setup

Before initiating the verification to the test leads verify that the last user calibration was completed to the test leads.

1. Set the BA8100 to Z0 mode.
2. Connect the test leads to the BA8100.
Verify the leads are connected to the corresponding terminals.
See section [Connections](#).
3. Clamp the alligator clips to corresponding plate. Ensure the clips are clamped to the corresponding side. Silkscreen labeling instructs how to clamp the test leads. See figure [5.4](#)



Figure 5.4 Verification-Test to Test Leads

4. Connect the power supply to the TLC81's power input.
5. Set the power supply's voltage to 5 V and its current to set DCI of the BA8100 (Recommended load: .5 A).
6. Enable the BA8100 input and the power supply's output.
7. If the unit is within calibration and functioning properly it will measure $5.0000 \text{ m}\Omega \pm(0.5 \% \text{ of reading} + 5 \text{ }\mu\Omega)$.
 - The BA8100 is calibrated to the front panel. Calibration to the test leads is required in order to meet the impedance measurement specifications.
 - Small changes in test lead position as well as environment changes can have an effect on the instrument reading. The calibration and verification setup must be the same to meet specifications. To perform a user calibration to the test leads refer to section [5.4.1](#)

5.4 User Calibration

⚠ WARNING

Configuration of the settings in calibration mode can change the unit's measurement accuracy. Only adjustments to the ACA Ratio should be made.

5.4.1 User Calibration to the Test Leads

To perform a user calibration to the test leads connect the leads front the front panel to the TLC81. Power the TLC81 using a 5 V 3 A source. Before starting the user calibration procedure ensure your setup is complete. Making adjustment to the setup, such as removing the twist in the test leads, will effect the calibration ratios. The setup should be similar to the one shown in figure 5.5 with adjustments to position of the test leads.

The leads should be laid in the position that will be used for testing.

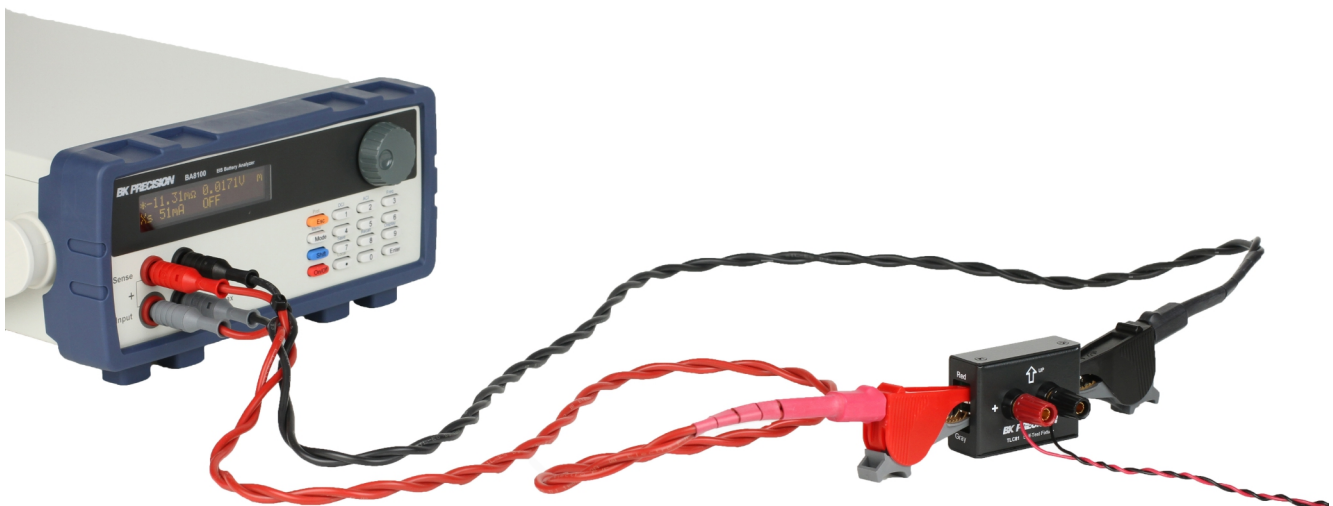

Figure 5.5 Self-Test Calibration Verification to Test Leads

1. Enter **back-door mode** by pressing **Enter** + **Prot Esc**. Once you enter back-door "Z0" will flash on the OLED.
2. Enter Calibration Menu by pressing **Enter** + **0**.
3. Use the rotary knob to navigate through the Calibration Menu.
4. Select ACA Ratio.
 - Set the RUT value to 5.0000 mΩ.
 - Press **Enter** to begin the compensation adjustment.
 - This process can take up to 5 mins to complete.

5. Select LOF ACA Ratio.
 - Set the RUT value to 5.0000 mΩ.
 - Press **Enter** to begin the compensation adjustment.
 - This process can take up to 20 mins to complete.
6. After both ACA Ratio and LOF ACA Ratio have been adjusted select **Save Data** to save the new ratios.
7. To return to previous menu press **Prot Esc**.
8. To exit Back-door press **Enter** + **Prot Esc**.
9. Power cycle the instrument.

Note:

Calibrating to the test leads will modify the initial calibration to the front panel. Verification to the front panel may not meet specification.

5.4.2 User Calibration to the Front Panel

To calibrate the unit to the front panel the TLC81 must be connected to the front panel and powered by a 5 V 3 A source.



Figure 5.6 Compensating to the Front Panel

1. Enter **back-door mode** by pressing **Enter** + **Prot Esc**. Once you enter back-door "Zθ" will flash on the OLED.
2. Enter Calibration Menu by pressing **Enter** + **0**.

3. Use the rotary knob to navigate through the Calibration Menu.
4. Select ACA Ratio.
 - Set the RUT value to 5.0000 mΩ.
 - Press **Enter** to begin the compensation adjustment.
 - This process can take up to 5 mins to complete.
5. Select LOF ACA Ratio.
 - Set the RUT value to 5.0000 mΩ.
 - Press **Enter** to begin the compensation adjustment.
 - This process can take up to 20 mins to complete.
6. After both ACA Ratio and LOF ACA Ratio have been adjusted select **Save Data** to save the new ratios.
7. To return to previous menu press **Prot Esc**.
8. To exit Back-door press **Enter** + **Prot Esc**.

Operating Software

6.1 Software Installation

The software can be found in the BK Precision website under the product's page Docs & Software tab.

Download the BK-FRA software and install it.

Before you launch the software:

1. Connect the BA8100 and PC using a USB cable.
2. Connect the BA8100 into an AC plug.
3. Turn on the power switch.
4. Open the Windows Device Manager. After a few minutes you should see the USB device manager installed, and a COM Port will be assigned by Windows under Deveice Manager > Ports.
5. Take a note of the COM Port number.
6. Launch the software.

6.2 Interface Configuration

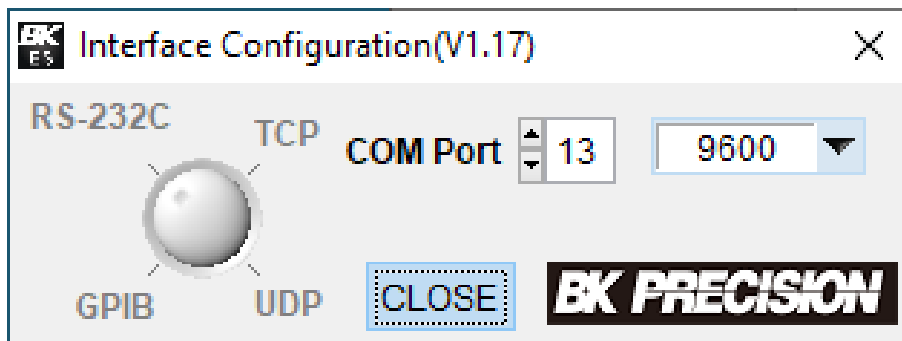

Once the interface configuration window opens:

1. Set the knob to the remote interfaced that will be used to control the instrument.
 - Set the interface Parameters:
 - **RS-232**: Set the **COM Port** to match the assigned port noted in the device manager, and the baudrate of the instrument.
 - **TCP**: Set the IP Address.
2. Click open to launch the software.
 - The BA8100 Control Panel will launch as shown in **Figure 6.1**

6.3 Control Panel

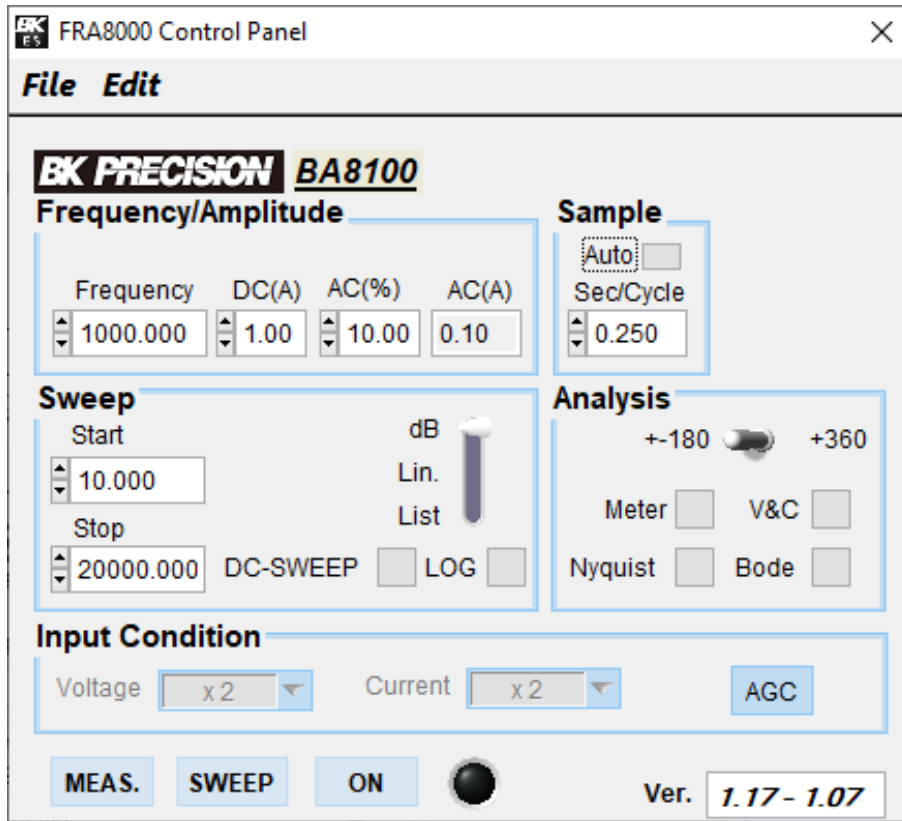

Figure 6.1 Control Panel

The **Control Panel** is separated into 6 sections:

1. **Frequency/Amplitude**
2. **Sweep**
3. **Analysis**
4. **Sample**
5. **Output Condition**
6. **Output State**

6.3.1 Frequency/Amplitude

Set the parameters of the alternating current signal.

- **Frequency:** Sets the frequency of the AC signal making a single point measurement(sweep is disabled).
- **DC(A):** Sets the value of the steady state load applied to the battery. (3.00 A Max)
- **AC(%):** Sets the percentage ratio between DC and AC signals. (16% Max)
- **AC(A):** Sets the level of signal that stimulates the battery.

6.3.2 Sweep

- **Start:** Set the starting frequency of the sweep.
- **Stop:** Set the stopping frequency of the sweep.
- **dB:** Set the start and stop frequency for a logarithmic increment sweep.
- **Lin:** Set the start, stop and step frequency for linear increment sweep based on the **Step** value set.
 - **Step:** Set the frequency increment for each step of the sweep. Only available when linear increments(**Lin**) mode is set.
- **List:** Create a custom sweep. A separate window will appear allowing the customization of 40 steps in a sweep. See [Figure 6.3](#)
- **DC-SWEEP:** Enable multiple sweeps with different DCI and ACI parameters.
 - To configure the parameters of each sweep click **Edit > DC/AC Sweep**.
 - A separate window will appear allowing for customization of 10 steps(sweeps). See [Figure 6.4](#)
- **LOG:** Enable logging of the collected data to selected path.
 - Upon completing the sweep the **File Save Dialog Window** will appear.
 - The default location is the BK-FRA folder created during installation. See [Figure 6.2](#)

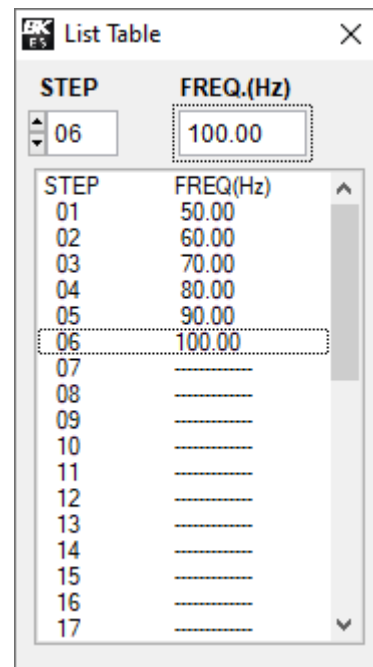

Figure 6.3 List Sweep

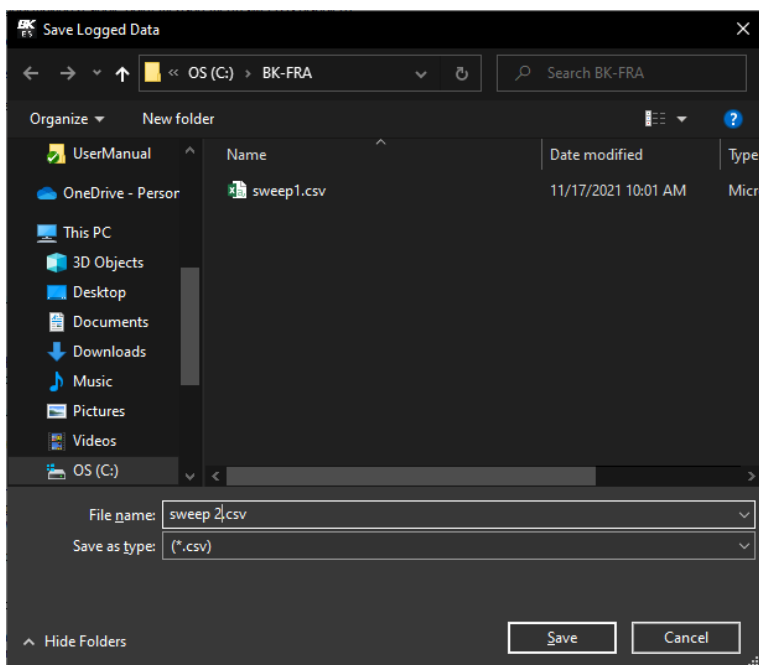

Figure 6.2 Save Log

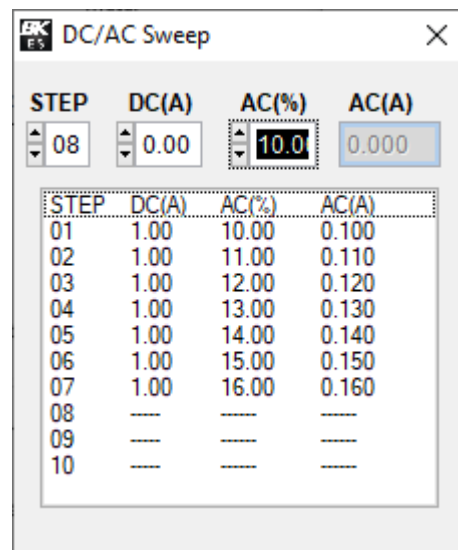

Figure 6.4 DC/AC Sweep

6.3.3 Analysis

- **+/-180/ +360:** Switch the display format of all **Degree** measurements to either **+/-180** or **+360**.
- **Meter:** Opens the **Impedance Meter** window.
 - Clicking the **MEAS.** button will enable measurements.
 - Displays the measurements that are currently being acquired by the BA8100. See **Figure 6.6**.
- **V&C:** Opens the **Voltage & Current** window.
 - Graphs the magnitude and pahse of the acquired AC voltage and current in the frequency spectra. See **Figure 6.5**

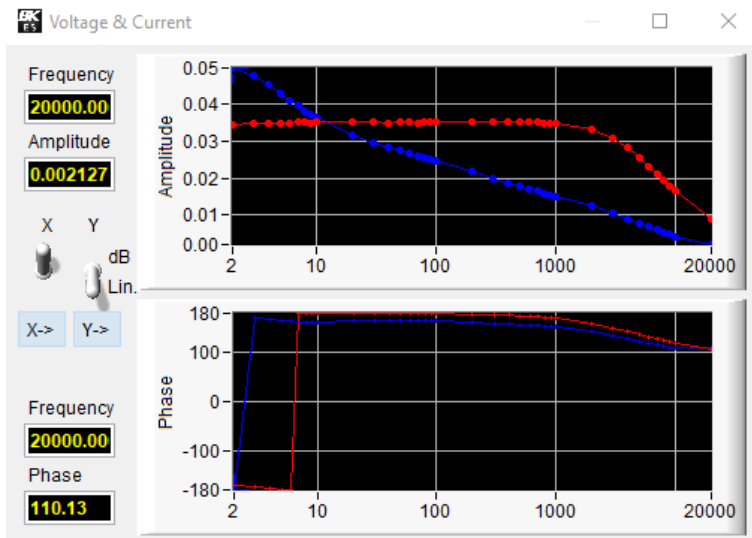

Figure 6.5 Voltage & Current Graph

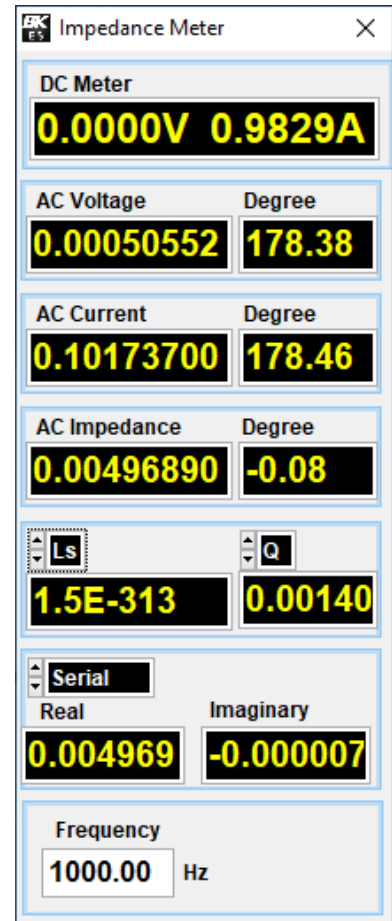

Figure 6.6 Impedance Meter

- **Nyquist:** Opens the **Impedance Nyquist** window.
 - Graphs the real vs the imaginary part of the impedance as functions of frequency.
 - Enabling **Freq. Marker** will display the frequency value at which the selected point was measured.

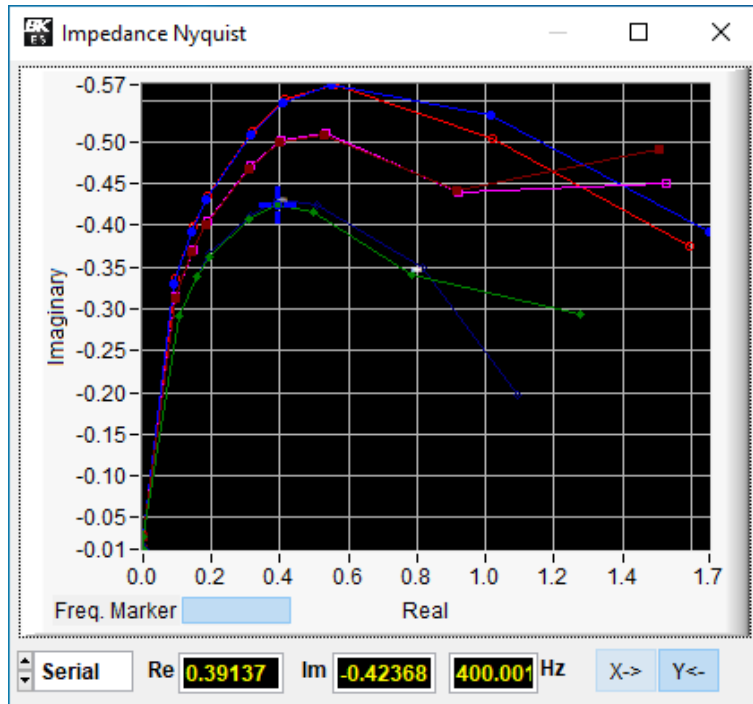

Figure 6.7 Impedance Nyquist

- **Bode:** Opens the **Impedance Bode** window.
 - Graphs the phase shift and magnitude changes of impedance across the applied frequency range.
 - Enabling **Freq. Marker** will display the frequency value at which the selected point was measured.
 - The parameters shown in **Figure 6.8** can be graphed.

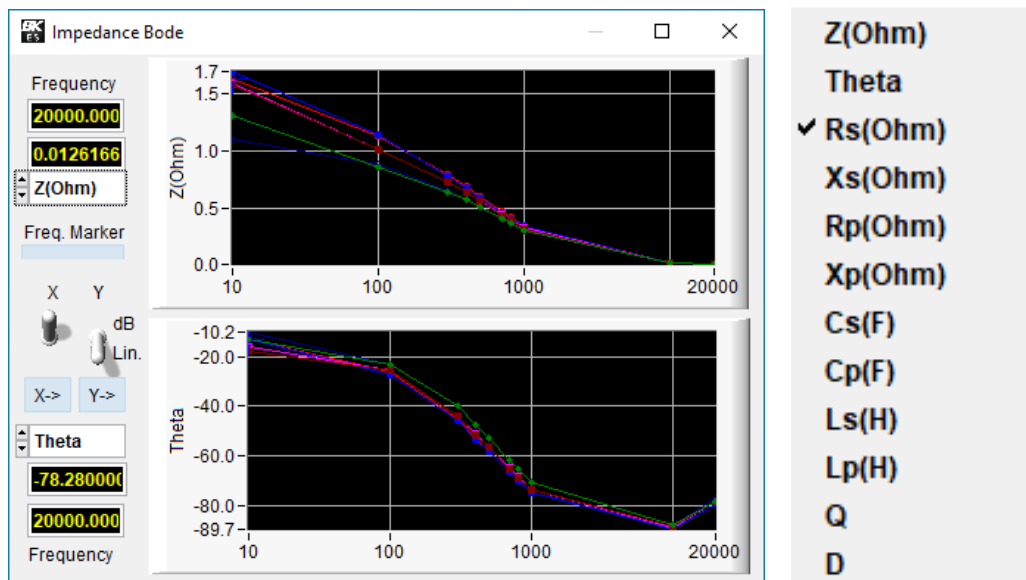

Figure 6.8 Bode Plot

6.3.4 Sample

- **Sec/Cycle** Sets the dwell time of each step.
 - Enabling **Auto** will set the dwell time based on the time required for the frequency to acquired data. (Smaller frequencies require more time to acquire data.)

6.3.5 Output Condition

- **AGC (Automatic Gain Compensation)**: Enable/disable automatic gain compensation.
 - When disabled the **Voltage** and **Current** gain can manually be adjusted.

Note:

It is recommended AGC be set to automatic.

Output State

- **Meas.:** Enable/disable measurement acquisition.
- **Sweep:** Enable/disable sweep mode.
- **ON/OFF:** Enable/disable AC signal output.

6.4 Running the Test



MEAS, SWEEP, and On can be found at the bottom of the control panel.

Click the **ON** button enables the load and the stimulus signal.

Select the desired **analysis**. (Meter, Nyquist, V & C, or Bode)

Click the **SWEEP** button to start the sweep.

Click **MEAS.** button to continuously acquire measurements. These measurement can viewed in the meter but are overwritten when a new measurement is taken. Clicking pause will end the measurement acquisition and display the last measurement taken.

Disable the load after each measurement is complete to prevent the battery from being drained.

6.5 Test Results

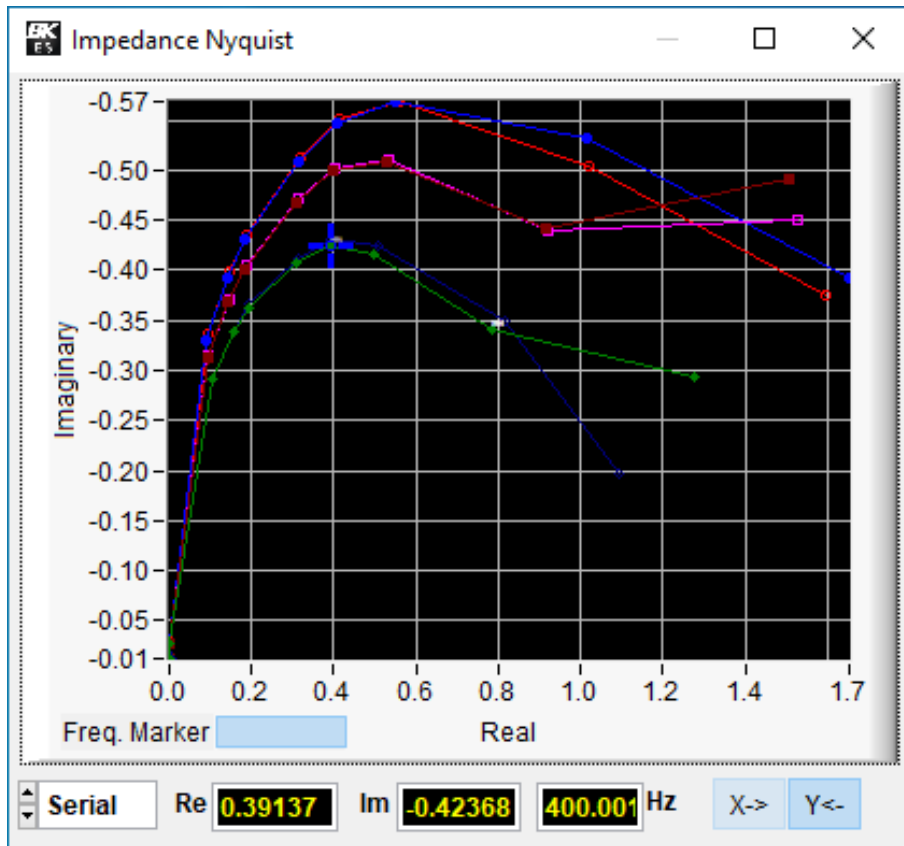

The sweep can be plotted in a Nyquist, Voltage and Current, or Bode plot. These plots must be analyzed to interpret various parameters of the DUT.

6.6 Data Logging

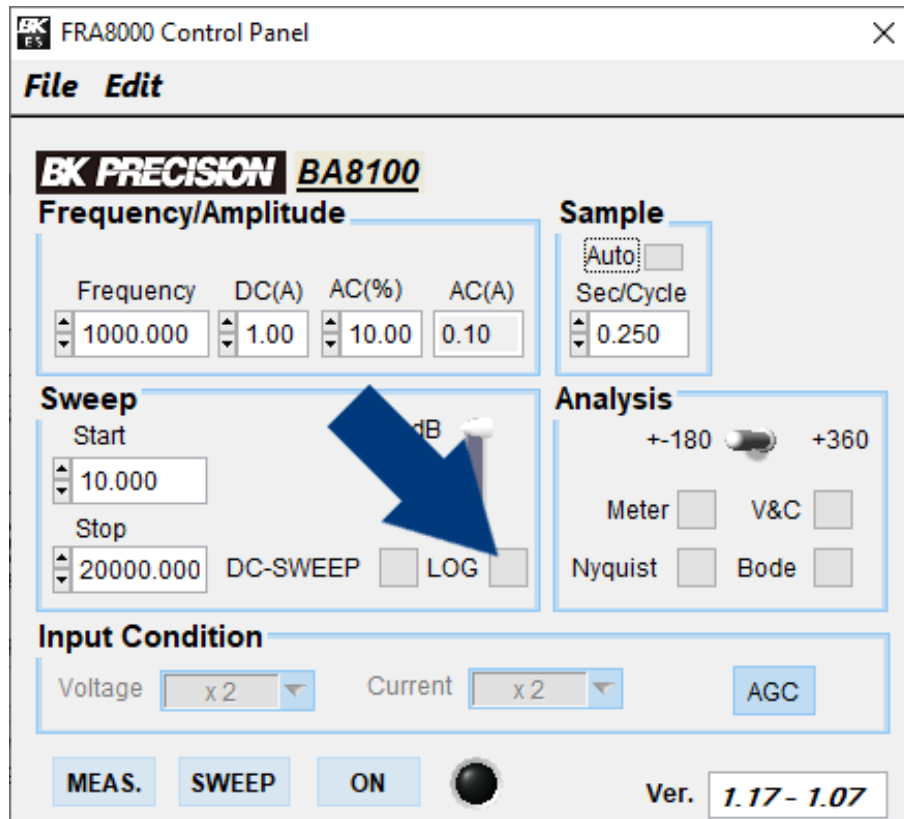

Check the LOG box to record the data collected. The box is highlighted blue when checked. The file path can be set once the sweep elapse. The data is saved as a .CSV file.

System Setup

Press the **Shift** button then press the **Menu Mode** button to enter the system menu. Use the rotary knob  to navigate between each menu and setting. The button integrated in the knob navigates up one menu level if available. Press the **Enter** button to enter the selected menu.

- + Indicates there are more items within the selected menu item.
- = Indicates there are no further items within the selected menu item.
Pressing **Enter** navigates into the menu where the setting value is changed or viewed.

7.1 Menu

- Input Settings** Load/stimulus input section settings
- Display Settings** Select format and unit of parameters.
- I/O Config** Select remote interface.
- Protection** Set protection settings.
- System Setup** Set system setup settings.

7.1.1 Input Settings

- AGC** Automatic gain compensation.
Default: ON
- Sample Interval** Measurement period between samples
Default: 199ms
- Auto Sample** Automatically sample points
Default: ON
- Current Gain** Current measurement sensitivity (gain)
Default: x450
- Voltage Gain** Voltage measurement sensitivity (gain)
Default: x450

7.1.2 Display Settings

- Phase Format** Phase angle display format. ± 180 or 360 degrees
Default: ± 180

7.1.3 I/O Configuration

- RS232 Baud Rate** RS-232 communication speed (4800, 9600, 19200, 38400, 57600, 115200)
Default: 9600
- Term Character** Serial transmission termination character. Carriage return (CR), Line Feed (LF) or both (CR+LF).
Default: CR + LF
- Network** Ethernet/LAN settings. DHCP is not supported.
- IP Address
 - Gateway IP
 - Subnet Mask

7.1.4 Protection

- Auto Cut-Off** Automatically turn off the input after a given time.
Default: OFF
- UV Protection** Under-voltage protection - shuts off the input when the voltage reaches the limit.
Default: 00.00V
- OV Protection** Over-voltage protection - shuts off the input when the voltage reaches the limit.
Default: 88.00V

7.1.5 System Setup

- Beeper** Key beep - ON or OFF
Default: ON
- Clear Memory** Clear all data.
- Security Code** Set a security code.
- Key Lock** Lock the keys in the front panel.

Note:

Operation Time can be view by pressing **Enter** + **Menu Mode**

Remote Interface

The BA8100 can be remotely controlled over the USBVCP, RS232, or LAN.

To control the instrument using the FRA operation software provided by BK Precision:

1. Install the FRA software and NI VISA.
 - Follow the instructions given in Ch 6.
2. Connect the device interface at the rear panel of BA8100 Series with a PC via a USB, RS232, or LAN.

Note:

The BA8100 automatically switches to active remote interface when connected to remote interface.

8.1 USBVCP

The Port Settings are as followed:

Baud rate: 9600

Data bits: 8

Parity: None

Stop bits: 1

Flow control: None

8.2 RS-232

A crossover cable is required to establish communication.

The baudrate is configured in the “I/O Config” menu.

8.3 Ethernet

This interface is configured in the “I/O Config” menu.

Telnet and rawsocket are supported over port 3000.

8.4 Local and Remote Mode

When using the analyzer via a remote interface, the keypad is locked out. To re-enable

local control, press  .

Specifications

Note: All specifications apply to the unit after a temperature stabilization time of 30 minutes over an ambient temperature range of 23 °C ± 5 °C.

BA8100		
Input		
Voltage		0.5 V to 80 V
Power		200 W maximum (dissipated by internal load)
Settings		
Current	DC	0.5 A to 3 A (dissipated by internal load)
	Modulating AC Current	50 mArms to 300 mArms (10% of DCA typical)
Modulating Frequency	Range	0.05 Hz to 10 kHz
	Resolution (Auto)	0.001 Hz to 0.1 Hz
	Accuracy	0.01% of setting
Displayed Parameters		
Primary		X, Z, V, I, Freq.
Secondary		Rs, Rp, Xs, Xp, Cs, Cp, Ls, Lp, Q, D, and θ
Measurements		
Voltage 4-wire	Range	0 V to 80 V
	Resolution	0.1 mV
	Accuracy (ACI = 0) ⁽¹⁾	0.05% of reading + 0.05% of full scale
DC Sink Current	Range	0 A to 3 A
	Resolution	0.1 mA
	Accuracy (ACI = 0) ⁽¹⁾	0.5% of reading + 0.1% of full scale
Resistance R Auto sampling interval (8 to 10 cycles) and auto range enabled	Displayed Digits	5 digits including sign
	Resolution	1 $\mu\Omega$
	Accuracy (10 Hz to 10 kHz)	$\pm(0.5\%$ of reading + 5 $\mu\Omega)$
Impedance Z Auto sampling interval (8 to 10 cycles) and auto range enabled	Displayed Digits	5 digits including sign
	Resolution	1 $\mu\Omega$
	Accuracy (10 Hz to 10 kHz)	$\pm(0.5\%$ of reading + 5 $\mu\Omega)$
Phase Angle θ	Range	-180° to 180°
	Resolution	0.01°
	Accuracy	$\pm 0.3^\circ$
General		
AC Input		100 VAC to 240 VAC, 50/60 Hz
UUT Connector		4-terminal banana jack
I/O Interfaces		LAN, USB (Virtual COM), RS232
Operating Temperature		32° F to 104° F (0° C to 40° C)
Storage Temperature		14° F to 122° F (-10° C to 50° C)
Dimension (W x H x D)		8.5 " x 3.5" x 14.6" (215 x 90 x 370 mm)
Weight		9.9 lbs (4.5 kg)
Software		Bundled software for fixed or frequency sweep, Nyquist and Bode plots
Warranty		3 Years
Standard Accessories		Power cord, kelvin clip test leads, calibration certificate, calibration test fixture (TLC81)

(1) The accuracy of DC voltage and current should be under no modulation condition (i.e. AC current = 0).

Service Information

Warranty Service: Please go to the support and service section on our website at bkprecision.com to obtain an RMA #. Return the product in the original packaging with proof of purchase to the address below. Clearly state on the RMA the performance problem and return any leads, probes, connectors and accessories that you are using with the device.

Non-Warranty Service: Please go to the support and service section on our website at bkprecision.com to obtain an RMA #. Return the product in the original packaging to the address below. Clearly state on the RMA the performance problem and return any leads, probes, connectors and accessories that you are using with the device. Customers not on an open account must include payment in the form of a money order or credit card. For the most current repair charges please refer to the service and support section on our website.

Return all merchandise to B&K Precision Corp. with prepaid shipping. The flat-rate repair charge for Non-Warranty Service does not include return shipping. Return shipping to locations in North America is included for Warranty Service. For overnight shipments and non-North American shipping fees please contact B&K Precision Corp.

Include with the returned instrument your complete return shipping address, contact name, phone number and description of problem.

B&K Precision Corp.
: 22820 Savi Ranch Parkway
Yorba Linda, CA 92887
bkprecision.com
714-921-9095

LIMITED THREE-YEAR WARRANTY

B&K Precision Corp. warrants to the original purchaser that its products and the component parts thereof, will be free from defects in workmanship and materials for a period of **three years** from date of purchase.

B&K Precision Corp. will, without charge, repair or replace, at its option, defective product or component parts. Returned product must be accompanied by proof of the purchase date in the form of a sales receipt.

To help us better serve you, please complete the warranty registration for your new instrument via our website www.bk-precision.com

Exclusions: This warranty does not apply in the event of misuse or abuse of the product or as a result of unauthorized alterations or repairs. The warranty is void if the serial number is altered, defaced or removed.

B&K Precision Corp. shall not be liable for any consequential damages, including without limitation damages resulting from loss of use. Some states do not allow limitations of incidental or consequential damages. So the above limitation or exclusion may not apply to you.

This warranty gives you specific rights and you may have other rights, which vary from state-to-state.

B&K Precision Corp.
22820 Savi Ranch Parkway
Yorba Linda, CA 92887
www.bkprecision.com
714-921-9095