

FLUKE®

2640A/2645A

NetDAQ®

Networked Data Acquisition Unit

Users Manual

PN 942623

May 1994, Rev 2 11/96

© 1994, 1995, 1996 Fluke Corporation, All rights reserved. Printed in U.S.A.

All product names are trademarks of their respective companies.

LIMITED WARRANTY & LIMITATION OF LIABILITY

Each Fluke product is warranted to be free from defects in material and workmanship under normal use and service. The warranty period is one year and begins on the date of shipment. Parts, product repairs and services are warranted for 90 days. This warranty extends only to the original buyer or end-user customer of a Fluke authorized reseller, and does not apply to fuses, disposable batteries or to any product which, in Fluke's opinion, has been misused, altered, neglected or damaged by accident or abnormal conditions of operation or handling. Fluke warrants that software will operate substantially in accordance with its functional specifications for 90 days and that it has been properly recorded on non-defective media. Fluke does not warrant that software will be error free or operate without interruption.

Fluke authorized resellers shall extend this warranty on new and unused products to end-user customers only but have no authority to extend a greater or different warranty on behalf of Fluke. Warranty support is available if product is purchased through a Fluke authorized sales outlet or Buyer has paid the applicable international price. Fluke reserves the right to invoice Buyer for importation costs of repair/replacement parts when product purchased in one country is submitted for repair in another country.

Fluke's warranty obligation is limited, at Fluke's option, to refund of the purchase price, free of charge repair, or replacement of a defective product which is returned to a Fluke authorized service center within the warranty period.

To obtain warranty service, contact your nearest Fluke authorized service center or send the product, with a description of the difficulty, postage and insurance prepaid (FOB Destination), to the nearest Fluke authorized service center. Fluke assumes no risk for damage in transit. Following warranty repair, the product will be returned to Buyer, transportation prepaid (FOB Destination). If Fluke determines that the failure was caused by misuse, alteration, accident or abnormal condition of operation or handling, Fluke will provide an estimate of repair costs and obtain authorization before commencing the work. Following repair, the product will be returned to the Buyer transportation prepaid and the Buyer will be billed for the repair and return transportation charges (FOB Shipping Point).

THIS WARRANTY IS BUYER'S SOLE AND EXCLUSIVE REMEDY AND IS IN LIEU OF ALL OTHER WARRANTIES, EXPRESS OR IMPLIED, INCLUDING BUT NOT LIMITED TO ANY IMPLIED WARRANTY OF MERCHANTABILITY OR FITNESS FOR A PARTICULAR PURPOSE. FLUKE SHALL NOT BE LIABLE FOR ANY SPECIAL, INDIRECT, INCIDENTAL OR CONSEQUENTIAL DAMAGES OR LOSSES, INCLUDING LOSS OF DATA, WHETHER ARISING FROM BREACH OF WARRANTY OR BASED ON CONTRACT, TORT, RELIANCE OR ANY OTHER THEORY.

Since some countries or states do not allow limitation of the term of an implied warranty, or exclusion or limitation of incidental or consequential damages, the limitations and exclusions of this warranty may not apply to every buyer. If any provision of this Warranty is held invalid or unenforceable by a court of competent jurisdiction, such holding will not affect the validity or enforceability of any other provision.

Fluke Corporation
P.O. Box 9090
Everett WA
98206-9090

Fluke Europe B.V.
P.O. Box 1186
5602 B.D.
Eindhoven
The Netherlands



Caution

This is an IEC safety Class 1 product. Before using, the ground wire in the line cord or rear panel binding post must be connect to an earth ground for safety.

Interference Information

This equipment generates and uses radio frequency energy and if not installed and used in strict accordance with the manufacturer's instructions, may cause interference to radio and television reception. It has been type tested and found to comply with the limits for a Class B computing device in accordance with the specifications of Part 15 of FCC Rules, which are designed to provide reasonable protection against such interference in a residential installation.

Operation is subject to the following two conditions:

- This device may not cause harmful interference.
- This device must accept any interference received, including interference that may cause undesired operation.

There is no guarantee that interference will not occur in a particular installation. If this equipment does cause interference to radio or television reception, which can be determined by turning the equipment off and on, the user is encouraged to try to correct the interference by one of more of the following measures:

- Reorient the receiving antenna
- Relocate the equipment with respect to the receiver
- Move the equipment away from the receiver
- Plug the equipment into a different outlet so that the computer and receiver are on different branch circuits

If necessary, the user should consult the dealer or an experienced radio/television technician for additional suggestions. The user may find the following booklet prepared by the Federal Communications Commission helpful: How to Identify and Resolve Radio-TV Interference Problems. This booklet is available from the U.S. Government Printing Office, Washington, D.C. 20402. Stock No. 004-000-00345-4.

Declaration of the Manufacturer or Importer

We hereby certify that the Fluke Model 2640A/2645A Networked Data Acquisition Unit is in compliance with BMPT Vfg 243/1991 and is RFI suppressed. The normal operation of some equipment (e.g. signal generators) may be subject to specific restrictions. Please observe the notices in the users manual. The marketing and sales of the equipment was reported to the Central Office for Telecommunication Permits (BZT). The right to retest this equipment to verify compliance with the regulation was given to the BZT.

Bescheinigung des Herstellers/Importeurs

Hiermit wird bescheinigt, daß Fluke Models 2640A/2645A Networked Data Acquisition Unit in Übereinstimmung mit den Bestimmungen der BMPT-AmtsblVfg 243/1991 funk-entstört ist. Der vorschriftsmäßige Betrieb mancher Geräte (z.B. Meßsender) kann allerdings gewissen Einschränkungen unterliegen. Beachten Sie deshalb die Hinweise in der Bedienungsanleitung. Dem Bundesamt für Zulassungen in der Telekommunikation wurde das Inverkehrbringen dieses Gerätes angezeigt und die Berechtigung zur Überprüfung der Seire auf Einhaltung der Bestimmungen eingeräumt.

Fluke Corporation

SAFETY TERMS IN THIS MANUAL

This instrument has been designed and tested in accordance with IEC publication 1010-1, *Safety Requirements for Electrical Measuring, Control and Laboratory Equipment*. This Users Manual contains information, warnings and cautions. Use of this equipment in a manner not specified herein may impair the protection provided by the equipment.

This instrument is designed for IEC 1010-1 Installation Category II use.

WARNING statements identify conditions or practices that could result in personal injury or loss of life.

CAUTION statements identify conditions or practices that could result in damage to equipment.

SYMBOLS MARKED ON EQUIPMENT:



WARNING Risk of electric shock.



Ground (earth) terminal.



Protective ground (earth) terminal. Must be connected to safety earth ground when the power cord is used.



Attention. Refer to the manual (see the Index for references). This symbol indicates that information about usage of a feature is contained in the manual. This symbol appears on the Universal Input Module and in the following three places on the instrument rear panel:

1. Ground Binding Post (to the left of the line power connector).
2. Ground Binding Post (to the left of the 10Base2 connector).
3. ALARM/TRIGGER I/O and DIGITAL I/O connectors.

AC POWER SOURCE

The instrument is intended to operate from an ac power source that will not apply more than 264V ac rms between the supply conductors or between either supply conductor and ground. A protective ground connection by way of the grounding conductor in the power cord is required for safe operation.

DC POWER SOURCE

The instrument may also be operated from a 9V to 16V dc power source when either the rear panel ground binding post or the power cord grounding conductor is connected properly.

USE THE PROPER FUSE

To avoid fire hazard, for fuse replacement use only a 1/4 ampere, 250V non-time delay line fuse.

GROUNDING THE INSTRUMENT

The instrument utilizes controlled overvoltage techniques that require the instrument to be grounded whenever normal mode or common mode ac voltages or transient voltages may occur. The enclosure must be grounded through the grounding conductor of the power cord, or if operated on battery with the power cord unplugged, through the rear panel ground binding post.

USE THE PROPER POWER CORD

Use only the power cord and connector appropriate for the voltage and plug configuration in your country.

Use only a power cord that is in good condition.

Refer power cord and connector changes to qualified service personnel.

WARNING!

DO NOT OPERATE IN EXPLOSIVE ATMOSPHERES

To avoid personal injury or death, do not remove the instrument cover without first removing the power source connected to the rear panel. Do not operate the instrument without the cover properly installed. Normal calibration is accomplished with the cover closed. There is no need for the operator to remove the cover except to replace the fuse. Access procedures and the warnings for such procedures are contained both in this manual and in the Service Manual. Service procedures are for qualified service personnel only.

DO NOT ATTEMPT TO OPERATE IF PROTECTION MAY BE IMPAIRED

If the instrument appears damaged or operates abnormally, protection may be impaired. Do not attempt to operate the instrument under these conditions. Refer all question of proper instrument operation to qualified service personnel.

Table of Contents

Chapter	Title	Page
1	Overview	1-1
1-1.	Introduction	1-3
1-2.	Instrument Features and Capabilities	1-4
1-3.	Analog Channels	1-7
1-4.	Computed Channels	1-7
1-5.	Channel Numbering	1-7
1-6.	Mx+B Scaling	1-7
1-7.	Alarms	1-8
1-8.	Channel Monitoring	1-8
1-9.	Digital I/O	1-8
1-10.	Totalizer	1-8
1-11.	Trigger Input	1-9
1-12.	Trigger Output.....	1-9
1-13.	Master Alarm	1-10
1-14.	Interval Trigger	1-10
1-15.	External Trigger	1-10
1-16.	Alarm Trigger.....	1-10
1-17.	NetDAQ Logger Features and Capabilities.....	1-11
1-18.	Operating a NetDAQ Data Acquisition System.....	1-11
1-19.	Isolated Networks.....	1-12
1-20.	General Networks.....	1-12
1-21.	Ethernet Port Selection	1-12
1-22.	Asynchronous Instrument Operations.....	1-12
1-23.	Group Instrument Operations.....	1-12
1-24.	Scanning and Logging.....	1-13
1-25.	RS-232 Interface	1-13
1-26.	Host Computer Requirements	1-14
1-27.	Options and Accessories	1-14
1-28.	Instrument Connector Set.....	1-15
1-29.	Host Computer Ethernet Adapters	1-15

2	Preparing for Operation	2-1
2-1.	Introduction	2-3
2-2.	Instrument Preparation	2-3
2-3.	Unpacking and Inspecting the Instrument	2-5
2-4.	Positioning and Rack Mounting	2-5
2-5.	Connecting to a Power Source and Grounding	2-5
2-6.	AC Power	2-6
2-7.	DC Power	2-7
2-8.	Grounding and Common Mode Voltage	2-7
2-9.	Universal Input Module Connections	2-7
2-10.	Shielded Wiring	2-11
2-11.	Crosstalk Considerations	2-11
2-12.	Digital I/O Connections	2-11
2-13.	Digital I/O	2-12
2-14.	Totalizer	2-12
2-15.	Alarm/Trigger I/O Connections	2-12
2-16.	Trigger Input	2-13
2-17.	Trigger Output	2-14
2-18.	Master Alarm	2-14
2-19.	External Trigger Wiring for a Group Instrument	2-15
2-20.	Controls and Indicators	2-15
2-21.	Front Panel Controls	2-17
2-22.	Front Panel Indicators	2-18
2-23.	Rear Panel Controls	2-20
2-24.	Rear Panel Indicators	2-20
2-25.	Front Panel Operating Procedures	2-21
2-26.	Power-On Options	2-21
2-27.	Displaying a Monitor Channel	2-22
2-28.	Displaying the Digital I/O Status	2-24
2-29.	Displaying the Totalizer Status	2-26
2-30.	Reviewing and Setting the Base Channel Number	2-27
2-31.	Reviewing and Setting the Line Frequency	2-29
2-32.	Reviewing and Setting the Network Type	2-31
2-33.	Reviewing and Setting the General Network Socket Port	2-36
2-34.	Reviewing and Setting the General Network IP Address	2-37
2-35.	Reviewing and Setting the Subnet Mask and Default Gateway..	2-38
2-36.	Viewing the Instrument Ethernet Address	2-41
2-37.	Host Computer and Network Preparation	2-43
2-38.	Installing Host Computer Ethernet Adapter	2-43
2-39.	Instrument and Host Computer Interconnection	2-45
2-40.	Host Computer/Instrument Direct Connection	2-45
2-41.	Interconnection Using 10Base2 (Coaxial) Wiring	2-48
2-42.	Interconnection Using 10BaseT (Twisted-Pair) Ethernet Wiring	2-48
2-43.	Installing Host Computer Networking Software	2-50

2-44.	Setting Host Computer Networking Parameters	2-51
2-45.	Installing NetDAQ Logger	2-52
2-46.	Installing NetDAQ Logger with Trumpet.....	2-53
2-47.	Changing from an Isolated Network to a General Network	2-54
2-48.	Installing Trend Link for Fluke (Optional)	2-55
2-49.	Testing and Troubleshooting.....	2-55
2-50.	Testing the Installation.....	2-55
2-51.	Troubleshooting Network Problems	2-58
3	Configuring NetDAQ Logger for Windows.....	3-1
3-1.	Introduction	3-3
3-2.	Starting NetDAQ Logger	3-3
3-3.	The Main Window	3-3
3-4.	Accessing NetDAQ Logger Commands	3-3
3-5.	Configuring Network Communications	3-4
3-6.	The Communications Configuration Dialog Box	3-5
3-7.	Adding an Instrument to the Network.....	3-5
3-8.	Deleting an Instrument from the Network	3-7
3-9.	Verifying Network Communications	3-7
3-10.	Configuring the Current Setup	3-8
3-11.	Creating an Instrument Icon.....	3-8
3-12.	Deleting an Instrument Icon.....	3-9
3-13.	Designating Instruments as Group or Asynchronous.....	3-9
3-14.	Setup Files	3-11
3-15.	Saving the Current Setup in a File	3-11
3-16.	Opening a Setup File.....	3-12
3-17.	Starting NetDAQ Logger with a Setup File	3-13
3-18.	Starting Logging Automatically.....	3-14
3-19.	NetDAQ Logger Command Line	3-14
3-20.	Configuring an Instrument.....	3-15
3-21.	Dimmed Configuration Commands	3-15
3-22.	The Instrument Configuration Dialog Box	3-15
3-23.	Configuring Channels.....	3-18
3-24.	The Channels Configuration Dialog Box.....	3-18
3-25.	Configuring Analog Channel Functions	3-19
3-26.	Configuring Computed Channel Functions	3-20
3-27.	Defining a Computed Channel Equation	3-20
3-28.	Equation Syntax	3-21
3-29.	Configuring Mx+B Scaling.....	3-22
3-30.	Configuring Alarms	3-23
3-31.	Assigning Channel Labels.....	3-24
3-32.	Configuring Mx+B Scaling From a File	3-24
3-33.	Entering an Instrument's Description.....	3-25
3-34.	Copying a Channels Configuration	3-26

3-35.	Default Configuration Settings	3-27
3-36.	Using Configuration Lockout	3-28
3-37.	Saving an Instrument's Configuration as a Text File.	3-28
3-38.	Configuring the netdaq.ini File	3-29
4	Operating NetDAQ Logger for Windows	4-1
4-1.	Introduction	4-3
4-2.	Starting and Stopping Logging	4-3
4-3.	Starting or Stopping all Instruments at Once.....	4-4
4-4.	Starting or Stopping a Group Instrument.....	4-4
4-5.	Clearing an Instrument's Totalizer Value	4-5
4-6.	Simulated Logging.....	4-5
4-7.	Selecting an Instrument's Scanning Duration	4-5
4-8.	Real-Time Displays.....	4-6
4-9.	The Logging Status Window	4-7
4-10.	The Readings Table Window	4-8
4-11.	The Spy Window	4-9
4-12.	Quick Plot	4-11
4-13.	Dynamic Data Exchange (DDE) Operations	4-12
4-14.	Data Files	4-13
4-15.	Configuring a Data File.....	4-14
4-16.	Converting Data Files	4-18
4-17.	Viewing and Printing a Data File	4-18
4-18.	Optimizing Performance	4-20
4-19.	Optimizing Performance for Speed	4-20
4-20.	Increasing Scanning Rate	4-20
4-21.	Increasing Data Transmission and Storage Rate.....	4-20
4-22.	Increasing Network Speed.....	4-21
4-23.	Optimizing Performance for Precision	4-21
4-24.	Using Online Help	4-21
5	Using Trend Link for Fluke.....	5-1
5-1.	Introduction.....	5-3
5-2.	Displaying a Trend Link Chart During Logging	5-3
5-3.	Playing Back a Trend Link File in Trend Link	5-4
5-4.	Playing Back a Fast Binary File in Trend Link	5-5
5-5.	Playing Back an ASCII (CSV) File in Trend Link.....	5-6
5-6.	Importing Trend Link Data Files.....	5-6
5-7.	Create a New Trend Link Data Set Directory	5-6
5-8.	Add the New Folder to the Trend Link infolink.ini File ...	5-6
5-9.	Import the NetDAQ ASCII (CSV) File into Trend Link	5-7
5-10.	Display the Trend Link Chart for the Imported File.	5-7
5-11.	Title the Trend Link Chart	5-8
5-12.	Save the Trend Link Chart	5-9

5-13.	Exporting Trend Link Data Files	5-9
5-14.	Deleting Old Trend Link Files	5-11
5-15.	Getting the Right Look for Your Trend Link Chart	5-12
5-16.	Using the Trend Link Control Bar	5-12
5-17.	Using the Trend Link Menus	5-15
5-18.	Adjusting the Curve Time Scale (X-axis)	5-15
5-19.	Adjusting the Curve Amplitude Scale (Y-axis)	5-16
5-20.	Configuring the Curve Status Display	5-17
5-21.	Curve Preferences	5-18
5-22.	Background Preferences	5-21
5-23.	Real Time Frequency Update	5-23
5-24.	Adding or Changing the Chart Title	5-23
5-25.	Using the Note System	5-24
5-26.	Printing a Chart	5-24
6	Maintenance	6-1
6-1.	Introduction	6-3
6-2.	Self-Test Diagnostics and Error Codes	6-3
6-3.	Cleaning	6-4
6-4.	Fuse Replacement	6-4
6-5.	Performance Test	6-6
6-6.	Configuring the Performance Test Setup	6-6
6-7.	Initializing the Performance Test Setup	6-9
6-8.	Accuracy Performance Tests	6-11
6-9.	Volts DC Accuracy Test (2640A)	6-11
6-10.	Volts DC Accuracy Test (2645A)	6-12
6-11.	Volts AC Accuracy Test	6-13
6-12.	Frequency Accuracy Test	6-14
6-13.	Analog Channel Integrity Test	6-15
6-14.	Computed Channel Integrity Test	6-15
6-15.	Thermocouple Temperature Accuracy Test	6-16
6-16.	Open Thermocouple Response Test	6-16
6-17.	2-Wire Resistance Accuracy Test (2640A)	6-17
6-18.	2-Wire Resistance Accuracy Test (2645A)	6-18
6-19.	4-Wire Resistance Accuracy Test (2640A)	6-20
6-20.	4-Wire Resistance Accuracy Test (2645A)	6-23
6-21.	RTD Temperature Accuracy Test (Resistance) (2640A)	6-24
6-22.	RTD Temperature Accuracy Test (Resistance) (2645A)	6-25
6-23.	RTD Temperature Accuracy Test (DIN/IEC 751 RTD)	6-25
6-24.	Digital Input/Output Tests	6-26
6-25.	Digital I/O Output Test	6-26
6-26.	Digital Input Test	6-27
6-27.	Totalizer Tests	6-28
6-28.	Totalizer Count Test	6-28

6-29.	Totalizer Sensitivity Test	6-28
6-30.	Master Alarm Output Test.....	6-29
6-31.	Trigger Input Test.....	6-30
6-32.	Trigger Output Test	6-30
6-33.	Calibration.....	6-31
6-34.	Adding Calibration to the Utilities Menu.....	6-32
6-35.	Instrument Calibration Dialog Box	6-33
6-36.	Calibration Steps Dialog Box	6-33
6-37.	Variations in the Display	6-34
6-38.	Service.....	6-34
6-39.	Replacement Parts.....	6-36

Appendices

A	Specifications	A-1
B	Noise, Shielding, and Crosstalk Considerations	B-1
C	True-RMS Measurements	C-1
D	RTD Linearization.....	D-1
E	Computed Channel Equations	E-1
F	Data File Format.....	F-1
G	Dynamic Data Exchange (DDE)	G-1
H	Ethernet Cabling.....	H-1
I	Network Considerations	I-1
J	Error Messages & Exception Conditions	J-1
K	Fluke Service Centers.....	K-1

Index

List of Tables

Table	Title	Page
1-1.	Models, Options and Accessories	1-14
2-1.	Front Panel Key Descriptions	2-17
2-2.	Annunciator Display Descriptions	2-18
2-3.	Instrument Default Parameters	2-21
2-4.	Network Error Messages	2-58
2-5.	Ethernet Indicators	2-60
2-6.	Troubleshooting	2-61
3-1.	NetDAQ Logger Default Instrument Configuration	3-27
6-1.	Self-Test Error Codes	6-3
6-2.	Recommended Test Equipment	6-7
6-3.	Replacement Parts	6-36
A-1.	2640A/2645A General Specifications	A-2
A-2.	2640A/2645A Environmental Specifications	A-4
A-3.	2640A/2645A DIGITAL I/O Specification	A-4
A-4.	2640A/2645A Trigger In (TI) Specification	A-5
A-5.	2640A/2645A Trigger Out (TO) Specification	A-6
A-6.	2640A/2645A Master Alarm (MA) Specification	A-6
A-7.	2640A/2645A Totalizer Specification	A-7
A-8.	2640A/2645A Real-Time Clock and Calendar	A-7
A-9.	2640A DC Voltage Measurement General Specifications	A-8
A-10.	2640A DC Voltage Range and Resolution Specifications	A-8
A-11.	2640A DC Voltage Accuracy Specifications	A-9
A-12.	2640A AC Voltage General Specifications	A-9
A-13.	2640A AC Voltage Range and Resolution Specifications	A-10
A-14.	2640A AC Voltage Accuracy Specifications	A-11
A-15.	2640A 4-Wire Resistance Temperature Coefficient	A-12
A-16.	2640A 4-Wire Resistance Range and Resolution Specifications	A-12
A-17.	2640A 4-Wire Resistance Accuracy Specifications	A-12
A-18.	2640A 4-Wire RTD Temperature Coefficient	A-13
A-19.	2640A 4-Wire RTD Specifications	A-13
A-20.	2640A Thermocouple General Specifications	A-14

A-21.	2640A Thermocouple Specifications	A-15
A-22.	2640A Frequency Accuracy Specifications.....	A-16
A-23.	2640A Frequency Sensitivity Specifications.....	A-16
A-24.	2645A DC Voltage Measurement General Specifications	A-17
A-25.	2645A DC Voltage Resolution and Repeatability Specifications	A-18
A-26.	2645A DC Voltage Accuracy Specifications	A-18
A-27.	2645A AC Voltage General Specifications.....	A-19
A-28.	2645A AC Voltage Range and Resolution Specifications	A-20
A-29.	2645A AC Voltage Accuracy Specifications	A-20
A-30.	2645A 4-Wire Resistance Temperature Coefficient.....	A-21
A-31.	2645A 4-Wire Resistance Range and Resolution Specifications	A-21
A-32.	2645A 4-Wire Resistance Accuracy Specifications	A-21
A-33.	2645A 4-Wire RTD Temperature Coefficient.....	A-22
A-34.	2645A 4-Wire RTD Specifications.....	A-22
A-35.	2645A Thermocouple General Specifications.....	A-23
A-36.	2645A Thermocouple Specifications	A-23
A-37.	2645A Frequency Accuracy Specifications.....	A-25
A-38.	2645A Frequency Sensitivity Specifications.....	A-25
B-1.	2645A Crosstalk Specifications.....	B-3
B-2.	2640A Crosstalk Specifications.....	B-4
I-1.	Newt Quick Check.....	I-29
I-2.	Additions to Host Computer Files made by Newt Installation	I-30

List of Figures

Figure	Title	Page
1-1.	2640A/2645A NetDAQ Networked Data Acquisition Units	1-3
1-2.	2640A/2645A Front Panel	1-4
1-3.	Typical Front Panel Display During Scanning and Monitoring	1-5
1-4.	2640A/2645A Rear Panel.....	1-6
2-1.	Instrument Preparation	2-4
2-2.	Connecting the Instrument to a Power Source	2-6
2-3.	Universal Input Module Connections	2-9
2-4.	2-Wire and 4-Wire Connections.....	2-10
2-5.	DIGITAL I/O Connector	2-12
2-6.	ALARM/TRIGGER I/O Connector	2-14
2-7.	External Trigger Wiring for a Group Instrument	2-16
2-8.	Front Panel Controls.....	2-17
2-9.	Front Panel Indicators	2-18
2-10.	Rear Panel Controls.....	2-20
2-11.	Rear Panel Indicators	2-20
2-12.	Displaying a Monitor Channel	2-22
2-13.	Examples During Monitor.....	2-23
2-14.	Displaying the Digital I/O Status	2-24
2-15.	Examples for Digital I/O and Totalizer Status	2-25
2-16.	Displaying the Totalizer Status	2-26
2-17.	Reviewing and Setting the Base Channel Number	2-27
2-18.	Examples for Reviewing and Setting the BCN	2-28
2-19.	Reviewing and Setting the Line Frequency	2-29
2-20.	Examples for Reviewing and Setting the Line Frequency	2-30
2-21.	Reviewing and Setting the Isolated Network Type to Isolated	2-31
2-22.	Examples for Reviewing and Setting the Network Type	2-32
2-23.	Reviewing and Setting the Network Type to General.....	2-33
2-24.	Examples for Reviewing and Setting General Network Parameters.....	2-34
2-25.	Reviewing and Setting the General Network Socket Port	2-36
2-26.	Reviewing and Setting the General Network IP Address	2-37
2-27.	Reviewing and Setting the Subnet Mask and Default Gateway.....	2-40

2-28.	Viewing the Instrument Ethernet Address.....	2-41
2-29.	Examples for Viewing the Ethernet Address.....	2-42
2-30.	Preparing for Network Operation	2-44
2-31.	Interconnection Using 10Base2 (Coaxial) Wiring.....	2-46
2-32.	Host Computer/Instrument Direct Connection	2-47
2-33.	Interconnection Using 10BaseT (Twisted-Pair) Wiring.....	2-49
3-1.	NetDAQ Logger for Windows Main Window	3-4
3-2.	Communications Configuration Dialog Box	3-5
3-3.	Instrument Configuration Dialog Box	3-16
3-4.	Channels Configuration Dialog Box.....	3-18
3-5.	Configuration Text File	3-29
6-1.	Replacing the Fuse.....	6-5
6-2.	Performance Test Setup.....	6-8
6-3.	2-Wire Connections to 5700A	6-8
6-4.	4-Wire Connections to the Universal Input Module (Resistor).....	6-20
6-5.	4-Wire Connections to the Universal Input Module (5700A)	6-21
C-1.	Comparison of Common Waveforms	C-3
D-1.	385 RTD	D-2
D-2.	375 RTD	D-3
D-3.	391 RTD	D-4
D-4.	392 RTD	D-6
H-1.	10BaseT Ethernet Cables.....	H-2

Chapter 1 Overview

	Contents	Page
1-1.	Introduction	1-3
1-2.	Instrument Features and Capabilities	1-4
1-3.	Analog Channels	1-7
1-4.	Computed Channels	1-7
1-5.	Channel Numbering	1-7
1-6.	Mx+B Scaling	1-7
1-7.	Alarms	1-8
1-8.	Channel Monitoring	1-8
1-9.	Digital I/O	1-8
1-10.	Totalizer	1-8
1-11.	Trigger Input	1-9
1-12.	Trigger Output.....	1-9
1-13.	Master Alarm	1-10
1-14.	Interval Trigger	1-10
1-15.	External Trigger	1-10
1-16.	Alarm Trigger	1-10
1-17.	NetDAQ Logger Features and Capabilities.....	1-11
1-18.	Operating a NetDAQ Data Acquisition System.....	1-11
1-19.	Isolated Networks	1-12
1-20.	General Networks	1-12
1-21.	Ethernet Port Selection	1-12
1-22.	Asynchronous Instrument Operations.....	1-12
1-23.	Group Instrument Operations.....	1-12
1-24.	Scanning and Logging.....	1-13
1-25.	RS-232 Interface	1-13
1-26.	Host Computer Requirements	1-14
1-27.	Options and Accessories	1-14
1-28.	Instrument Connector Set.....	1-15
1-29.	Host Computer Ethernet Adapters	1-15

Introduction

1-1.

The 2640A and 2645A NetDAQ® Networked Data Acquisition Units are 20-channel front ends that operate in conjunction with NetDAQ Logger for Windows (hereafter known as NetDAQ Logger) to form a data acquisition system.

The instruments measure dc volts, ac volts, Ohms, temperature, frequency, and dc current. Temperature measurements use thermocouples or resistance-temperature detectors (RTDs). To measure other parameters, use an appropriate transducer. The instrument also includes ten computed channels for custom calculations based on measured values.

The NetDAQ instruments scan the 20 analog channels in sequence and calculate the values for the ten computed channels. Interval timers, alarm conditions, and/or an external signal input can trigger scans. The NetDAQ Logger software configures and controls up to 20 instruments via an Ethernet connection. The software provides the means to view scan data and log it into files.

The 2640A and 2645A instruments (Figure 1-1) are identical in operation and appearance, and vary only in emphasis. The 2640A emphasizes precision and supports up to 100 measurements per second, with 5 ½ digits of resolution, .02% accuracy, and 150-volt common mode voltage (300 volts on channels 1 and 11). The 2645A emphasizes increased measurement speed supporting up to 1000 measurements per second, with 4 ½ digits of resolution, 0.04% accuracy, and 50-volt common mode voltage. See Appendix A for instrument specifications.

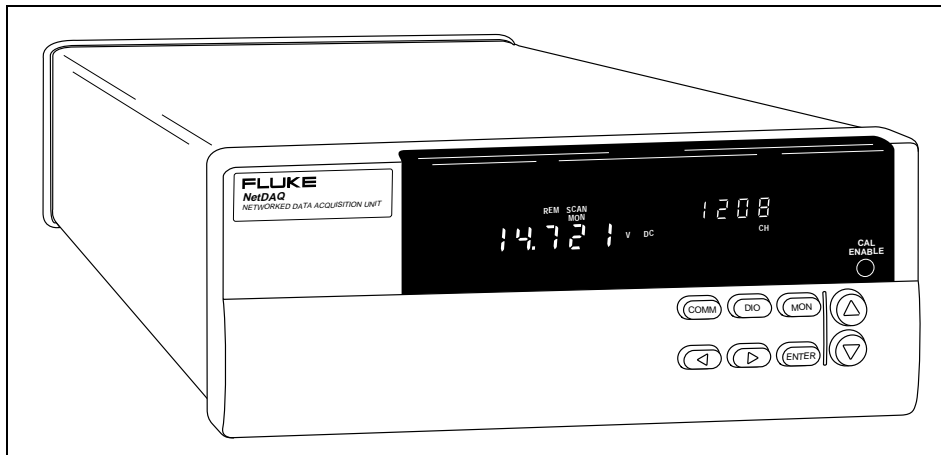

Figure 1-1. 2640A/2645A NetDAQ Networked Data Acquisition Units

Instrument Features and Capabilities

1-2.

The following describes the front and rear panels of the instrument and its capabilities (Figures 1-2 to 1-4).

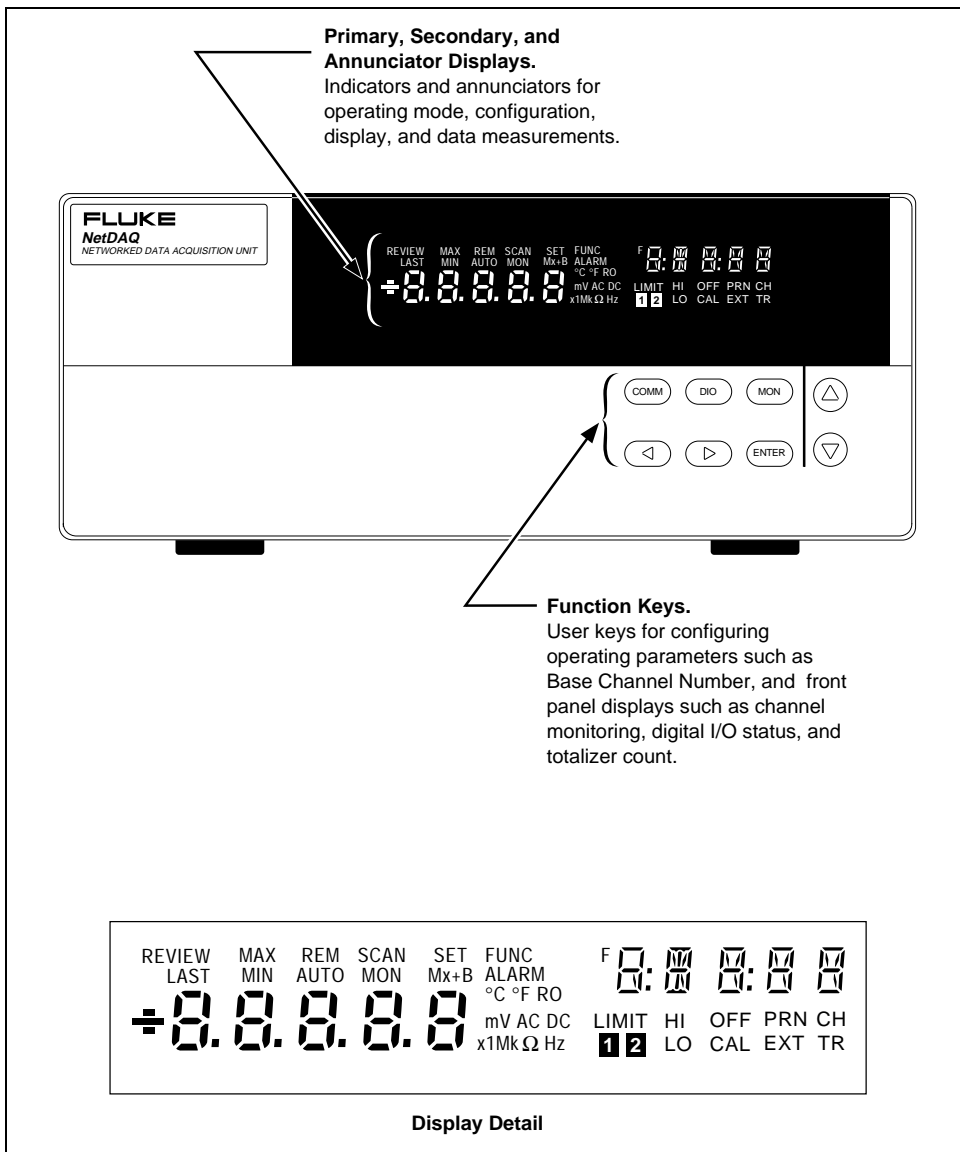

Figure 1-2. 2640A/2645A Front Panel

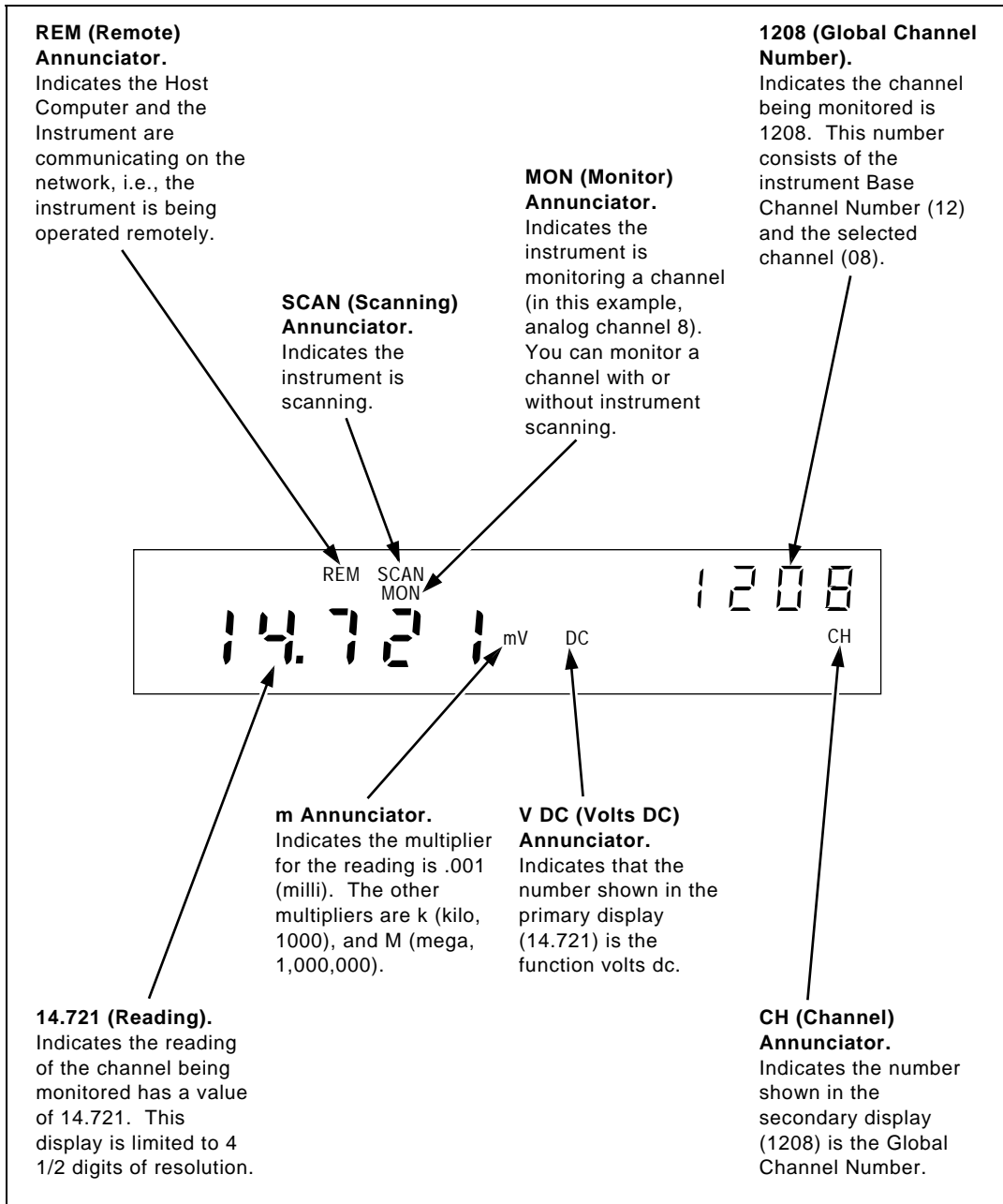

Figure 1-3. Typical Front Panel Display During Scanning and Monitoring

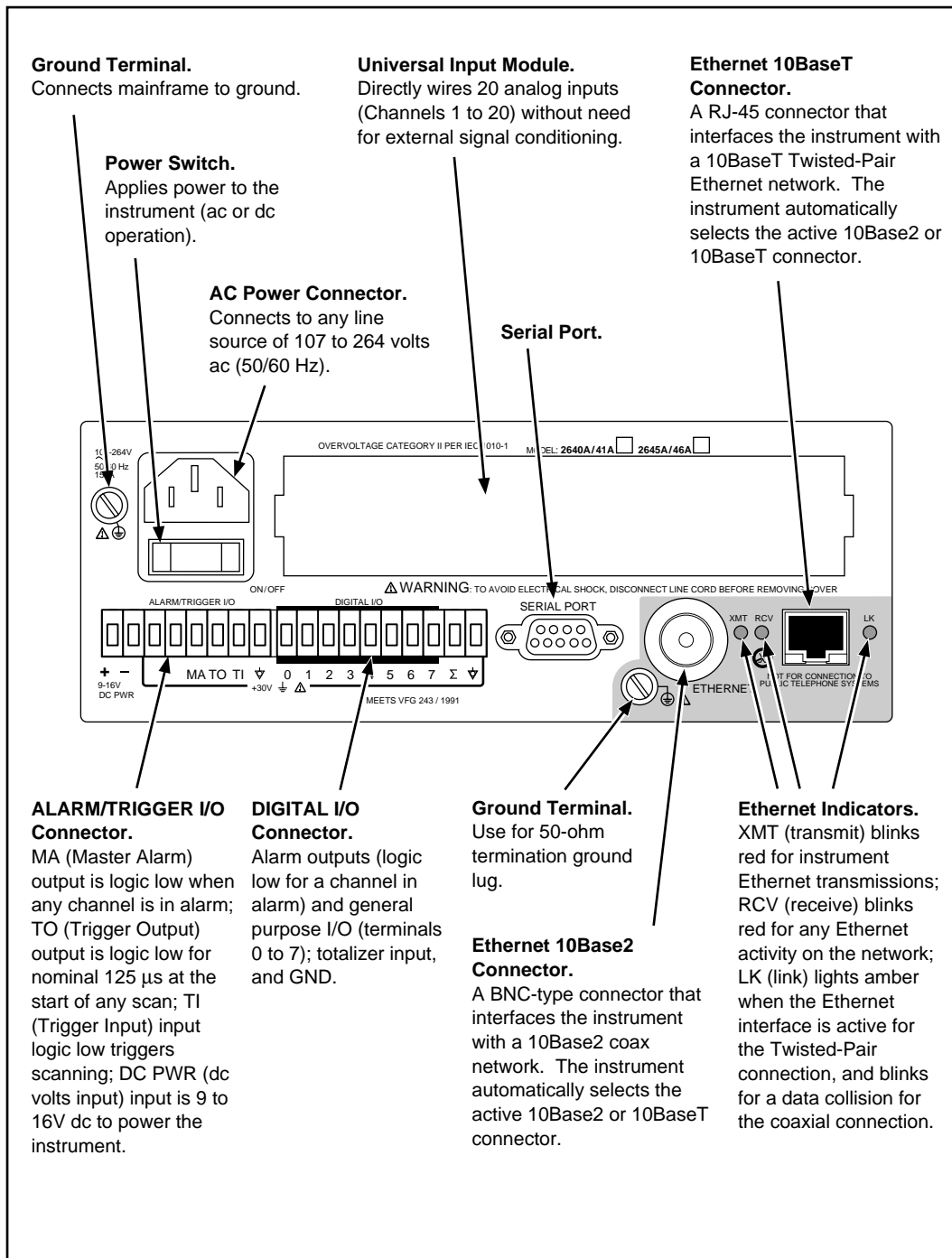

Figure 1-4. 2640A/2645A Rear Panel

Analog Channels

1-3.

The analog channel (1 to 20) measurement connections are made via the Universal Input Module. External signal conditioning for the analog inputs is not necessary. The host computer configures all analog channels using NetDAQ Logger.

Computed Channels

1-4.

In addition to the 20 analog channels, the instrument provides an additional 10 computed channels (21 to 30) by processing analog channels and other computed channels. The following methods are used:

- The average of a group of channels,
- The difference between any two channels,
- The difference between a channel and the average of a group of channels,
- A mathematical equation.

Channel Numbering

1-5.

Each instrument channel, measured or computed, is identified by Global Channel Number (GCN). The first two digits of the GCN are the Base Channel Number (01 to 99) that identifies the instrument. The last two digits are the channel number. For example, GCN 2618 indicates instrument 26 and analog channel 18 (below). When the instrument is in the quiescent state, the channel number of the GCN shows dashes, for example, 45-- for instrument 45.

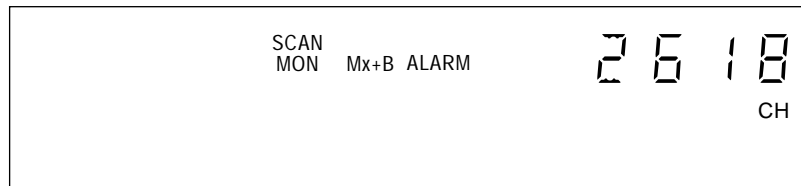

Mx+B Scaling

1-6.

Mx+B scaling multiplies a measurement by a multiplier M and then offsets it by an offset B. For example, Mx+B scaling of $100x+50$ applied to a measured or computed channel value of 1.15 results in a reading of $100(1.15)+50=165$. A common use of Mx+B scaling is to calibrate a sensor or transducer to provide for display and recording in engineering units. The Mx+B annunciator lights when a monitored channel has scaling applied.

Alarms

1-7.

Two alarms, Alarm 1 and Alarm 2, can be applied to any configured channel. An alarm condition occurs when a measurement falls below a low alarm value or rises above a high alarm value. You can use alarms to trigger scanning (see “Alarm Triggering”) and to set a Digital I/O line to a logic low (see “Digital I/O” below). NetDAQ Logger displays and records alarm conditions.

If you apply Mx+B scaling as part of the channel configuration, the instrument bases the alarms on the scaled values. When any configured channel is in alarm, the ALARM annunciator is on dim, or bright if a channel in alarm is being used as an Alarm Trigger. When a channel is in alarm, the rear-panel Master Alarm output is asserted (logic low). NetDAQ Logger displays and records alarm conditions.

Channel Monitoring

1-8.

Channel monitoring takes place at the front panel of the instrument. Use the front panel MON key and arrow keys to select a channel for monitoring. NetDAQ Logger also allows the selection of a channel to monitor during scanning. For an example of a front panel display of the instrument during monitoring, see Figure 1-3. The channel monitoring display updates once per second (nominal).

Digital I/O

1-9.

Eight general-purpose open-collector Transistor-Transistor Logic (TTL) digital input/output (I/O) lines are available at the instrument rear-panel DIGITAL I/O connector, terminals 7 through 0 (Figure 1-4). A logic low externally applied to an I/O line is an input; a logic low internally set by the instrument is an output. An output logic low condition takes precedence over an input logic high condition. When the I/O lines are used as inputs, they signal an external condition that can be correlated to the data measurements.

NetDAQ Logger displays and records the status of the Digital I/O as the decimal equivalent of the eight binary bits. For example, 11111111 (DIO7 to DIO0) is represented by decimal 255; 00001111 is represented by decimal 15.

The instrument can display the Digital I/O status in binary format at the front panel with updates each second.

Totalizer

1-10.

The totalizer input counts contact closures or voltage transitions with a maximum count of 4,294,967,295. The connections for the totalizer input line are at the instrument rear panel DIGITAL I/O connector, terminals Σ and GND (Figure 1-4). The instrument continuously detects the totalizer input on the rear panel independently from instrument scanning and other activities. If the Totalizer

overflows (reaching the maximum count), the display briefly shows OL (overload) and begins counting from zero again

A totalizer input from contact closures increments on the “open” portion of the switch sequence close-open. To prevent switch contact “bounce” from triggering false readings, select the Totalizer Debounce feature. A totalizer input from voltage transitions increments during low-to-high voltage transitions with a nominal threshold of +1.4 volts. The maximum voltage input is +30V dc, and the minimum voltage input is -4.0V dc. The maximum totalizer rate is 5,000 transitions per second without debounce and 500 transitions per second with debounce.

The instrument reports Totalizer status with scan data and can display it at the front panel. You can clear the Totalizer count by cycling power to the instrument or via NetDAQ Logger.

Trigger Input

1-11.

Trigger Input is an instrument connection used to trigger scans from an external source. The connection uses the ALARM/TRIGGER I/O terminals TI and GND (Figure 1-4). A contact closure or logic low between TI and GND triggers an instrument scan if External Trigger is enabled. While the trigger input line is held low, the instrument continues to scan at Interval 2.

When there is no trigger input, an internal pull-up resistor holds the input at logic high (nominal +5.0V dc).

Trigger Output

1-12.

Trigger Output is an output line that, when enabled, goes to logic low for 125 μ s every time a scan begins. The connection uses the ALARM/TRIGGER I/O terminals TO and GND (Figure 1-4). Use the Trigger Output to trigger other instruments by their Trigger Input connection and to interface with external equipment. An internal pull-up resistor holds the trigger output line at a logic high (nominal +5.0V dc) when there is no trigger output.

Master Alarm**1-13.**

Master Alarm is an instrument output line that is logic low (nominal +0.8V dc) for as long as any channel is in alarm while scanning is active. The connection uses the ALARM/TRIGGER I/O terminals MA and GND (Figure 1-4). This TTL output interfaces with external equipment such as warning lights, alarms, automatic shutdowns, and paging systems. When the alarm condition ends or scanning stops, an internal pull-up resistor sets the output at logic high (nominal +5.0V dc).

Interval Trigger**1-14.**

Interval Trigger triggers scanning at regular time intervals using Interval 1. Interval 1 is in seconds, with a minimum of 0.000 (continuous scanning) and a maximum of 86400.000 (one scan every 24 hours). The time resolution is to the millisecond, for example, 12.345 seconds.

External Trigger**1-15.**

External Trigger triggers scanning when an external logic low is applied to the instrument TI (Trigger In) line. As long as the Trigger Input remains low, scans are triggered at regular time intervals using Interval 2. Interval 2 is in seconds, with a minimum of 0.000 (continuous scanning) and a maximum of 86400.000 (one scan every 24 hours). The time resolution is to the millisecond, for example, 12.345 seconds. When scanning starts, if the External Trigger is logic low, scanning begins at the Interval 2 rate. If the External Trigger is logic high, no scans are triggered until the trigger line is set to logic low.

You can combine External Trigger with Alarm Trigger and Interval Trigger. For example, if the Interval Trigger is set for 60 seconds (Interval 1) and the External Trigger is set for 10 seconds (Interval 2), scanning is at 60-second intervals except when External Trigger is low, when scanning is at 10-second intervals.

If one or more external trigger events occur while a scan is in progress, one scan triggers following the scan in progress.

Alarm Trigger**1-16.**

Alarm Trigger triggers scanning when a channel designated as an alarm trigger goes into alarm. As long as any such channel is in alarm, scans are triggered at regular time intervals using Interval 2. Interval 2 is in seconds, with a minimum of 0.000 (continuous scanning) and a maximum of 86400.000 (one scan every 24 hours). The time resolution is to the millisecond, for example, 12.345 seconds.

The instrument performs background monitoring of channels designated as alarm triggers to check for alarm conditions using Interval 3. (See “Configuring the netdaq.ini File” in Chapter 3 of this manual.)

You can combine Alarm Trigger with External Trigger and Interval Trigger. For example, set the Interval Trigger for 60 seconds (Interval 1) and the Alarm Trigger for 10 seconds (Interval 2). Scanning is at 60-second intervals except when a channel designated as an alarm trigger is in alarm, when scanning is at 10-second intervals.

NetDAQ Logger Features and Capabilities

1-17.

NetDAQ Logger is the operating software for NetDAQ instruments. It lets you configure and operate your system through a Windows-based environment. The package installs either a 32-bit version for Windows 95 and Windows NT, or a 16-bit version for Windows 3.1. Chapters 3 and 4 of this manual provide an overview of operating NetDAQ Logger. Online help provides more details.

Some major features of NetDAQ Logger include:

- **Multiple Instruments.** NetDAQ Logger lets you configure and control up to 20 instruments either as Asynchronous instruments or a Group Instrument.
- **Data File Recording.** NetDAQ Logger logs scan data into a choice of several file types for each instrument or instrument group.
- **Online Help.** Online help describes the controls and operations.
- **Real-time Data Display.** The Readings Table displays the latest scan data from the currently selected instrument. Quick Plot graphs scan data from any eight channels. The Spy utility gets current readings from any eight channels whether or not scanning is active.
- **Real-Time Trend Plotting.** Trend Link for Fluke (optional) lets you view real-time or historical trends in your collected data. It compares data from multiple sources, performs simple Statistical Process Control (SPC) calculations on selected data portions, annotates data, highlights curve limits, zooms in on data of interest, compares batches, and exports to spreadsheets or other applications.
- **Dynamic Data Exchange (DDE).** You can link data to other Windows-based applications, such as spreadsheets, with Dynamic Data Exchange (DDE).

Operating a NetDAQ Data Acquisition System

1-18.

You can configure NetDAQ hardware and software to operate over either an isolated or general network. An isolated network includes NetDAQ instruments and host computers only. A general network may also include servers, routers, gateways, or other network devices. Both types of networks interconnect using Ethernet (i.e., using the IEEE 802.3 or ISO 8802-3 standards).

A unique 2-digit Base Channel Number (BCN) entered at the instrument front panel identifies each NetDAQ instrument on the network. All subsequent

operations refer to the instrument by BCN. NetDAQ Logger supports up to 20 instruments for operation. You cannot operate an instrument from more than one host computer at a time.

Isolated Networks**1-19.**

An isolated network consists of only NetDAQ instruments and host computers. The advantages include simplified setup, faster network operation, and freedom from general network problems. Data throughput specifications are guaranteed only for isolated networks. When you install NetDAQ Logger for an isolated network, it automatically handles instrument IP addressing. You must configure your host computer networking software to use a host computer IP address of 198.178.246.1xx and subnet mask of 255.255.255.0. See “Setting Host Computer Network Parameters” in Chapter 2 of this manual.

General Networks**1-20.**

A general network consists of host computers, NetDAQ instruments, and servers, routers, gateways, or other network devices. Refer connectivity issues to your network administrator and review Appendix I “Network Considerations” for more information. When you install the NetDAQ software for a general network, you must enter the instrument IP addresses manually.

Ethernet Port Selection**1-21.**

Each instrument has two network ports: 10Base2 coaxial and 10BaseT twisted pair Ethernet. The instrument automatically monitors and selects the active Ethernet port. You may change ports at any time and the instrument will detect the change and automatically connect to the active port.

Asynchronous Instrument Operations**1-22.**

Using NetDAQ Logger, you denote instruments as asynchronous or grouped. An asynchronous (independent) instrument controls its own scanning operations, including scan interval and method of triggering scans. NetDAQ Logger records measurement data from each asynchronous instrument in an individual data file.

Group Instrument Operations**1-23.**

Using NetDAQ Logger, you can group multiple instruments to act as one instrument. NetDAQ Logger records data from all instruments in the group into a single data file. You can group up to 20 instruments for up to 400 time-correlated channels.

Designate one instrument in the group as the Master and the others as Slaves. The Master controls scanning operations, including the scan intervals and method of scan triggering. You can create only one group instrument.

Scanning and Logging

1-24.

When a scan is triggered, the instrument scans the 20 analog channels and calculates the 10 computed channels. It stores the resulting time-stamped data in a scan record. Scans can be triggered from several sources:

- Interval Trigger, where an elapsed interval timer triggers a scan.
- External Trigger, where an external input (ground or logic low) applied to the instrument TI (Trigger In) line triggers a scan.
- Alarm Trigger, where a channel going into alarm status a scan.

NetDAQ Logger obtains scan records from the instruments and logs the data into files. Each scan record written in the data file consists of a timestamp, values from all configured analog channels and computed channels, the alarm states, the digital I/O line status, and the count of the totalizer.

RS-232 Interface

1-25.

The instruments include an RS-232 port for calibration and factory procedures; the RS-232 port is not used for instrument control or scan data collection. The NetDAQ Service Manual (PN 942615) describes calibration and factory procedures that use the RS-232 port. See also “Calibration” in Chapter 6 of this manual.

Host Computer Requirements

1-26.

The host computer used for instrument operations must meet the following minimum requirements:

- IBM PC with an Intel 386 microprocessor or greater, running Windows 95, Windows NT, or Windows 3.1.
- Color VGA Monitor.
- A Hard disk drive with 2 MB of free disk space.
- A 1.44 Mbyte (3 1/2-inch) floppy disk drive.

Options and Accessories

1-27.

Table 1-1 summarizes the available Models, Options and Accessories, including measurement transducers, software, connector sets, Ethernet adapters, cables, and components.

Table 1-1. Models, Options and Accessories

Model	Description
2640A	NetDAQ Networked Data Acquisition Unit
2645A	NetDAQ Networked Data Acquisition Unit
2640A-911	NetDAQ Logger for Windows
2640A-912	NetDAQ Logger with Trending
264XA-903	NetDAQ Developer's Toolbox
2600A-904	Trend Link for Fluke
264XA-801	Ethernet Card (10Base2, 10BaseT)
264XA-802	Parallel-to-LAN Adapter (10Base2)
264XA-803	PCMCIA Adapter (10Base2, 10BaseT)
2640A-913	Newt Networking Software
2620A-100	Input Module Option
2620A-101	4-20 mA Current Shunt Strip
942615	NetDAQ <i>Service Manual</i>
Y2641	19" Rackmount Kit Single/Dual
Y2642	Wall/Cabinet Mounting Plate
Y2643	4-meter Cable Kit
Y2644	NEMA 4X (IP65) Enclosure

Instrument Connector Set

1-28.

The 2620A-100 is a complete set of input connectors: one Universal Input Module, one ALARM/TRIGGER I/O connector, and one DIGITAL I/O connector. A 2620A-100 Instrument Connector Set comes with each instrument. You can wire additional connector sets to allow quick interfacing to multiple wiring setups.

Host Computer Ethernet Adapters

1-29.

The 264XA-801, 264XA-802, and 264XA-803 are the recommended Ethernet adapters. The 264XA-801 is a plug-in card, the 264XA-802 is an external parallel-to-LAN adapter, and the 264XA-803 is a PCMCIA card.

Chapter 2

Preparing for Operation

Contents	Page
2-1. Introduction	2-3
2-2. Instrument Preparation	2-3
2-3. Unpacking and Inspecting the Instrument.....	2-5
2-4. Positioning and Rack Mounting.....	2-5
2-5. Connecting to a Power Source and Grounding.....	2-5
2-6. AC Power.....	2-6
2-7. DC Power.....	2-7
2-8. Grounding and Common Mode Voltage.....	2-7
2-9. Universal Input Module Connections	2-7
2-10. Shielded Wiring.....	2-11
2-11. Crosstalk Considerations	2-11
2-12. Digital I/O Connections	2-11
2-13. Digital I/O	2-12
2-14. Totalizer	2-12
2-15. Alarm/Trigger I/O Connections	2-12
2-16. Trigger Input	2-13
2-17. Trigger Output	2-14
2-18. Master Alarm	2-14
2-19. External Trigger Wiring for a Group Instrument.....	2-15
2-20. Controls and Indicators	2-15
2-21. Front Panel Controls.....	2-17
2-22. Front Panel Indicators.....	2-18
2-23. Rear Panel Controls	2-20
2-24. Rear Panel Indicators	2-20
2-25. Front Panel Operating Procedures	2-21
2-26. Power-On Options	2-21
2-27. Displaying a Monitor Channel.....	2-22
2-28. Displaying the Digital I/O Status.....	2-24

2-29.	Displaying the Totalizer Status	2-26
2-30.	Reviewing and Setting the Base Channel Number	2-27
2-31.	Reviewing and Setting the Line Frequency	2-29
2-32.	Reviewing and Setting the Network Type	2-31
2-33.	Reviewing and Setting the General Network Socket Port	2-36
2-34.	Reviewing and Setting the General Network IP Address	2-37
2-35.	Reviewing and Setting the Subnet Mask and Default Gateway..	2-38
2-36.	Viewing the Instrument Ethernet Address	2-41
2-37.	Host Computer and Network Preparation	2-43
2-38.	Installing Host Computer Ethernet Adapter	2-43
2-39.	Instrument and Host Computer Interconnection.....	2-45
2-40.	Host Computer/Instrument Direct Connection	2-45
2-41.	Interconnection Using 10Base2 (Coaxial) Wiring	2-48
2-42.	Interconnection Using 10BaseT (Twisted-Pair) Ethernet Wiring	2-48
2-43.	Installing Host Computer Networking Software	2-50
2-44.	Setting Host Computer Networking Parameters.....	2-51
2-45.	Installing NetDAQ Logger	2-52
2-46.	Installing NetDAQ Logger with Trumpet	2-53
2-47.	Changing from an Isolated Network to a General Network.....	2-54
2-48.	Installing Trend Link for Fluke (Optional).....	2-55
2-49.	Testing and Troubleshooting	2-55
2-50.	Testing the Installation	2-55
2-51.	Troubleshooting Network Problems.....	2-58

Introduction

2-1.

This chapter describes how to prepare the instruments, host computers and network for operation, and how to test and troubleshoot system operation.

Setting up your system requires the following steps (described in detail later in this chapter), performed in the order shown:

- **Instrument Preparation** Unpacking and setting up the NetDAQ instrument. This section of the manual describes all the connections, controls, and indicators on the instrument.
- **Host Computer Ethernet Adapter Installation** Installing an Ethernet adapter such as the 264XA-801, 264XA-802, or 264XA-803 if your host computer does not already have one.
- **Instrument and Host Computer Interconnection** Connecting the host computer(s) and instruments.
- **Host Computer Software Installation** Installing NetDAQ Logger for Windows and networking software.
- **Trend Link Installation** (Optional) Installing Trend Link software on your host computer.
- **Testing and Troubleshooting** Testing and verifying network operation, and troubleshooting any difficulties.

Instrument Preparation

2-2.

This section contains information for preparing the instruments for operation summarized in Figure 2-1.

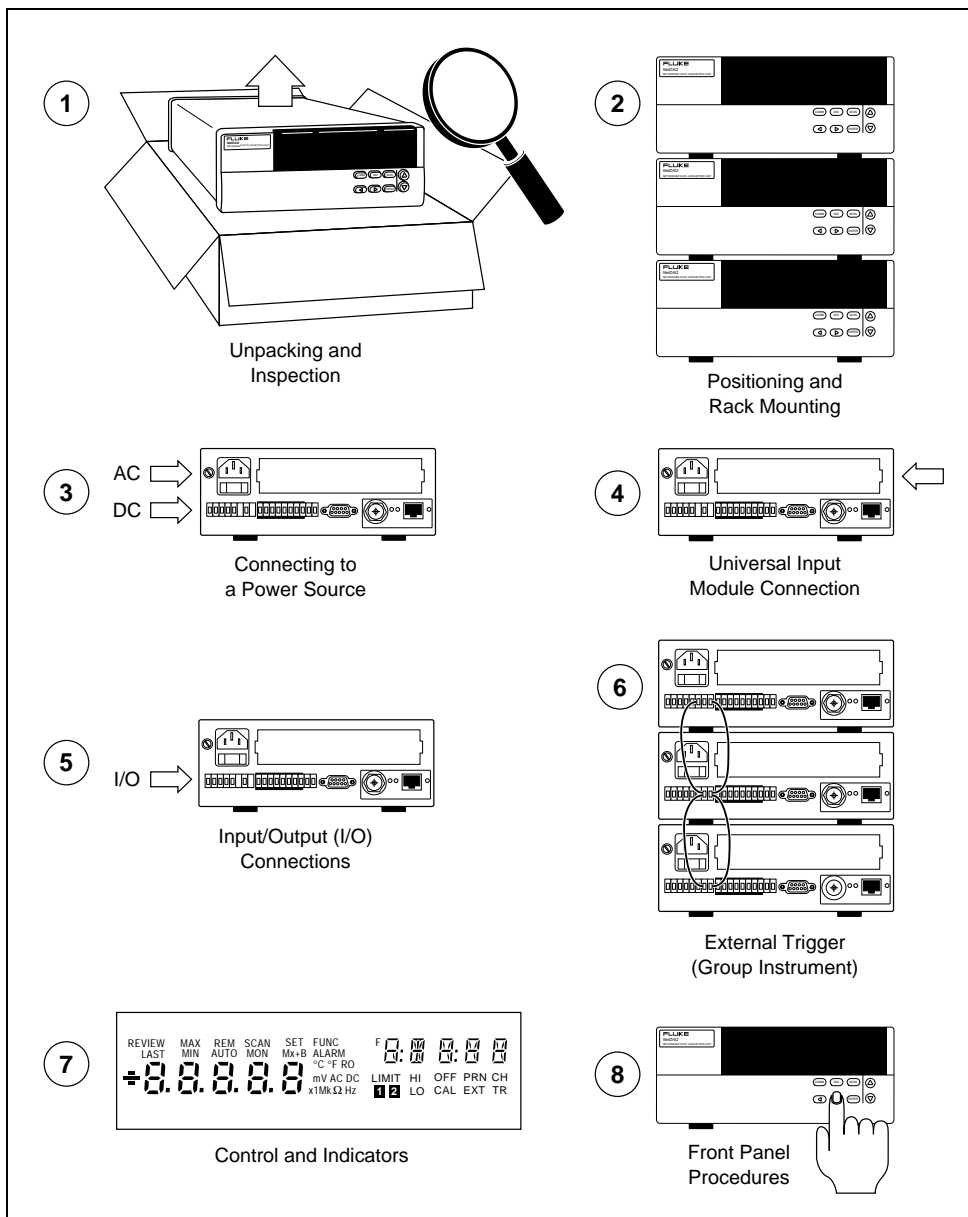

Figure 2-1. Instrument Preparation

Unpacking and Inspecting the Instrument **2-3.**

Verify the contents of the shipping package against the checklist in the package. If any items are missing or damaged, report the problem immediately to your Fluke representative.

Carefully remove the instrument from its shipping container, saving the packaging materials if possible. Inspect the rear rubber feet of the instrument. If they are flush with the bottom of the case, then rotate them 180 degrees so that their support pads extend slightly below the bottom of the case.

Positioning and Rack Mounting **2-4.**

Position the instrument in any location that meets the environmental specifications. (Refer to Appendix A.) The Y2641 Rack Mounting Kit includes hardware and instructions to mount one or two instruments (see "Options and Accessories" in Chapter 1).

Connecting to a Power Source and Grounding **2-5.**

You can connect the instrument to an ac power source between 107 to 264V ac (45 to 65 Hz), to a dc power source between 9 and 16V dc, or to both. Fluke guarantees equipment specifications only for 50 Hz and 60 Hz operation. Refer to Figure 2-2 and the descriptions below for making power connections. If you connect both ac power and dc power to the instrument, the instrument uses ac power when it exceeds approximately 8 times the value of the dc voltage. Automatic switchover occurs between ac and dc power without interrupting instrument operation.

If you connect both ac and dc power to the instrument, the ac and dc ground connections must be to the same earth ground terminal.

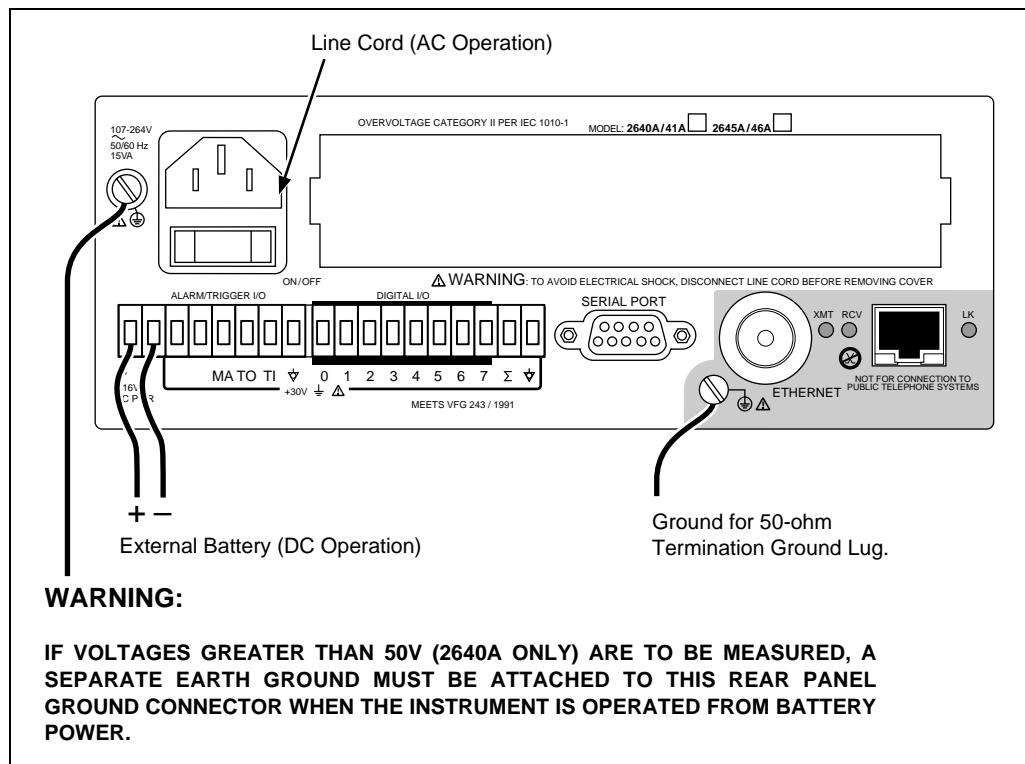

Figure 2-2. Connecting the Instrument to a Power Source

⚠ Warning

To avoid shock hazard when powering the instrument with ac power, connect the power cord to a receptacle with an earth ground.

AC Power

2-6.

Plug the line cord into the connector on the rear of the instrument as shown in Figure 2-2. The instrument operates on any line voltage between 107 and 264V ac (45 to 65 Hz) without adjustment. Fluke warrants the instrument to meet specifications only at 50 Hz and 60 Hz operation. Power consumption is a nominal 15 watts. Be sure the line cord ground terminal connects to an earth ground.

⚠ Warning

To avoid shock hazard when powering the instrument with dc power, connect the instrument ground terminal to an earth ground.

DC Power

2-7.

The instrument operates from any dc voltage between 9 and 16 volts. Power consumption is a nominal 6 watts. To connect the ALARM/TRIGGER I/O connector to the rear panel, complete the following procedure:

1. Remove the ALARM/TRIGGER I/O connector from the packing material or instrument rear panel.
2. Loosen the wire clamp screw for the associated terminal.
3. Feed the wire into the gap between the connector body and the wire clamp.
4. Tighten the wire clamp; do not overtighten and crush the wire.
5. Repeat steps 2 through 4 for each wire.
6. Insert the connector in the rear panel.

Grounding and Common Mode Voltage

2-8.

Connect the instrument chassis to a good earth ground (Figure 2-2) to prevent a common mode voltage from gradually raising the chassis to a high potential. For example, if you measure the voltage across a resistor in a 50V dc circuit, the instrument reads the resistor voltage and ignores the 50V dc common mode voltage. Since the impedance between the channel's inputs and chassis ground is not infinite, a common mode voltage gradually leaks to the chassis ground. A good earth ground prevents the chassis from rising to the common-mode voltage (50V dc in this case).

Universal Input Module Connections

2-9.

Connections to the Universal Input Module (Figure 2-3) use the H (high) and L (low) pairs of terminals for each of the 20 analog input channels. Complete the following procedure to make connections.

Warning

To avoid electric shock, remove all inputs from live voltages before opening this module. Input wiring may be connected to live voltages.

1. Remove the module from the rear panel by pressing the release tab on the bottom of the module and pulling the module free of the connector.
2. Loosen the two large screws on top and open the module.
3. Connect the wires to H (high/positive) and L (low/negative) for each channel.
4. Thread these wires through the strain-relief pins and out the back of the module.

5. Close the module cover, secure the screws, and insert the module in the connector at the rear of the instrument until it latches in place.

Resistance and RTD measurements use two terminals (one channel) or four terminals (two channels). The 4-wire connection provides increased accuracy over the 2-wire connection. Refer to Figure 2-5 for examples of 2-wire and 4-wire connections. (The 2645A does not allow two-wire RTD measurements.)

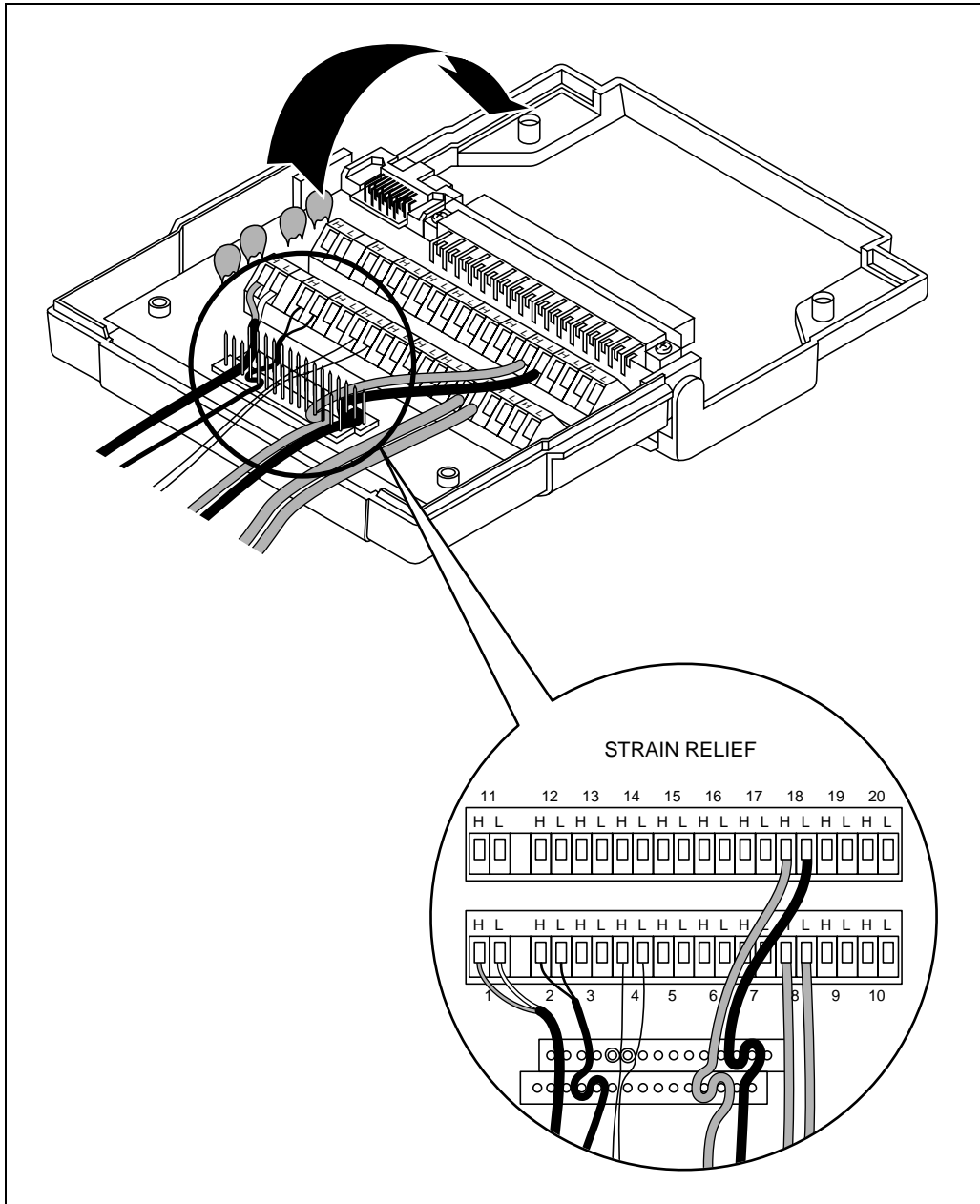
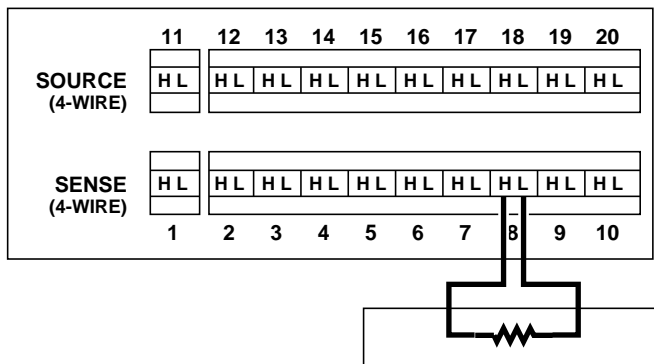

Figure 2-3. Universal Input Module Connections

2-WIRE (2W) CONNECTION



Use H and L terminals for any channel.

- Channels 1 through 20 on rear panel input module (Channel 8 shown here).

4-WIRE (4W) CONNECTION

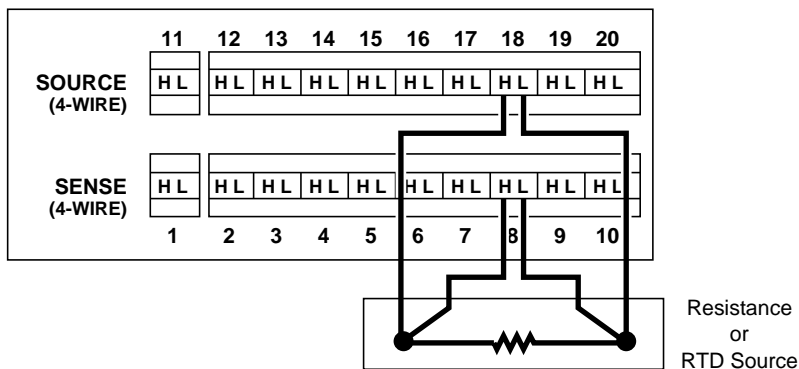

Use H and L terminals for two channels on rear panel input module. Connections for Channel 8 are shown here with Channel 18 providing the additional two connections.

For each 4-wire connection, one Sense Channel (1 through 10) and one Source Channel (Sense Channel number +10 = 11 through 20) are used.

Figure 2-4. 2-Wire and 4-Wire Connections

Shielded Wiring

2-10.

Use shielded wires and sensors (such as thermocouples) in environments where electrical noise is present, and connect the wire shield to the chassis ground terminal. Also refer to Appendix B "Noise, Shielding and Crosstalk Considerations."

Crosstalk Considerations

2-11.

Crosstalk between measurement lines causes one signal to interfere with another, introducing measurement errors. To reduce the effects of crosstalk, check the following:

- **Separate Wiring** Keep any input wiring carrying ac voltage signals physically separate from the input wiring of sensitive channels. Also keep input wiring separated from, or shielded from, ac power mains wiring.
- **Adjacent Channels** Avoid connecting input with ac voltage signals next to sensitive channel inputs. Leave unconnected channels between the inputs when possible.
- **Sensitive Channels** Avoid connecting inputs with ac voltage signals adjacent to four-terminal input channels.
- **High Impedance Inputs** Avoid high-source impedances on sensitive channels, or minimize the capacitance of the sensitive channel to earth (chassis) ground for high impedance inputs.
- **Precision Resistance Measurements** Avoid connecting any ac voltage inputs when making peak-accuracy high resistance measurements (resistance greater than 10 k Ω).

See Appendix B "Noise, Shielding and Crosstalk Considerations" for a complete discussion of crosstalk and measurement errors.

Digital I/O Connections

2-12.

Caution

To avoid damage to the instrument, do not apply any voltages greater than 30V maximum between the DIGITAL I/O connector terminals and earth ground.

The 10-terminal DIGITAL I/O connector (Figure 2-5) on the rear panel of the instrument provides connection to the Digital I/O and Totalizer functions.

Complete the following procedure to make a connection to these functions:

1. Remove the DIGITAL I/O connector from the packing material or instrument rear panel.

2. Loosen the wire clamp screw for the associated terminal.
3. Feed the wire into the gap between the connector body and the wire clamp.
4. Tighten the wire clamp; do not overtighten and crush the wire.
5. Repeat steps 2 through 4 for each wire.
6. Insert the connector in the rear panel.

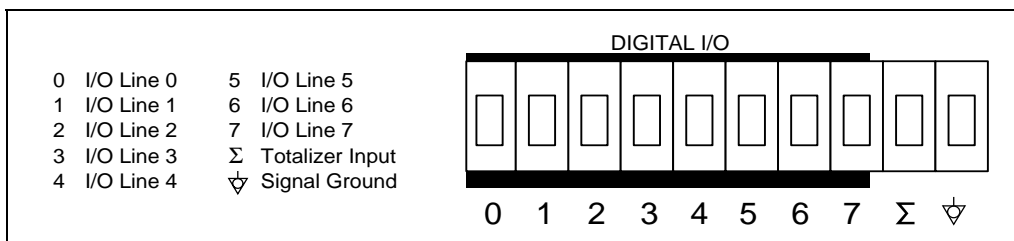

Figure 2-5. DIGITAL I/O Connector

Digital I/O

2-13.

The Digital I/O lines use terminals 0 to 7 and GND. You can use these lines either as signal inputs or as alarm outputs. See Table A-3 in Appendix A for complete specifications.

Totalizer

2-14.

The Totalizer uses terminals Σ and GND. The Totalizer counts contact closures or voltage transitions with a maximum count of 4,294,967,295. See Table A-7 in Appendix A for complete specifications.

Alarm/Trigger I/O Connections

2-15.

Caution

To avoid damage to the instrument, do not apply any voltages greater than 30V maximum between the ALARM/TRIGGER I/O connector terminals and earth ground.

The eight-terminal ALARM/TRIGGER I/O connector (Figure 2-6) on the rear panel of the instrument provides connections to Trigger In (TI), Trigger Out (TO), and Master Alarm (MA) I/O lines along with a common ground connection. (See the "Trigger Input," "Trigger Output," and "Master Alarm Output" discussions in Chapter 1 for additional information.) The dc power connection is also on this connector. (See "DC Power" above.)

Complete the following procedure to make a connection to the ALARM/TRIGGER I/O connector:

1. Remove the ALARM/TRIGGER I/O connector from the rear panel.
2. Loosen the wire clamp screw for the associated terminal.
3. Feed the wire into the gap between the connector body and the wire clamp.
4. Tighten the wire clamp; do not overtighten and crush the wire.
5. Repeat steps 2 through 4 for each wire.
6. Insert the connector in the rear panel.

Trigger Input

2-16.

Trigger Input uses terminals TI and GND. A contact closure or a TTL low signal input between TI and GND triggers instrument scanning when you select External Trigger as a scan parameter. (See "Scan Parameters" in Chapter 3) A TTL signal input triggers on the falling edge of the signal. A contact closure input triggers on the "close" portion of the switch sequence, open-close-open. Scanning continues at the Interval 2 rate while TI is held low. See Table A-4 in Appendix A for specifications.

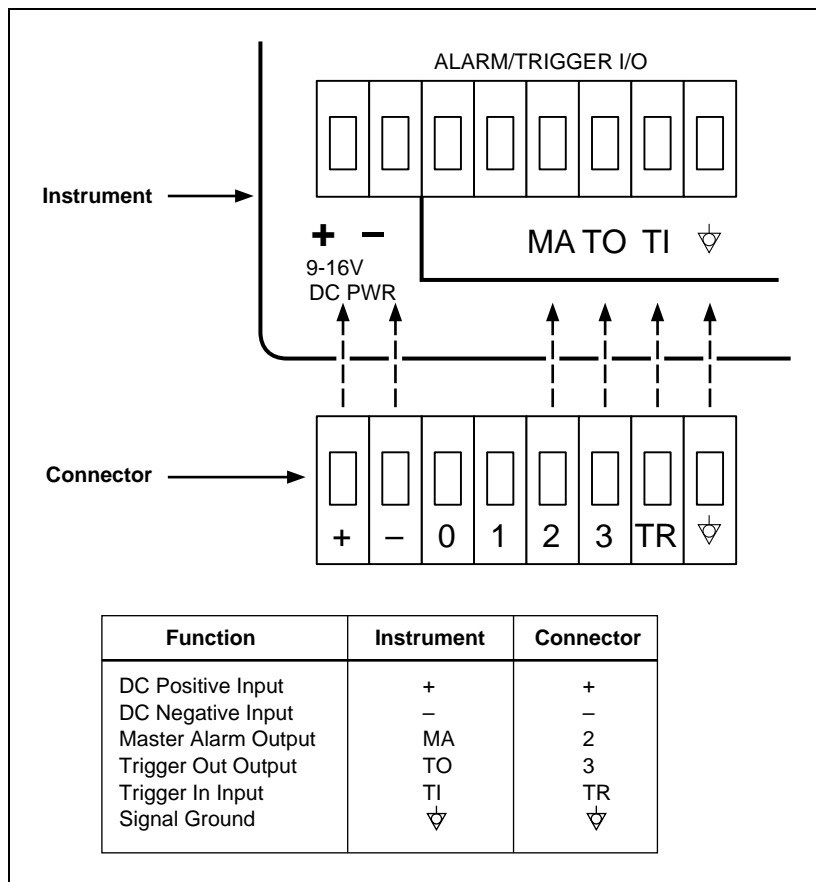

Figure 2-6. ALARM/TRIGGER I/O Connector

Trigger Output

2-17.

Trigger Output uses terminals TO and GND, and is a TTL signal that goes to a logic low for 125 μ s every time a scan begins. Use the Trigger Output to trigger other instruments via their Trigger Input connection and to interface with external equipment. To enable or disable the Trigger Output, see "Trigger Out" in Chapter 3 of this manual. The trigger output default is OFF. See Table A-5 in Appendix A for complete specifications.

Master Alarm

2-18.

Master Alarm uses terminals MA and GND. It is a TTL signal that goes to a logic low when any channel is in alarm while the instrument is scanning. This TTL signal output can interface with external equipment such as warning lights, alarms, paging systems, etc. See Table A-6 in Appendix A for complete specifications.

External Trigger Wiring for a Group Instrument

2-19.

External Trigger Wiring for a group instrument refers to the triggering configuration in which you connect the Master TO (Trigger Out) line to each Slave TI (Trigger In) line and provide a common connection to the GND line for each instrument. This configuration provides improved synchronization of the group instrument when the scanning intervals are 1 second or less.

Figure 2-7 shows a typical wiring connection for a group instrument. Use NetDAQ Logger to configure a group instrument as described in Chapter 3 of this manual.

Controls and Indicators

2-20.

The front panel provides a display and a set of control keys; the rear panel provides the power switch and Ethernet status indicators. See Figures 1-2 through 1-4 for an overall view of front and rear panels, and "Front Panel Operating Procedures" later in this chapter for procedures that use the front and rear panel controls and indicators.

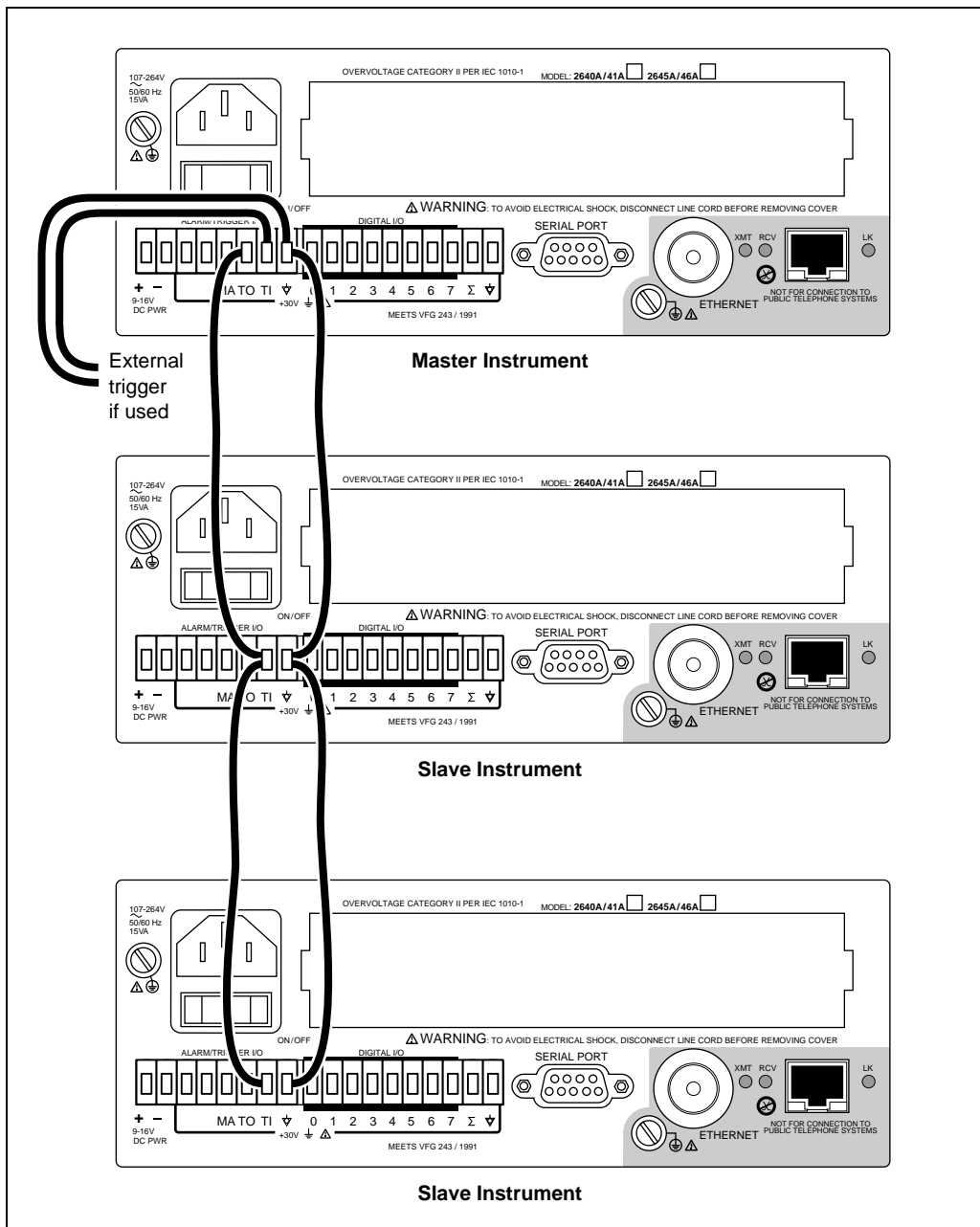

Figure 2-7. External Trigger Wiring for a Group Instrument

Front Panel Controls

2-21.

Use the front panel controls (Figure 2-8) to enter configuration parameters, and choose monitoring functions. Table 2-1 summarizes the front panel control functions.

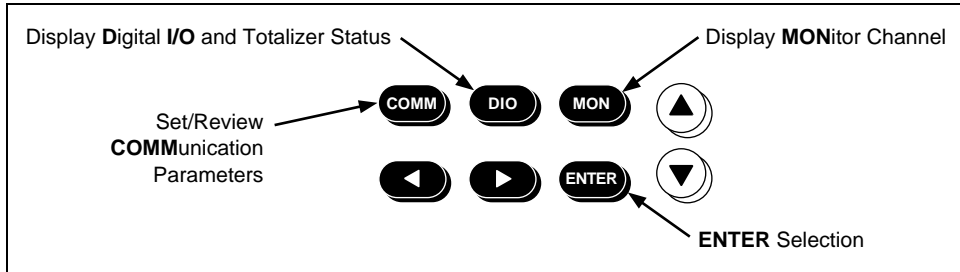

Figure 2-8. Front Panel Controls

Table 2-1. Front Panel Key Descriptions

Key	Description
COMM	Communication - Set up communication parameters. To review, just press COMM; to set, press and hold COMM for 3 seconds until the SET annunciator lights. If you press COMM again during configuration operations, the operation cancels. The COMM parameters are as follows: Base Channel Number (01 to 99) Line Frequency (50 or 60 Hz) Ethernet Address (Read Only) RS-232 (Baud Rate) Network Isolated Network General Network Internet Protocol (IP) Address Socket Port Subnet Mask Default Gateway Address
DIO	Digital I/O - Display Digital I/O Status and Totalizer count. After pressing DIO, use the left/right arrow keys to display the DIO status and the up/down arrow keys to display the totalizer status.
MON	Monitor - Display Monitor Channel. After pressing MON, use the up/down arrow keys to select the desired channel to monitor.
ENTER	Enter - Make Configuration Selection or Terminate Parameter Entry.
Left/Right Arrows	Used to make selections in setup menus. The arrow keys have an automatic repeat action when held down for more than 1 second.
Up/Down Arrows	Used to make selections in setup menus and select monitor channels. The arrow keys have an automatic repeat action.

Front Panel Indicators

2-22.

The front panel indicators (Figure 2-9) consist of two five-digit displays and a set of annunciators. Table 2-2 summarizes the front panel indicator functions.

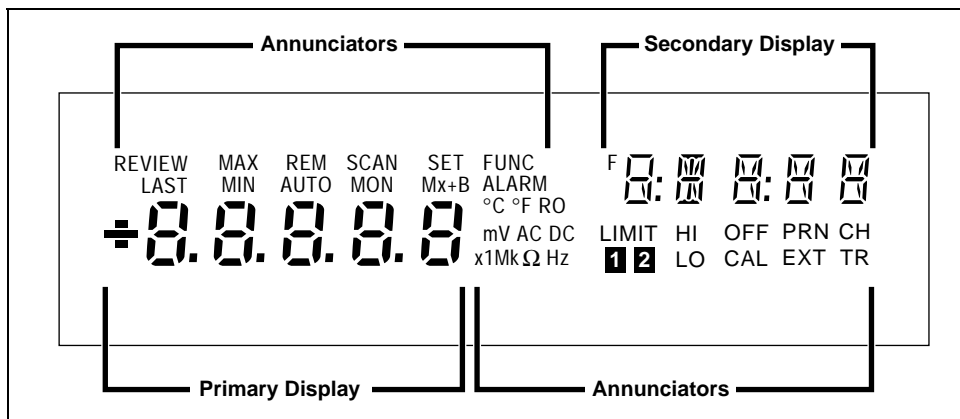

Figure 2-9. Front Panel Indicators

Table 2-2. Annunciator Display Descriptions

Annunciator	Description
REVIEW	Displays while reviewing the instrument parameters.
MAX	(Not Used.)
REM	Indicates active communications connection with the host computer (bright display) or inactive communications (dim display).
SCAN	Displays while the instrument is scanning.
SET	Displays while setting the instrument parameters.
FUNC	Displays while monitoring a computed channel.
F	(Not Used.)
LAST	(Not Used.)
MIN	(Not Used.)
AUTO	Displays while monitoring a channel with Autorange selected.
MON	Displays while monitoring a channel.
Mx+B	Displays bright while monitoring a channel scaled with an M value other than 1 and/or a B value other than 0.
ALARM	Displays dim when the rear panel Master Alarm (MA) is logic low, meaning one of the instrument channels is in alarm. Displays bright when an alarm channel is being used as an Alarm Trigger.

Table 2-2. Annunciator Display Descriptions (cont)

Annunciator	Description
°C	Displays when you monitor a channel for which the measurement function is in degrees Celsius.
°F	Displays when you monitor a channel for which the measurement function is in degrees Fahrenheit.
R0	(Not Used.)
m	Displays when you monitor a channel for which the measurement value is scaled by .001 (milli).
V	Displays when you monitor a channel for which the measurement function is volts. Operates in conjunction with the AC and DC annunciators.
AC	Displays when you monitor a channel for which the measurement function is in Alternating Current (AC).
DC	Displays when you monitor a channel for which the measurement function is in Direct Current (DC).
x1	(Not used.)
M	Displays when you monitor a channel for which the measurement value is scaled by 1,000,000 (mega).
k	Displays when you monitor a channel for which the measurement value is scaled by 1,000 (kilo).
Ω	Displays when you monitor a channel for which the measurement function is in Ohms.
Hz	Displays when you monitor a channel for which the measurement function is in Hertz.
LIMIT	(Not used.)
HI	(Not used.)
OFF	(Not used.)
PRN	(Not Used.)
CH	Displays when the channel number is in the secondary display.
1	(Not used.)
2	(Not used.)
LO	(Not used.)
CAL	Displays when the instrument internal calibration constants become corrupted.
EXT	Displays when the External Trigger is enabled while scanning.
TR	Displays when Alarm Trigger or External Trigger is enabled while scanning.

Rear Panel Controls

2-23.

The rear panel has a single control: the power switch (Figure 2-10). The power switch controls both ac and dc power inputs.

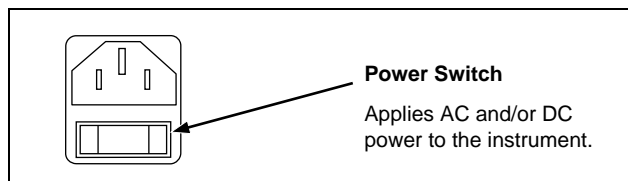

Figure 2-10. Rear Panel Controls

Rear Panel Indicators

2-24.

The rear panel has three LED indicators for the Ethernet adapter (Figure 2-11).

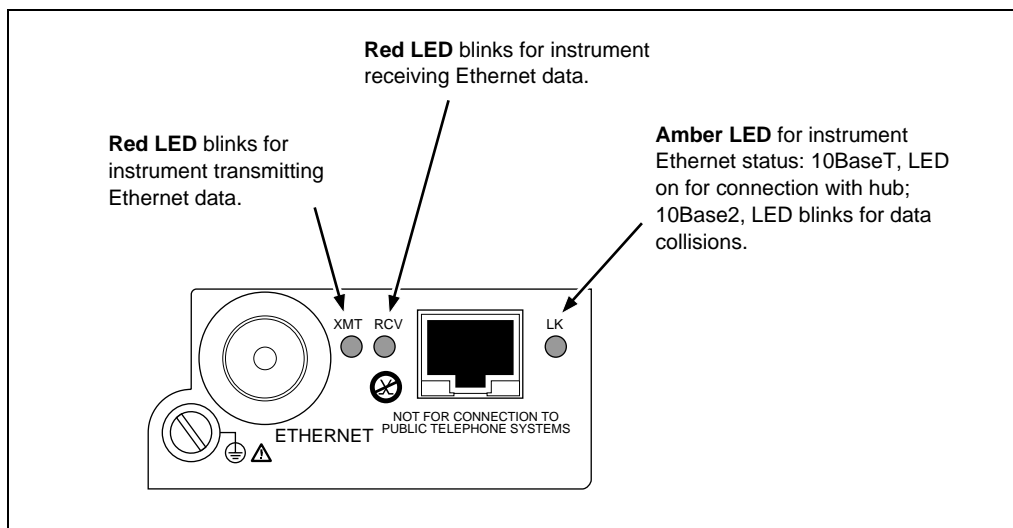

Figure 2-11. Rear Panel Indicators

Front Panel Operating Procedures

2-25.

Power-On Options

2-26.

There are three power-on options as listed below:

- **Normal Power-On** Turn power switch on. The instrument communication parameters are the same as when the instrument was last turned off.
- **Configuration-Reset Power-On** Hold the front panel COMM key down, and then turn the power switch on. Continue holding the COMM key until the instrument beeps. The communication parameters are reset to default values (see Table 2-3).
- **Display-Hold Power-On** Hold the front panel arrow-left (<) key down, and then turn the power switch on. Continue holding the < key until the instrument beeps. The instrument front panel display remains on until you press any front panel key. This allows inspection of the display segments.

Each power-on sequence includes a four-second self-test routine. If the self-test fails, the instrument displays ERROR in the primary display with a code character in the secondary display. See Chapter 6 "Maintenance" for information on error codes. Power-on also clears channel configuration data and sets all channels to OFF.

Table 2-3. Instrument Default Parameters

Parameter	Default Setting
Base Channel Number	1
Line Frequency	60 Hz
Network Selection	Isolated Network
Socket Port	4369
Internet Protocol Address	---.---.---.--- (dashes)
Baud Rate	19200
Default Gateway	OFF

Displaying a Monitor Channel

2-27.

Perform the procedure in Figure 2-12 to monitor an instrument analog channel (01 to 20) or computed channel (21 to 30). See Figure 2-13 for examples.

- **Channel Display** When you press the MON key, the first monitor channel displayed is the channel most recently monitored. After power-on, reset, configuration, or self-test commands, the channel displayed is the lowest numbered configured channel. When no channels are configured, monitoring is not available. (Under this condition, an error beep occurs when you press the Monitor key.)
- **Monitor Display** The initial monitor display is a series of dashes, which lasts for approximately one second. The measurement then appears in the primary display (the secondary display shows the Global Channel Number). The MON (monitor) annunciator is on when monitoring.
- **Monitor Reading Updates** The instrument updates monitor readings once per second. Since the 2640A measures readings with 5 ½ digits of resolution and the display can only show 5 digits of resolution, the least significant digit is truncated for 2640A monitor displays.

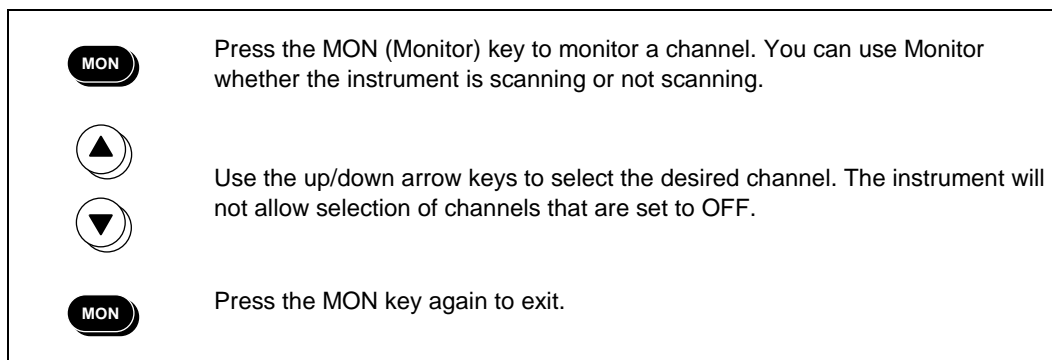
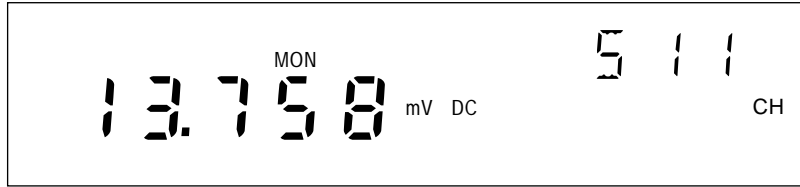
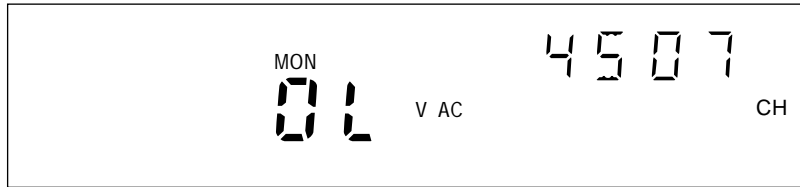

Figure 2-12. Displaying a Monitor Channel



Monitor display for 13.758 mV DC, GCN (Global Channel Number) 511



Monitor display for Scale Overload V AC (reading is greater than the selected range), GCN 4507

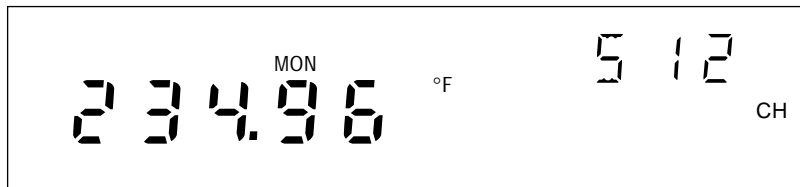

Monitor display for 234.96°F (Thermocouple), GCN 512 (**otc** displays for open thermocouple)

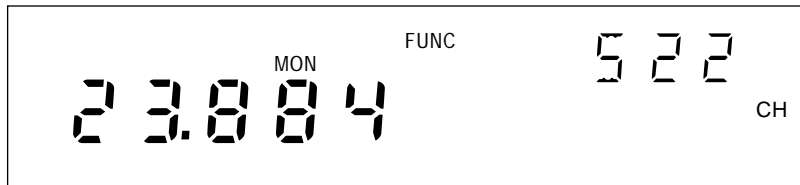

Monitor display for 23.884 FUNC (Computed Channel), GCN 522

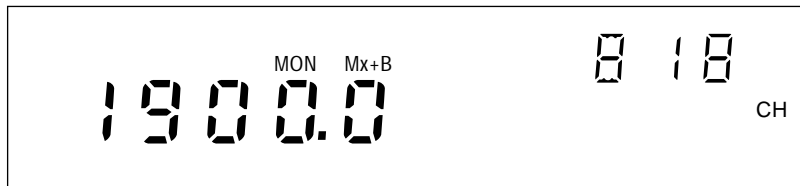

Monitor display for analog channel 18 with Mx+B scaling, GCN 818

Figure 2-13. Examples During Monitor

Displaying the Digital I/O Status

2-28.

Perform the procedure in Figure 2-14 to display an instrument Digital I/O line status. The instrument updates the DIO display once per second. (See Figure 2-15 for examples.)

- **Number Of DIO Lines** There are eight DIO lines: DIO 0 to DIO 7. You can assign DIO lines as alarm outputs or as digital inputs. For example, a switch closure can toggle a DIO line as an input.
- **DIO Status Display** DIO status display is in the form nnnn-nnnn with five characters in view at a time.

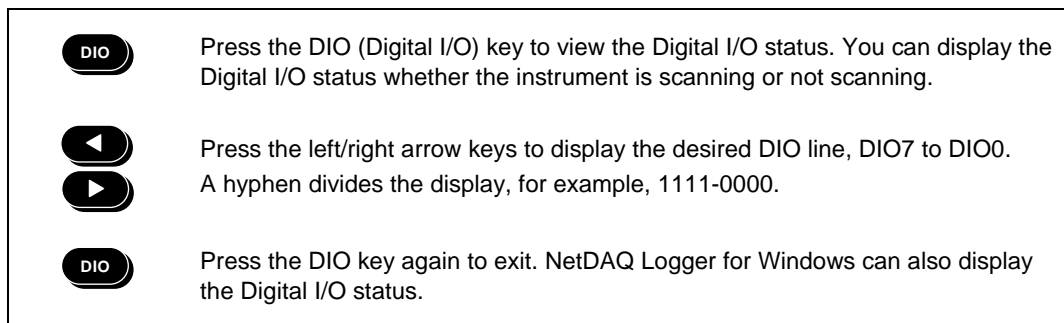
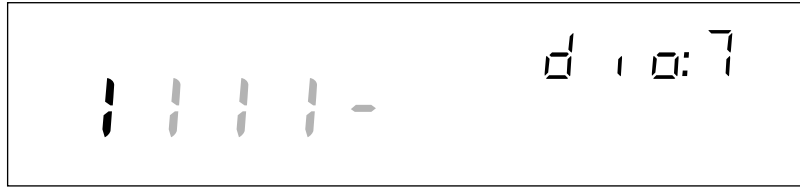

Figure 2-14. Displaying the Digital I/O Status

Input example Toggling DIO7 between open circuit and ground results in I/O status of 255 (11111111) and 127 (01111111). The changes from 255 to 127 in your scan data provide a direct correlation between the external condition at DIO7 and the analog and computed measurements.

Output example Associating I/O line DIO0 with an alarm results in I/O status of 255 (11111111) when the channel is not in alarm and 254 (11111110) when the channel is in alarm. External equipment such as warning lights can process the logic low output on the Digital I/O connector.

Associating an I/O line with an alarm condition is part of the alarm's configuration procedure. (See "Alarms" in Chapter 3 of this manual.)



Digital I/O status display for DIO line 7 (for the example 1111-0000)

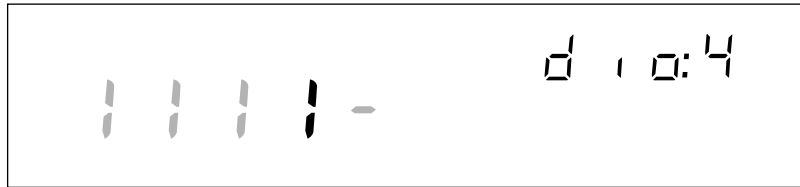

Digital I/O status display for DIO line 4 (for the example 11111-0000)



Digital I/O status display for DIO line 0 (for the example 1111-0000)

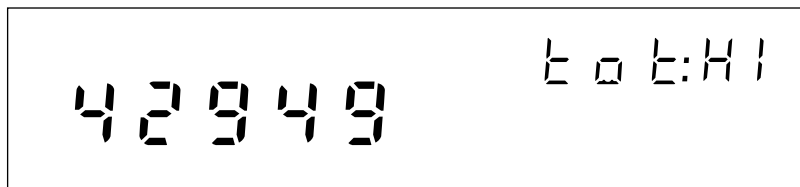

Totalizer status display for the high digits (for the example 4294967295)

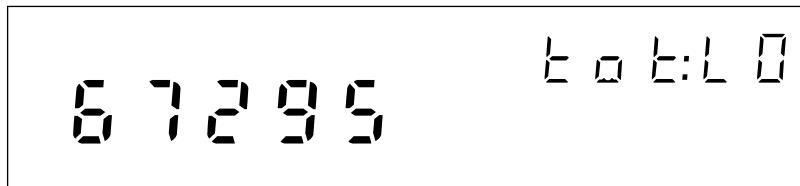

Totalizer status display for the low digits (for the example 4294967295)

Figure 2-15. Examples for Digital I/O and Totalizer Status

Displaying the Totalizer Status

2-29.

Perform the procedure in Figure 2-16 to display the instrument Totalizer status. The instrument updates the Totalizer display once per second. (See Figure 2-15 for examples.) To clear the Totalizer count, cycle the instrument power. You can also configure NetDAQ Logger to clear the Totalizer count when it starts logging.

- **Maximum Totalizer Count** The Totalizer counts switch closures or voltage transitions with a maximum count of 4,294,967,295.
- **Totalizer Status Display** The instrument displays the Totalizer status in two five-digit segments; high (HI) and low (LO). Using the maximum count of 4,294,967,295 as an example, the HI five-digit segment would display 42949 and the LO five-digit segment 67295.





	Press the DIO (Digital I/O) key to view the Totalizer status. You can view the Totalizer status whether the instrument is scanning or not scanning.
 	Press an up/down arrow key to advance to the Totalizer display. The 10 digits display in a five-digit tot:HI count and five-digit tot:LO count.
	Press the DIO key again to exit. NetDAQ Logger also provides a display of the Totalizer status.

Figure 2-16. Displaying the Totalizer Status

Reviewing and Setting the Base Channel Number

2-30.

Perform the procedure in Figure 2-17 to review or set the Base Channel Number (BCN). The BCN identifies the instrument. The BCN is also the first two digits of the Global Channel Number (GCN), which uniquely identifies each instrument channel. For example, a GCN of 2716 indicates instrument 27 and analog channel 16. (See Figure 2-18 for examples.)

- **BCN Range** The BCN can be any number from 01 to 99. If you plan to install NetDAQ Logger for isolated network operation, each instrument on the network must have a unique BCN.
- **BCN Review or Set identifier** The REVIEW annunciator displays when reviewing the BCN; the SET annunciator displays when setting the BCN.









	Press the COMM key to <u>review</u> the Base Channel Number (BCN), or press and hold the COMM key for 3 seconds to <u>set</u> the BCN.
	Press the up/down arrow keys until bASE (Base Channel Number) appears in the primary display (COMM appears in the secondary display).
	
	Press the ENTER key. bASE appears in the secondary display and the current BCN (two digits) in the primary display.
	For BCN <u>set</u> procedures, press the left/right arrow keys to select the BCN 10s or 1s digit position (highlighted).
	
	Press the up/down arrow keys to select the desired number, 0 to 9, for the positioned BCN digit. In this manner, set both BCN digits.
	
	Press the ENTER key to exit. (Pressing any other function key will cancel <u>set</u> operations.)

Figure 2-17. Reviewing and Setting the Base Channel Number



Communications display for reviewing the Base Channel Number (BCN)

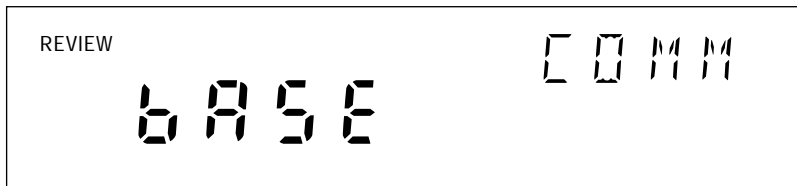
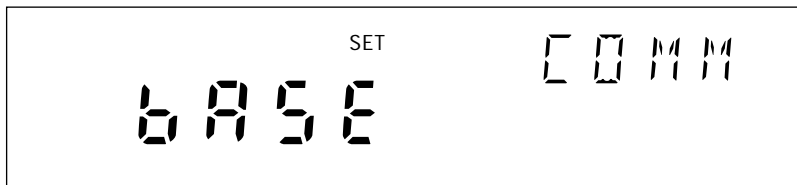

Communications display for setting the BCN



Base Channel Number display for setting the BCN 10s digits (for example, 45)

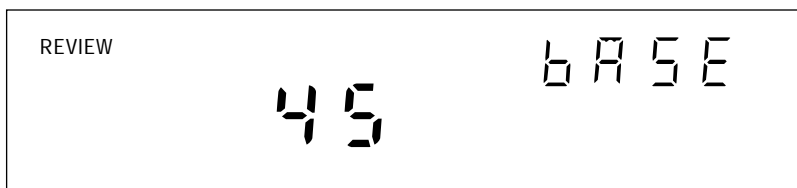

Base Channel Number display for reviewing the BCN number (for example, 45)



Front Panel display for an instrument with BCN 45

Figure 2-18. Examples for Reviewing and Setting the BCN

Reviewing and Setting the Line Frequency

2-31.

Perform the procedure in Figure 2-19 to review or set the line frequency. Line frequency selection allows the instrument to optimize internal circuitry for maximum precision. (See Figure 2-20 for examples.)

- Line Frequency Choices** Select 50 Hz or 60 Hz as the frequency of the primary power when an ac source powers the instrument.





	Press the COMM key to <u>review</u> the Line Frequency setting, or press and hold the COMM key for 3 seconds to <u>set</u> the Line Frequency.
	Press the up/down arrow keys until LinE (Line Frequency) appears in the primary display (comm appears in the secondary display).
	Press the ENTER key. LinE appears in the secondary display and the current LinE frequency setting is in the primary display.
	For Line Frequency <u>set</u> procedures, press the up/down arrow keys to select 50 (Hz) or 60 (Hz) line frequency (current setting appears bright).
	Press the ENTER key to exit. (Pressing any other function key will cancel <u>set</u> operations.)

Figure 2-19. Reviewing and Setting the Line Frequency

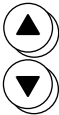

Communications display for reviewing the line frequency

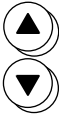

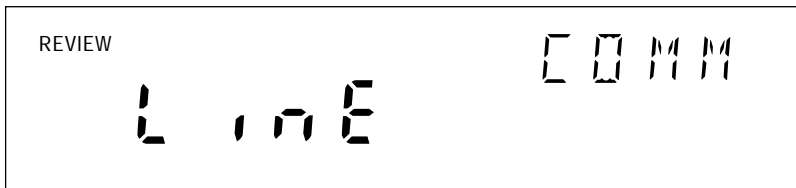
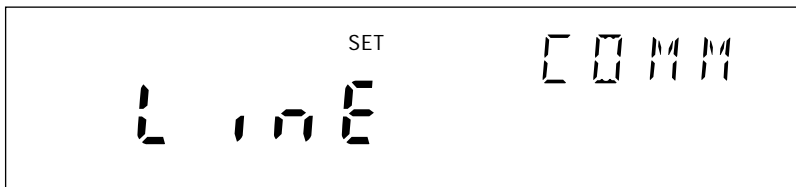
Communications display for setting the line frequency

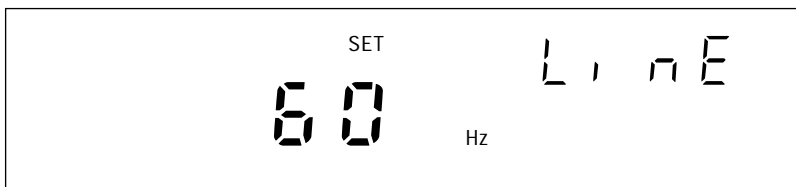

Line frequency display for setting the line frequency to 60 Hz

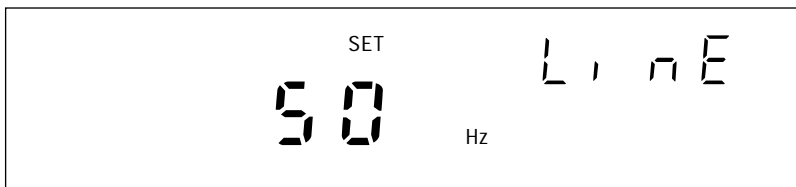

Line frequency display for setting the line frequency to 50 Hz

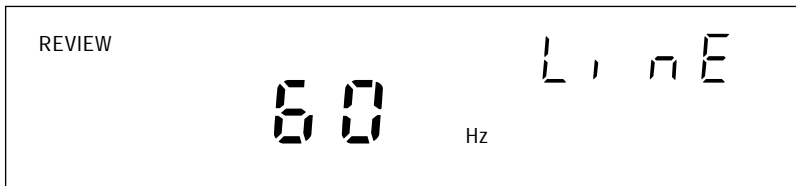

Line frequency display for reviewing the line frequency (60 Hz)

Figure 2-20. Examples for Reviewing and Setting the Line Frequency

Reviewing and Setting the Network Type

2-32.

Perform the procedure in Figure 2-21 to review or set the network type to isolated. Perform the procedure in Figure 2-23 to review or set the network type to general. An isolated network consists of only NetDAQ instruments and one or more host computers. A general network consists of instruments, host computers, and possibly servers, routers, gateways, or other network devices. (See Figure 2-22 for examples.)

If you install NetDAQ Logger for isolated network operation and set the instruments' network type to isolated, you do not need to know or set IP addresses for your instruments.







	Press the COMM key to <u>review</u> the network type, or press and hold the COMM key for 3 seconds to <u>set</u> the network type.
	Press the up/down arrow keys until nEt (Network) appears in the primary display (comm appears in the secondary display).
	
	Press the ENTER key. nEt appears in the secondary display and ISo (isolated network) or gEn (general network) is in the primary display.
	To <u>set</u> the network type to isolated, press the up/down arrow keys to select ISo (current setting appears bright).
	
	Press the ENTER key to exit. (Pressing any other function key will cancel <u>set</u> operations.)

Figure 2-21. Reviewing and Setting the Network Type to Isolated



Communications display for reviewing the network type

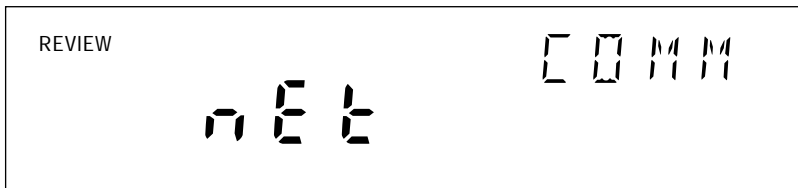

Communications display for setting the network type

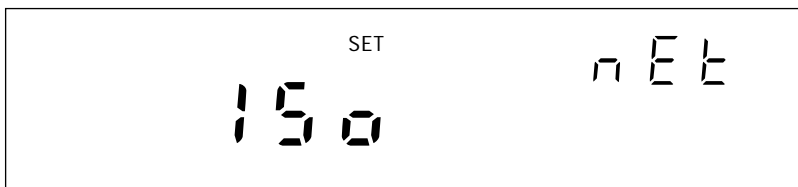

Network display for setting the network type to isolated



Network display for setting the network type to general



Network display for reviewing the network type (isolated network)

Figure 2-22. Examples for Reviewing and Setting the Network Type

If you install NetDAQ Logger for general network operation, you must set the network type of each instrument to general. You will need to enter an IP address, socket port, and possibly a subnet mask and gateway address into each instrument. Get this information from your network administrator.







	Press the COMM key to <u>review</u> the network type, or press and hold the COMM key for 3 seconds to <u>set</u> the network type.
	Press the up/down arrow keys until nEt (Network) appears in the primary display (comm appears in the secondary display).
	Press the ENTER key. nEt appears in the secondary display and ISo (isolated network) or gEn (general network) is in the primary display.
	To <u>set</u> the network type to general, press the up/down arrow keys to select gEn (current setting appears bright).
	Press the ENTER key. (Pressing any other function key will cancel <u>set</u> operations.) This displays the current Socket Port.
	Press the ENTER key. This displays the first digit of the Internet Protocol address (segment IP:0).
	Press the ENTER key to exit. You must also set an IP address and Socket Port when using a general network.

Figure 2-23. Reviewing and Setting the Network Type to General

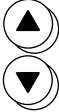

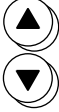
Communications display for reviewing the network type

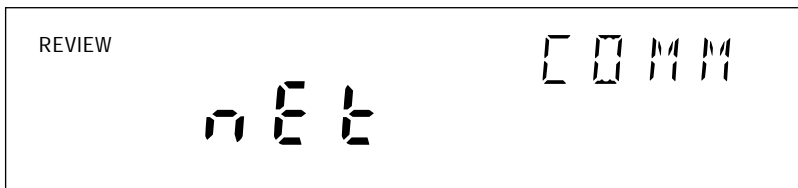
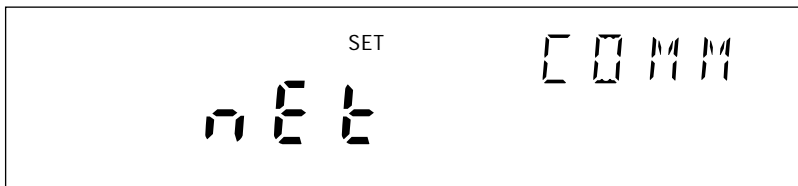

Communications display for setting the network type



Network display for setting the network type to general



Socket Port display for setting the first digit (for the example 04369)



Socket Port display for setting the second digit (for the example 04369)

Figure 2-24. Examples for Reviewing and Setting General Network Parameters

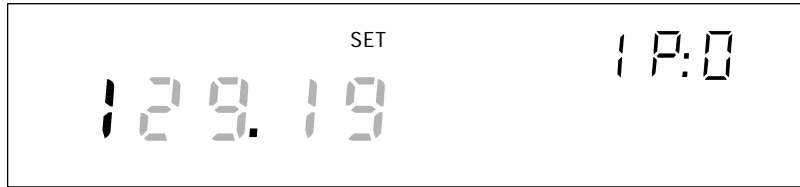

IP address display for setting an IP:0 digit (for example, 129:196:152:101)

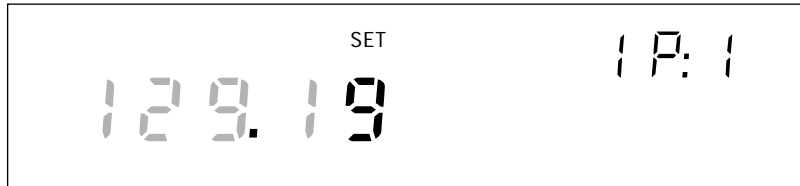

IP address display for setting an IP:1 digit (for example, 129:196:152:101)



IP address display for setting an IP:1 digit (for example, 129:196:152:101)

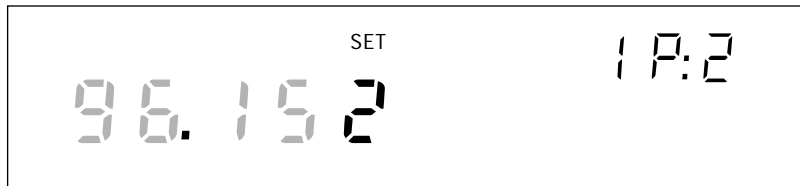

IP address display for setting an IP:2 digit (for example, 129:196:152:101)

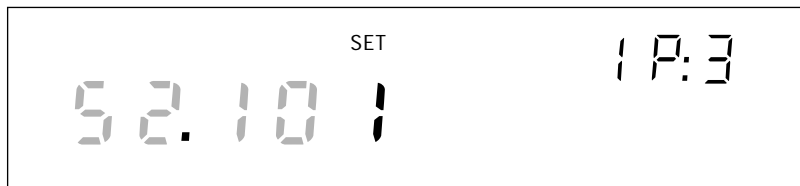

IP address display for setting an IP:3 digit (for example, 129:196:152:101)

Figure 2-24. Examples for Reviewing and Setting General Network Parameters (cont)

Reviewing and Setting the General Network Socket Port

2-33.

Perform the procedure in Figure 2-25 to review or set the general network Socket Port (1024 to 65535). The default is 04369. In order to communicate with each other, a host computer and an instrument must use the same socket port number. (See Figure 2-25 for examples.)

- **General Network Socket Port** Enter the Socket Port supplied by your network administrator.













	Press the COMM key to <u>review</u> the network settings, or press and hold the COMM key for 3 seconds to <u>set</u> the network settings.
 	Press the up/down arrow keys until nEt (Network) appears in the primary display (comm appears in the secondary display).
	Press the ENTER key. nEt appears in the secondary display and ISo (isolated network) or gEn (general network) is in the primary display.
 	To <u>set</u> the network type, press the up/down arrow keys to select gEn.
	Press the ENTER key. (Pressing any other function key will cancel <u>set</u> operations.) This displays the current Socket Port.
 	To <u>set</u> the socket port, press the left/right arrow keys to select the desired digit position (highlighted).
 	Press the up/down arrow keys to select the desired number, 0 to 9, for the positioned Port digit. In this manner, select all Port digits.
	Press the ENTER key. This displays the first digit of the Internet Protocol address segment IP:0.
	Press the ENTER key to enter the <u>settings</u> and exit the procedure. (Pressing any other function key will cancel <u>set</u> operations.)













Figure 2-25. Reviewing and Setting the General Network Socket Port

Reviewing and Setting the General Network IP Address

2-34.

Perform the procedure in Figure 2-26 to review or set the instrument's general network Internet Protocol (IP) address. (See Figure 2-24 for examples.)

- **General Network IP Address** Enter the IP Address supplied by your network administrator and recorded inside the rear cover of this manual for each BCN. The format is four 3-digit segments: IP0.IP1.IP2.IP3.

	Press the COMM key to <u>review</u> the network settings, or press and hold the COMM key for 3 seconds to <u>set</u> the network settings.
 	Press the up/down arrow keys until nEt (Network) appears in the primary display (comm appears in the secondary display).
	Press the ENTER key. nEt appears in the secondary display and ISo (isolated network) or gEn (general network) is in the primary display.
 	To <u>set</u> the network type, press the up/down arrow keys to select gEn.
	Press the ENTER key. (Pressing any other key will cancel <u>set</u> operations.) This displays the current Socket Port.
	Press the ENTER key. This displays the first digit of the 12-digit Internet Protocol address (grouped into four 3-digit segments: IP0 . IP1 . IP2 . IP3).
 	Press the left/right arrow keys to select the desired number in each segment. The selected digit is highlighted and the segment, for example, IP2, appears.
 	Press the up/down arrow keys to select the desired number, 0 to 9, for the positioned IP digit. In this manner, select all 12 IP digits.
	Press the ENTER key to enter the <u>settings</u> and exit the procedure. (Pressing any other function key will cancel <u>set</u> operations.).

2-26. Reviewing and Setting the General Network IP Address

Reviewing and Setting the Subnet Mask and Default Gateway

2-35.

If communication between the host computer and the NetDAQ instrument passes through a router or gateway, you must set the subnet mask and default gateway address on both the host computer and the instrument. Get this information from your network administrator.

For more information on the purpose of the subnet mask and default gateway address, see Appendix I, “Network Considerations.”

Perform the procedure in Figure 2-27 to review or set the instrument network gateway parameters. The network gateway parameters include turning the default gateway feature on or off, setting a subnet mask, and setting an IP address for the gateway attached to the local network.

Note

Set the IP address of the instrument before the setting gateway parameters. The NetDAQ instrument checks the gateway IP address for validity by using the instrument IP address.

- **Default Gateway Parameters** If the NetDAQ instrument and host PC are on different subnets and must communicate through a gateway (router), turn the default gateway feature ON and enter the subnet mask and IP address of the gateway, as supplied by your network administrator. If you do not require a gateway, turn the default gateway feature OFF.

- **Subnet Mask** The subnet mask is a 32-bit binary number expressed as four 3-digit segments, like an IP address. The subnet mask, when masked with the instrument IP address, determines what the network number is. For example, if the IP address is 129.196.180.93 and the subnet mask is 255.255.255.0, the network number is 129.196.180.0.

The subnet mask contains a consecutive set of bits, starting at the highest order bit, forming a binary mask value. For example, 255.255.0.0 (binary value FFFF0000 hex) is a valid mask, but 255.255.10.0 (binary value FFFF0A00 hex) is not a valid mask, because the bits are not consecutive. 0.255.255.0 (binary value 00FFFF00 hex) is also not a valid mask, because the bits do not begin at the highest order bit.

The subnet mask must also contain a minimum number of bits depending on the class of the instrument IP address. The minimum number of bits for a class A address is 255.0.0.0, class B is 255.255.0.0 and class C is 255.255.255.0. For example, if the IP address is 129.196.180.93, a class B address, a subnet mask of 255.0.0.0 is not valid, because there are too few subnet mask bits set.

- **Default Gateway IP Address** The default gateway IP address is the IP address of a gateway (router) attached to the same network as the instrument. When the instrument detects that a host PC is not on the same network (using the network number), the data is sent through the gateway to reach the host PC.

The network number of the instrument must match that of the gateway. For example, if the gateway IP address is 129.196.180.93, and the subnet mask is 255.255.255.0, the network number is 129.196.180.0, and the instrument IP address must be in the range 129.196.180.0 to 129.196.180.255.

















	Press the COMM key to <u>review</u> the parameters, or press and hold the COMM key for 3 seconds to <u>set</u> the parameters.
	Press the up/down arrow keys until dgAtE (default gateway) appears in the primary display (COMM appears in the secondary display).
	
	Press the ENTER key. dgAtE appears in the secondary display, and ON or OFF is in the primary display.
	Press the up/down arrow keys to select either ON or OFF when in <u>set</u> mode.
	
	Press the ENTER key to make the selection (pressing any other key will cancel <u>set</u> operations.). If you select ON, the subnet mask appears. The subnet mask display consists of four 3-digit segments: Sub0. Sub1. Sub2. Sub3.
	Press the left/right arrow keys to select the desired number in each segment. The selected digit is highlighted and the segment, for example Sub:0, appears in the secondary display.
	
	Press the up/down arrow keys to select the desired number 0 to 9, for the positioned subnet mask digit. In this manner, select all 12 subnet mask digits.
	
	Press the ENTER key to make the selection (pressing any other key will cancel <u>set</u> operations). If you enter an incorrect subnet mask, Error appears for 2 seconds, and the subnet mask selection stays displayed. Otherwise, the default gateway IP address appears. The default gateway display consists of four 3-digit segments: gAt0.gAt1.gAt2.gAt3.
	Press the left/right arrow keys to select the desired number in each segment. The selected digit becomes highlighted and the segment, e.g. gAt:0, appears in the secondary display.
	
	Press the up/down arrow keys to select the desired number 0 to 9, for the positioned default gateway IP digit. In this manner, select all 12 default gateway IP digits.
	
	Press the ENTER key to make the selection (pressing any other key will cancel <u>set</u> operations). If you enter an incorrect default gateway IP, Error displays for 2 seconds, and the default gateway IP selection stays displayed. Otherwise, the procedure exits.

Figure 2-27. Reviewing and Setting the Subnet Mask and Default Gateway

Viewing the Instrument Ethernet Address

2-36.

Perform the procedure in Figure 2-28 to view the Instrument Ethernet address. (See Figure 2-29 for examples.) The network administrator must know the instrument Ethernet address when the instrument operates on a general network. You do not need this information when you operate the instrument on an isolated network. For your convenience, record the Ethernet address inside the rear cover of this manual.

- **Ethernet Address Format** The Ethernet address is a 12-digit hexadecimal number. For example, 00:80:40:12:34:56. The first 6 hexadecimal digits represent a manufacturer, for example, 00:80:40 represents Fluke Corporation. The remaining digits are a sequential number assigned during manufacturing. Ethernet addresses are always unique; they are never altered, reused, or duplicated.
- **Ethernet Address Display** The Ethernet address display consists of six 2-digit segments: Eadr 0 to Eadr 5. In the example above, Eadr0=00, Eadr1=80, Eadr2=40, Eadr3=12, Eadr4=34, Eadr5=56.







	Press the COMM key to open the communications display because this is a review process only.
 	Press the up/down arrow keys until EAdr (Ethernet Address) appears in the primary display (comm appears in the secondary display).
	Press the ENTER key. Eadr0 appears in the secondary display, the first 5 digits of the Ethernet address appears in the primary display (always 00.80.4).
 	Press the left/right arrow keys to display each byte: Eadr0 (always 00), Eadr1 (always 80), Eadr2 (always 40), then Eadr3, Eadr4 and Eadr5.
	Press the COMM key again to exit. Record the Ethernet address inside the rear cover of this manual.

Figure 2-28. Viewing the Instrument Ethernet Address



Communications display for viewing the instrument Ethernet address

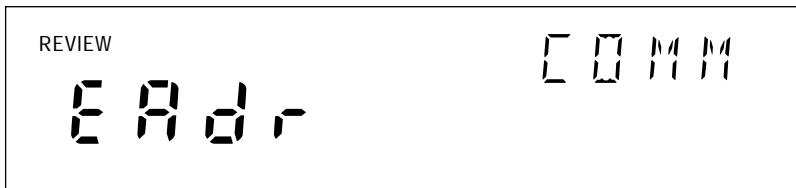
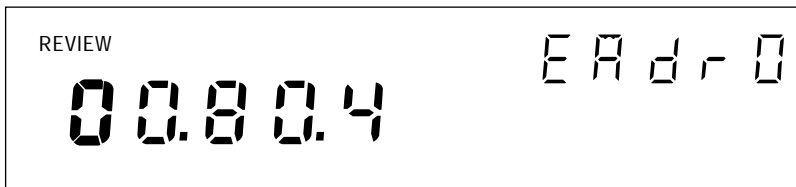

Ethernet address display for viewing byte 0 (for the example 00-80-40-12-34-56)

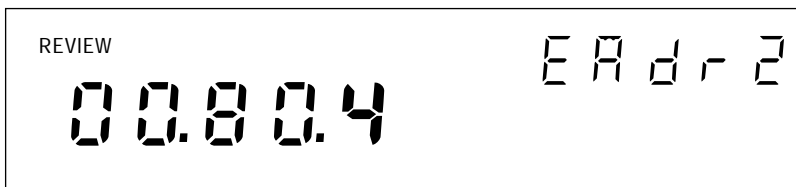

Ethernet address display for viewing byte 2 (for the example 00-80-40-12-34-56)

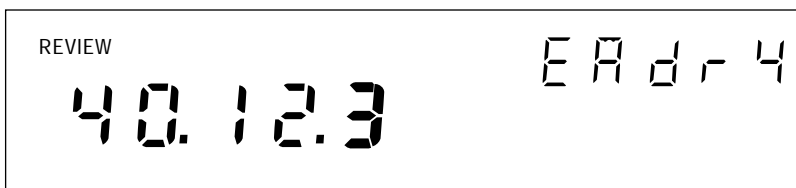

Ethernet address display for viewing byte 4 (for the example 00-80-40-12-34-56)

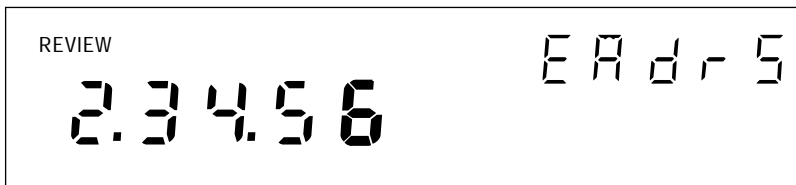

Ethernet address display for viewing byte 5 (for the example 00-80-40-12-34-56)

Figure 2-29. Examples for Viewing the Ethernet Address

Host Computer and Network Preparation

2-37.

This section contains information for preparing your host computer and setting up network communication, as summarized in Figure 2-30.

Installing Host Computer Ethernet Adapter

2-38.

Skip this section if you have an Ethernet adapter installed on your computer.

Since the installation procedures for Ethernet adapters change frequently and without notice, you must follow the instructions supplied with your particular Ethernet adapter. An external parallel-to-LAN adapter, such as the 246XA-802, is easier to install and configure than a plug-in card. If your host computer is already on a network, it probably has an Ethernet adapter already installed.

To install an Ethernet adapter, use the following procedure:

1. Close all applications. Exit Windows and turn the host computer off. This step is necessary for installing a parallel-to-LAN adapter as well as for installing a plug-in card.
2. Follow the installation instructions in the manual supplied with your Ethernet adapter to install the hardware. Do not install driver software at this point.

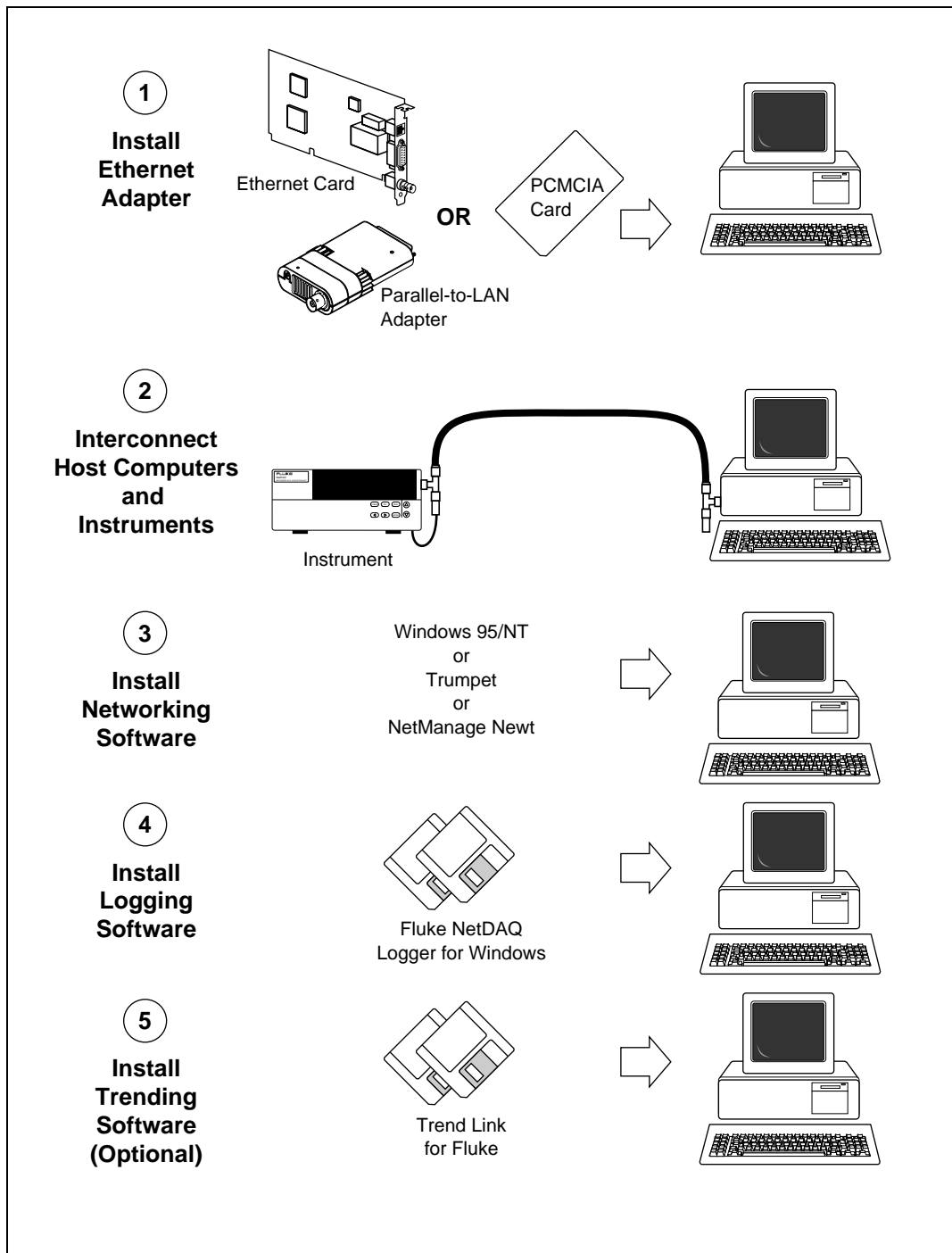

Figure 2-30. Preparing for Network Operation

Instrument and Host Computer Interconnection

2-39.

You may interconnect NetDAQ instruments and host computer(s) with either 10Base2 (coaxial) or 10BaseT (twisted pair) wiring. If your site is already wired, you will probably use the wire in place. If your site is not wired, and you are connecting your instrument directly to your host computer, it is easiest to use the coaxial cable supplied with your NetDAQ instrument.

Host Computer/Instrument Direct Connection

2-40.

You can connect one or more instruments directly to a host computer using 10Base2 cable. See *Interconnection Using 10Base2 (coaxial) Wiring* (Figure 2-31).

You can connect a single instrument directly to a host computer using 10BaseT cable, but you must use a special cable that has its transmit and receive lines crossed. The crossed lines allow each end to transmit to the receive terminal at the other end. See Figure 2-32 and “*Interconnection Using 10BaseT (Twisted Pair) Ethernet Wiring*”.

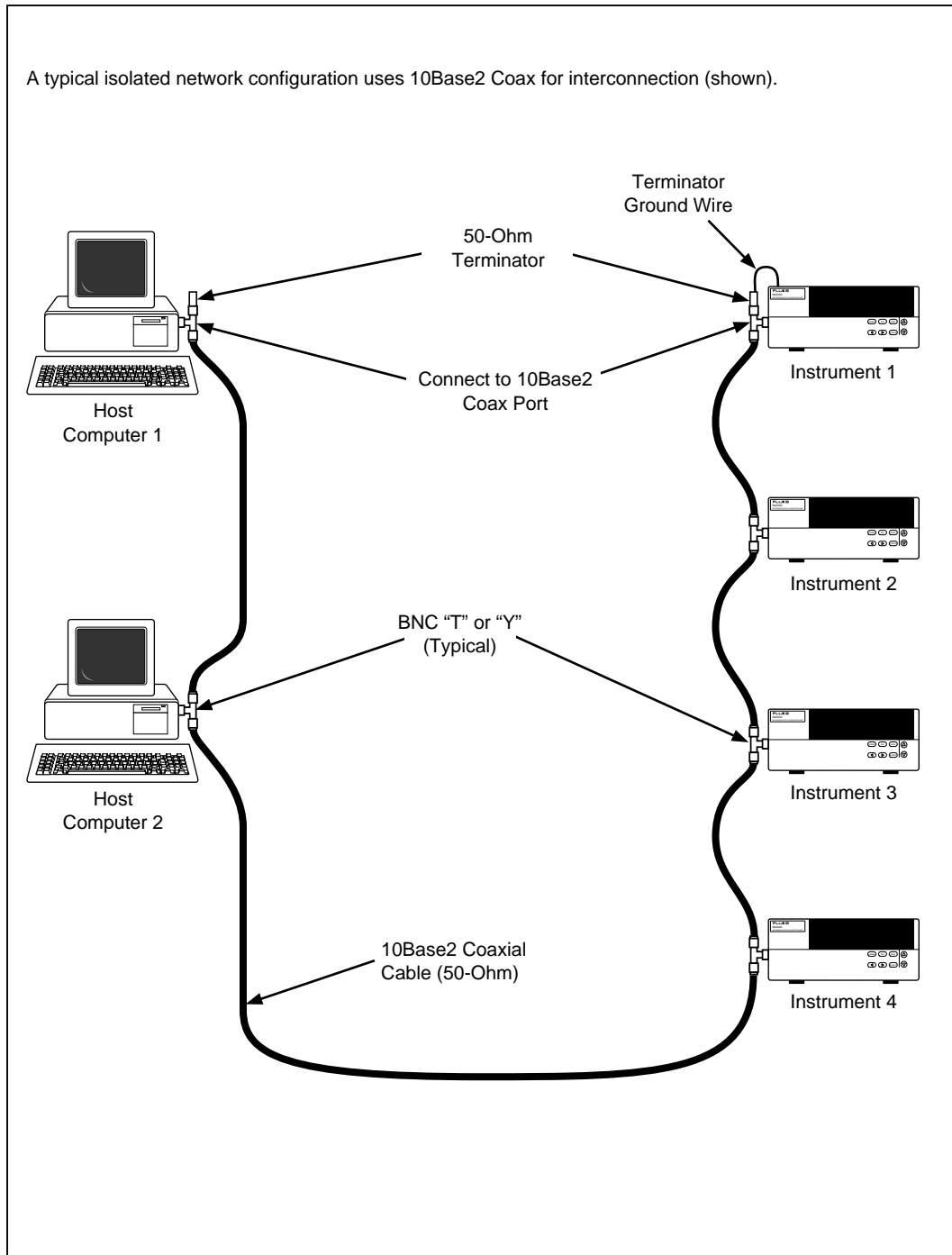

Figure 2-31. Interconnection Using 10Base2 (Coaxial) Wiring

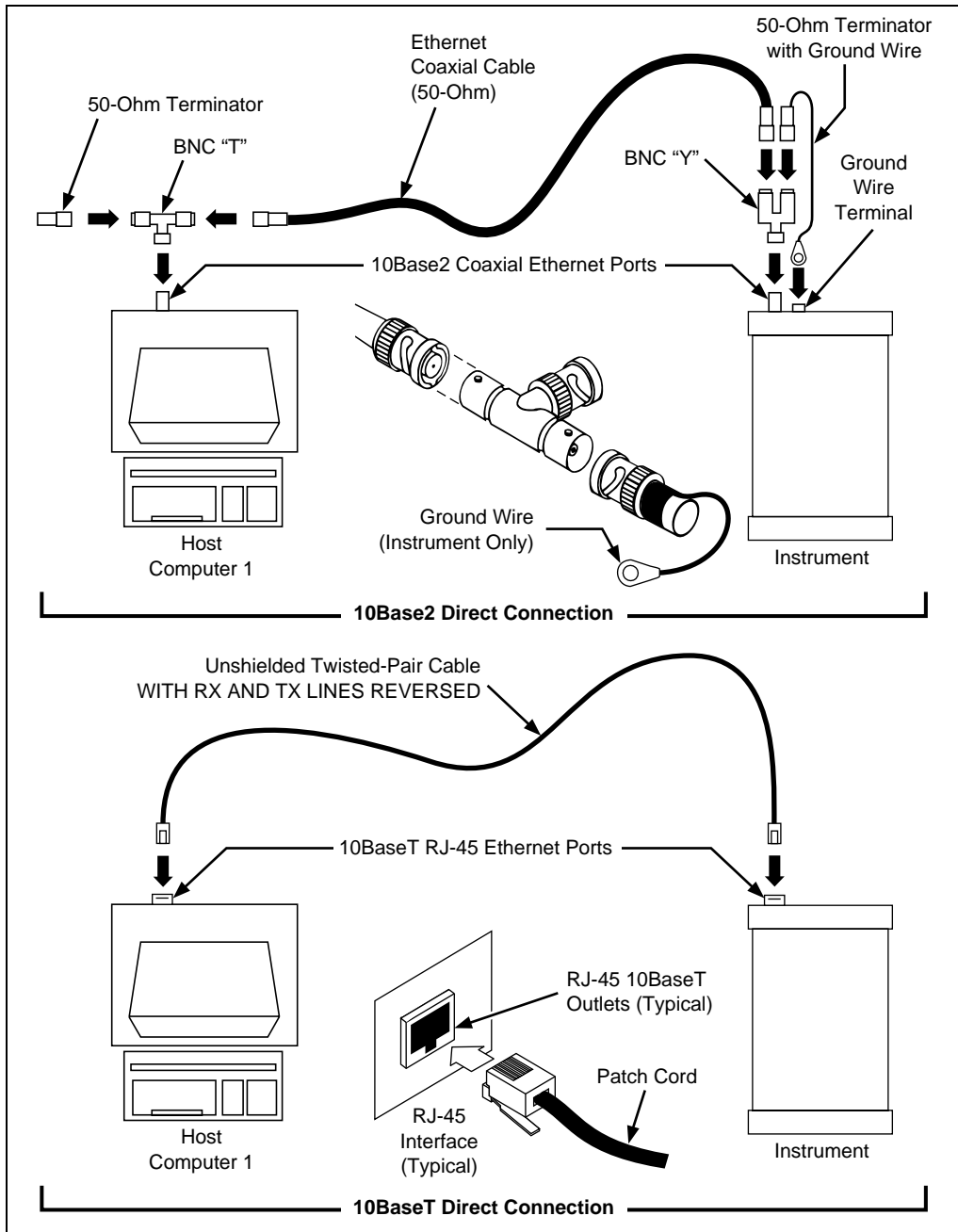

Figure 2-32. Host Computer/Instrument Direct Connection

Interconnection Using 10Base2 (Coaxial) Wiring

2-41.

 **Caution**

Connect the ground lug on the 50-Ohm terminator to the instrument ground terminal only when there is no other shield ground connected for the network.

10Base2 interconnection uses 50-Ohm coaxial cables (Belden 9907 or equal) that loop between equipment items and connect at each station through a BNC "T" or "Y" connector. Each network endpoint terminates into a 50-Ohm load. The minimum distance between BNC T connections is 20 inches (0.5 meter) and the total cable length (without repeaters) must not exceed 600 feet (185 meters).

Complete the following procedure to interconnect the instruments and host computer using 10Base2 coax (Figure 2-31).

1. Connect a BNC T or Y to the 10Base2 port on each instrument and on each host computer.
2. Connect approved Ethernet cables (for example, Belden 9907) with BNC connectors to each BNC T or Y. *Be sure you are using 50-Ohm cable!*
3. Connect 50-Ohm terminators to the BNC T and Y end points. Be sure you have installed 50-Ohm terminations even if there is a direct connection between the host computer and a single instrument. The instrument 50-Ohm terminator at the network endpoint has a ground wire that is connected to the instrument ground terminal (adjacent to the BNC connector) only when there is no other shield ground connected for the network. (See Figure 2-32.)

Interconnection Using 10BaseT (Twisted-Pair) Ethernet Wiring

2-42.

The instruments support connection via twisted-pair Ethernet, usually in conjunction with a "hub" for multiple instruments (See Figure 2-33). Take care that you use twisted pair wires designed for 10BaseT network use (phone cables will not work). Refer interconnection issues to your network administrator. (See Appendix I, "Network Considerations.")

Direct connection between a single host computer and a single instrument with 10BaseT is possible, but you must use a special cable that has its transmit and receive lines crossed. (See Figure 2-32.)

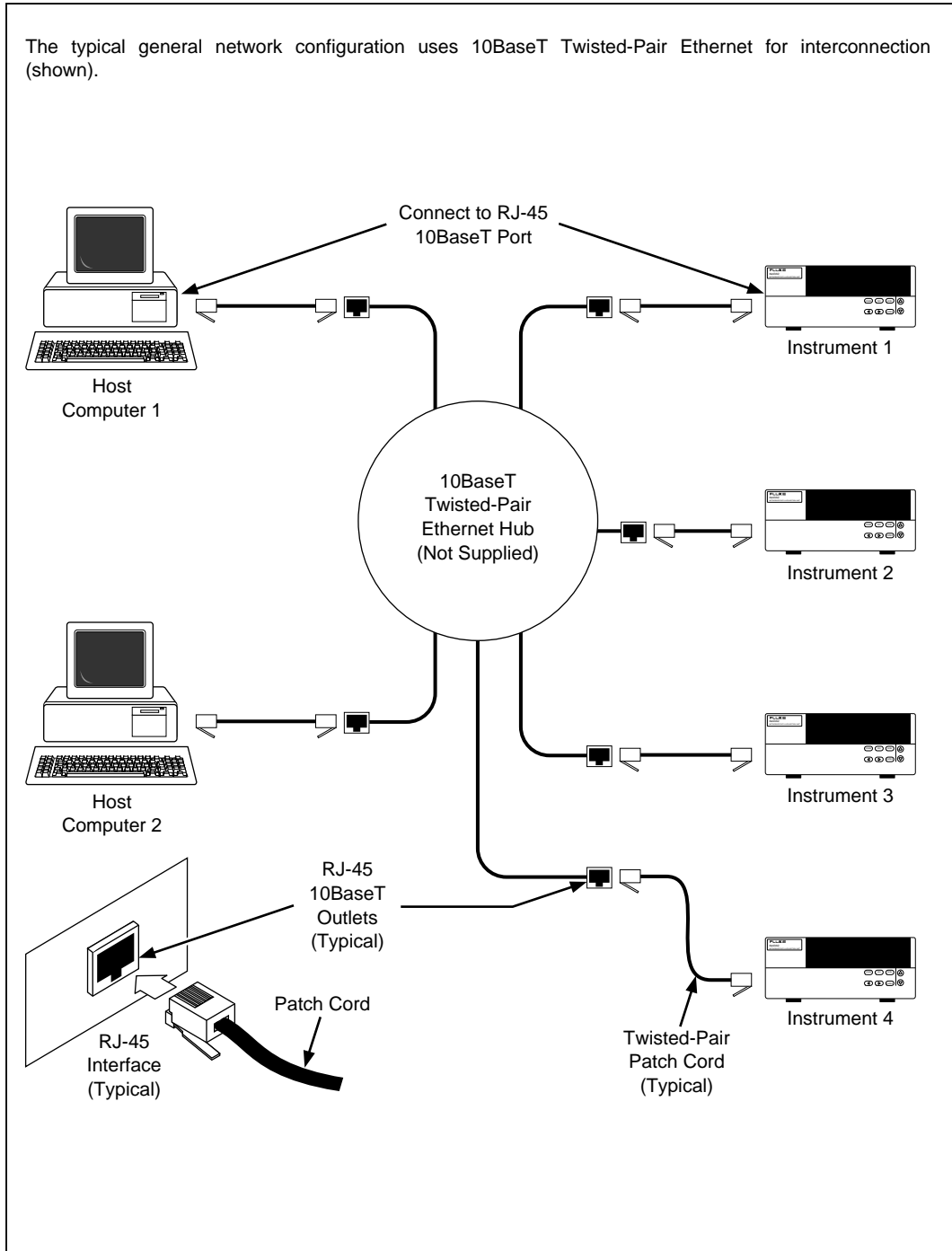

Figure 2-33. Interconnection Using 10BaseT (Twisted-Pair) Wiring

Installing Host Computer Networking Software

2-43.

To establish Ethernet communication in your host computer, you must do the following:

- Install a driver for the adapter
- Install a TCP/IP protocol stack and Windows Socket (Winsock) software
- Set host computer networking parameters

This section discusses installing the adapter driver and the TCP/IP protocol stack and Winsock software. You should install the networking software that is most appropriate for your operating system.

Windows 95 and Windows NT provide drivers for many Ethernet adapters, in addition to the protocol and Winsock software. Users of Windows for Workgroups can get protocol and Winsock software from Microsoft.

For Windows 3.1, use the adapter driver supplied with your adapter. You may also need to install Trumpet or Newt networking software. The NetDAQ Logger installation program can automatically install Trumpet networking software and your adapter driver if you plan to use NetDAQ on an isolated network and your host computer does not already have a TCP/IP stack.

If you are installing NetDAQ Logger for general network operation on a Windows 3.1 host computer, and your computer does not already have an NDIS or ODI adapter driver and TCP/IP and Winsock software, install Newt networking software. See Options and Accessories for ordering information and Appendix I for installation information.

If you plan to install Trumpet networking software, or if your computer is already operating on a network (using the TCP/IP protocol), skip this section. To install Newt networking software (and an appropriate adapter driver) on Windows 3.1, skip this section and see Appendix I.

Complete the following procedure to load the Ethernet adapter driver and the TCP/IP protocol stack and Winsock software on Windows 95. Windows NT installation is similar. The operating system may have already detected the Ethernet adapter and added it. If so, you can skip steps 2 and 3.

1. Open the Control Panel | Network utility via Start | Settings or My Computer.
2. Click Add...; select Adapter, then click Add....
3. Choose the manufacturer and network adapter. Click OK. The support for the adapter gets installed.
4. Click Add..., select Protocol then click Add... Select Microsoft TCP/IP. Click OK. The protocol support gets installed.

Setting Host Computer Networking Parameters

2-44.

This section discusses how to set your host computer networking parameters after you install your adapter and networking software. If you plan to install NetDAQ Logger for general network operation, and you are just now enabling networking, you must set the host computer's IP address, subnet mask, and possibly its default gateway IP address. Obtain this information from your network administrator.

If you plan to install NetDAQ Logger for isolated network operation (without Trumpet), you must set the host computer's IP address to 198.178.246.1xx, and its subnet mask to 255.255.255.0. You can use any numbers for the last two digits of the host computer IP address. Each computer on the network must have a unique number (for example, 198.178.246.101 and 198.178.246.102).

If you plan to install NetDAQ Logger for general network operation and your host computer is already operating on the network, skip this section.

Complete the following procedure to set the networking parameters on Windows 95 or Windows NT:

1. Open the Control Panel | Network utility via Start | Settings or My Computer.
2. Highlight TCP/IP and click Properties.
3. Select the IP Address tab. Enter the IP address and subnet mask. Click OK.
4. If your network administrator supplied a Default Gateway address, select the Gateway tab. Enter the New Gateway address, click Add..., and click OK.
5. Click OK to exit Network Setup.
6. Reboot your computer.

Installing NetDAQ Logger

2-45.

The NetDAQ Logger setup program automatically determines whether to install the 32-bit (for Windows 95 and Windows NT) or 16-bit version of the software. The setup program will ask you to select isolated or general network operation. See “Operating a NetDAQ Data Acquisition System” in Chapter 1 of this manual for information on network type. On Windows 3.1, the setup program will offer you a third option: Isolated Network with Trumpet TCP/IP Stack and Winsock. If you need to install Trumpet, refer to the section “Installing NetDAQ Logger with Trumpet” later in this chapter.

To install NetDAQ Logger, complete the following procedure:

1. Insert Disk 1 and run the setup application (setup.exe). Click Next in the first dialog box.
2. Select Isolated or General Network Type. Click Next.
3. Select the desired destination directory. On 32-bit systems, the default is c:\Program Files\Fluke\netdaq. On 16-bit systems, the default is c:\netdaq. Setup and data file storage defaults to the same directory. Use Browse if you want to change the destination directory.

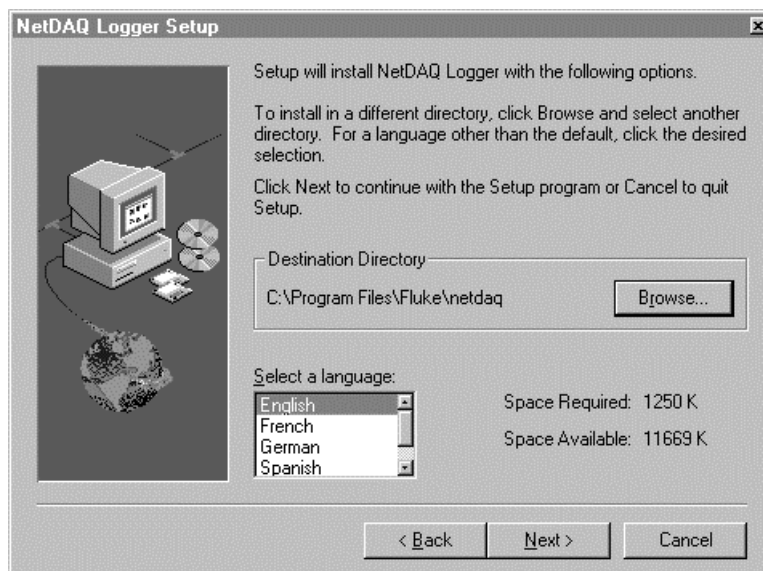

ds305s.bmp

4. Select the language of the user interface: English, French, German, or Spanish. Click Next.
5. Select the program folder. The default name of the program folder or program group is Fluke NetDAQ Logger. You can select or type a different name. Click Next.

6. Check the setup. If the setup is correct, click Next to begin file transfer.
 If you want to change the setup, click Back to go to the appropriate screen and make the changes. Click Next and check the setup again. If it is correct, click Next to begin file transfer.

Installing NetDAQ Logger with Trumpet

2-46.

To install 16-bit NetDAQ Logger and Trumpet, complete the following procedure:

1. Insert NetDAQ Logger Disk 1 and run the setup application (setup.exe). Click Next in the first dialog box.
2. Select Isolated with Trumpet TCP/IP Stack and Winsock Network Type. Click Next.
3. Select the desired destination directory. On 16-bit systems, the default is c:\netdaq. Setup and data file storage defaults to the same directory. Use Browse if you want to change the directory.
4. Select the language of the user interface: English, French, German, or Spanish. Click Next.
5. Select the Ethernet adapter you are using.

Modify the four fields if necessary (see Appendix I for discussion of packet drivers and the other fields).

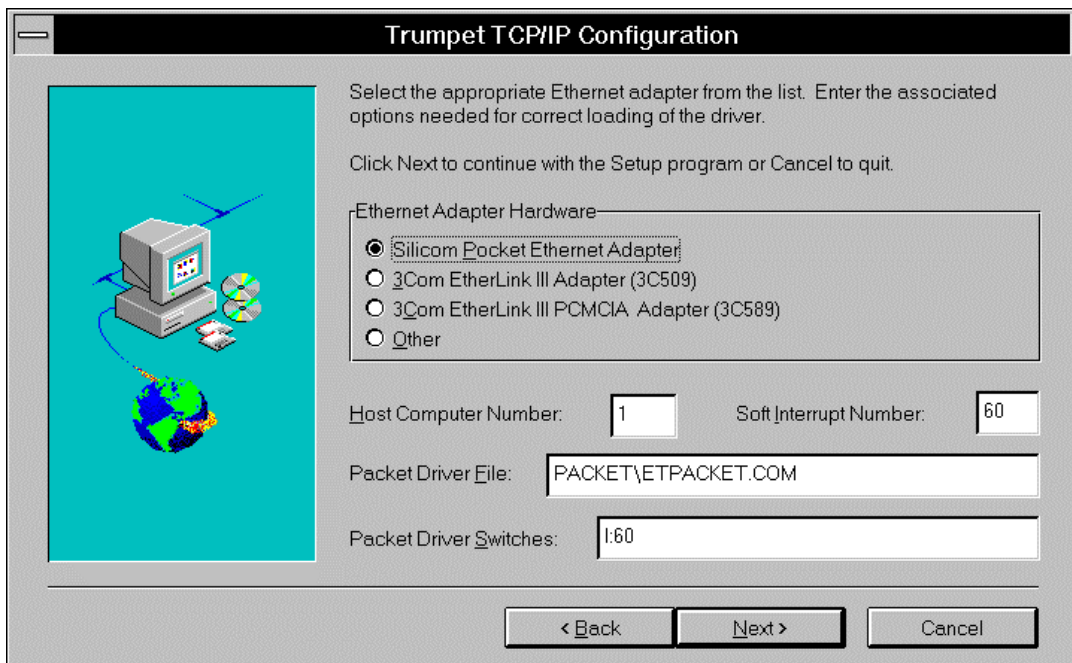

ds307s.bmp

- Tell the setup program whether to modify your autoexec.bat file for the packet driver. Click Next.

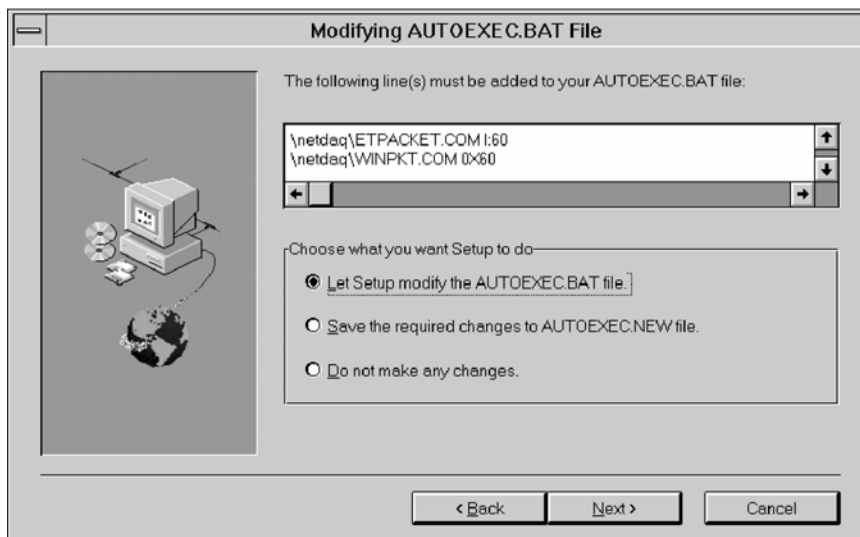

- Select the program folder. The default name of the program folder or program group is Fluke NetDAQ Logger. You can select or type a different name. Click Next.
- Check the setup. If the setup is correct, click Next to begin file transfer.
If you want to change the setup, click Back to go to the appropriate screen and make the changes. Click Next and check the setup again. If it is correct, click Next to begin file transfer.
- After you install NetDAQ Logger with Trumpet TCP/IP software and modify the autoexec.bat file accordingly, reboot your computer to enable networking.

Changing from an Isolated Network to a General Network

2-47.

Use the following procedure to change from an isolated network to a general network:

- To remove your current NetDAQ Logger installation, click the Uninstall icon.
You may want to copy or backup your setup and data files first.
- Reinstall NetDAQ Logger software and select General instead of Isolated.
- Use the front panel procedures discussed earlier in this chapter to set each NetDAQ instrument for general network operation. Also, if necessary, see

“Installing Host Computer Networking Software” and “Setting Host Computer Networking Parameters” to configure the host computer for general network operation.

Installing Trend Link for Fluke (Optional)

2-48.

The Trend Link setup program automatically determines whether to install the 32-bit (for Windows 95 and Windows NT) or 16-bit version of the software. To install Trend Link, complete the following procedure:

1. Insert Disk 1 and run the setup application (setup.exe).
2. After clicking Next to get to the second dialog box, select the language of the User Interface. Click Next.
3. Uncheck components you do not want to install. Use Browse if you want to change the destination directory.
4. Click Disk Space if you want to find a disk with more space. Choosing another disk will change the destination disk. Click Next.
5. Select or type a name if you want to change the Program Folder name. Click Next.
6. Check the installation parameters. If they are correct, click Next to begin file transfer. If you want to change the parameters, click Back to go to the appropriate screen and make the change. Then click Next until the file transfer begins.

If you installed Trend Link in a destination directory other than the default, complete the following procedure in NetDAQ Logger to locate Trend Link:

1. Open the NetDAQ Logger application and select Plot/Trend | Trend Link-Directory.
2. Enter the directory location where you installed Trend Link.

Testing and Troubleshooting

2-49.

Use the following testing procedure to check the operation of the NetDAQ system. Troubleshooting suggestions provide help to identify problems. See Appendix I for additional information.

Testing the Installation

2-50.

This test procedure includes opening NetDAQ Logger, configuring and verifying communications with the instrument, and opening Trend Link.

This procedure assumes that you have performed the following relevant steps described earlier in this chapter:

- Setting line frequency and network parameters on the instrument if the defaults are not applicable
- Installing an Ethernet adapter in your host computer
- Interconnecting the host computer and the instrument
- Installing TCP/IP software
- Installing NetDAQ Logger
- Installing Trend Link (optional)

Complete the following procedure:

1. Open NetDAQ Logger. The default Main Window appears as shown below.

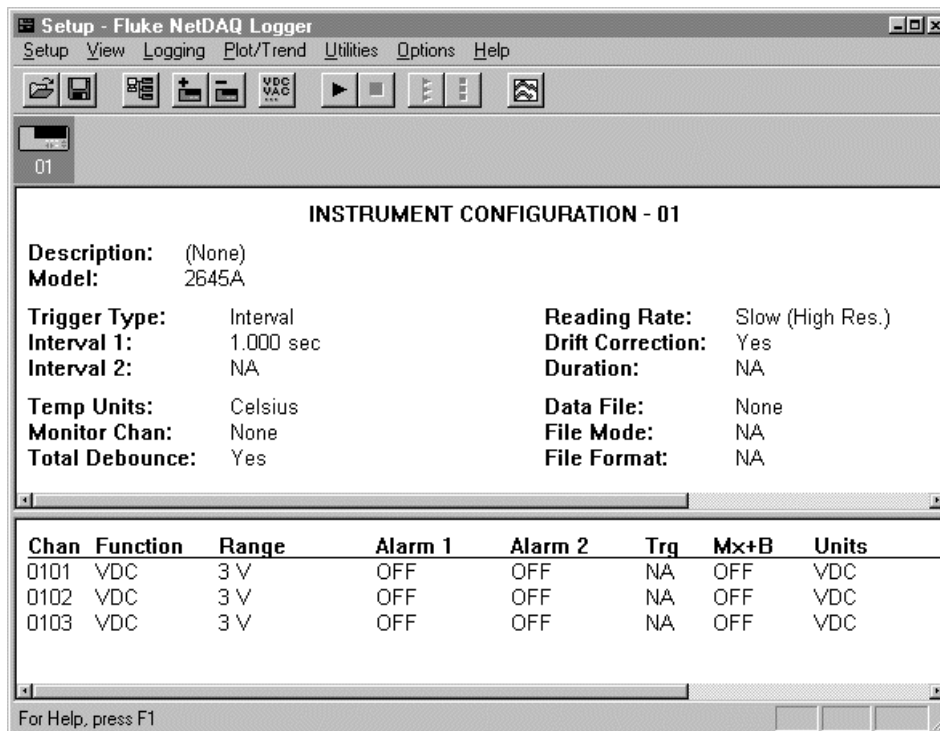

ds302s.bmp

2. Select Setup | Communications Config.
3. Click Add to open the Instruments on Network dialog box to add a NetDAQ instrument to NetDAQ Logger's list of instruments. Select the instrument model number and enter the instrument BCN. On a general network, you must enter the instrument IP address which you previously recorded inside the back cover of this manual. When you finish, click OK. Repeat this step for each instrument you are adding.
4. For a general network installation, click the Socket Port button in the Communications Configuration File dialog box. In the Socket Port dialog box, modify the socket port number if you cannot use the default of 4369 at your installation (see your network administrator if you do not know).
5. Select an instrument from the Instruments on Network list. Click Verify. When the message "Connection Successful!" appears, repeat for the next instrument. Continue until you verify all connections. If any error messages appear, see Troubleshooting Network Problems in the next section.
6. Close the Communications Configuration File dialog box and return to the Main Window.
7. If you installed Trend Link, select Plot/Trend | Show Trend Link. Observe after a few seconds that the Trend Link application appears. In Trend Link, select File | Exit.
8. Refer to Chapter 4 Operating NetDAQ Logger for Windows to place the instrument into operation, or close the application by selecting Setup | Exit Application.

Troubleshooting Network Problems**2-51.**

Review the troubleshooting information below to help locate any network problems. Table 2-4 summarizes network messages reported by NetDAQ Logger for Windows. Table 2-5 is a summary of how to use the Ethernet LED indicators on the instrument to identify network problems. Table 2-6 is a summary of troubleshooting hints for problems not related to error messages or Ethernet indicators.

Table 2-4. Network Error Messages

Reported Message	Comment	Check
Instrument is in use by another PC, or Socket Port number is incorrect!	Each instrument can be controlled by only one host computer.	Verify that socket ports match. See "Setting the Socket Port" in Chapters 2 and 3 of this manual.
Instrument not found!	The instrument did not respond to the host computer.	<p>First, try again. If the message occurs again, verify the following in the order listed:</p> <ol style="list-style-type: none"> 1. Instrument is powered. (The front panel display, when quiescent, shows the instrument BCN.) 2. Instrument is connected to the network. 3. Instrument BCN (displayed on the front panel) matches the BCN displayed on the Instruments on Network list. 4. Network cabling provides a solid connection. 5. Instrument is configured for the correct network type (isolated or general). 6. IP address of instrument matches the IP address displayed on the Instruments on Network list (on a general network). <p>If the problem persists:</p> <ol style="list-style-type: none"> 1. Move the instrument adjacent to the host computer and make a direct connection between the two. See "Host Computer/Instrument Direct Connection" in this chapter.

Table 2-4. Network Error Messages (cont)

Reported Message	Comment	Check
		<p>2. Try Verify Communications. If it still fails, then either the host computer Ethernet adapter is not working or the instrument is defective. If binding errors occurred during booting, see Appendix I for more information. Also refer to "Error and Status Messages" in Appendix J.</p>
<p>Connection is down!</p>	<p>The host computer cannot establish network communication.</p>	<p>1. Make sure the Ethernet adapter driver and TCP/IP software are installed. See "Installing Host Computer Networking Software."</p> <p>2. Make sure the host computer IP address and subnet mask are set properly.</p> <p>3. For an isolated network installation on Windows 95 or Windows NT, the host computer IP address must be 198.178.246.1xx.</p> <p>For a general network installation, you may need to set a default gateway address also. See "Setting Host Computer Networking Parameters" earlier in this chapter.</p>
<p>Unable to initialize Winsock!</p>	<p>The host computer software cannot find or open the Winsock DLL.</p>	<p>Make sure the TCP/IP and Winsock software are installed. See "Installing Host Computer Networking Software" in this chapter.</p>

Table 2-5. Ethernet Indicators

Indicator	Description
Instrument (10Base2 Ethernet)	
XMT (red)	Transmit Blinks when the instrument is transmitting data on the network.
RCV (red)	Receive Blinks when there is any network activity. Steady off means there is no network activity.
LK (amber)	Collision Remains off under normal conditions. The LED blinks when collisions are detected. Steady blinking usually indicates an improperly configured network (no 50-Ohm termination, wrong type of coaxial cable, etc.).
Instrument (10BaseT Ethernet)	
XMT (red)	Transmit Normal indication blinks when the instrument is transmitting data on the network.
RCV (red)	Receive Normal indication blinks when there is any network activity. Steady off means there is no network activity.
LK (amber)	Link Remains on when the instrument connects to a hub or host computer. If off, check the hub connection.
Ethernet Parallel-to LAN Adapter	
Red	Power Lit when power is applied to the adapter. If not lit, check the power connections. This indicator must be on.
Green	Activity Blinks when there is network activity, transmitting and receiving. No blinking when the network is active indicates no connection to the network. Cycle the computer power to activate automatic port selection.

Table 2-6. Troubleshooting

Problem	Discussion
<p>The Ethernet Parallel-to-LAN Adapter is not responding</p> <p>-or-</p> <p>Mouse or Keyboard is not responding, or software behaves abnormally.</p>	<p>If you connect the Ethernet Parallel-to-LAN Adapter to the host computer while the host computer is powered on, the adapter will not initialize correctly. This can cause a variety of unusual conditions. To resolve, power off the computer, check the adapter installation, and restart the computer. Check if the mouse interface is using the same IRQ as the parallel port.</p>
<p>Unable to verify communications with an instrument.</p>	<p>When you select an instrument from the Network list (using Setup Comm Config) to verify communications, you may need to try verification a second time. If this does not clear the problem, see Appendix I for more information.</p>
<p>General Protection Faults.</p>	<p>Acknowledge any General Protection faults, then restart Windows. A General Protection fault can cause unpredictable operation of Windows applications.</p>
<p>Changed instruments on the network and the new instrument do not respond.</p>	<p>If you replace an instrument on your network with the new instrument duplicating the old instrument IP address (general network) or BCN (isolated network), the new instrument may not work.</p> <p>This occurs because the old and new instruments have different Ethernet addresses. When you boot the host computer, the network software links the instrument's IP address and the instrument's Ethernet address (fixed for each instrument). If you change instruments but reuse the IP address (general network) or BCN (isolated network) then the changed instrument may not respond because it has the "wrong" Ethernet address. The solution is to reboot the computer to establish the correct link between the addresses.</p>

Chapter 3

Configuring NetDAQ Logger for Windows

Contents	Page
3-1. Introduction	3-3
3-2. Starting NetDAQ Logger	3-3
3-3. The Main Window	3-3
3-4. Accessing NetDAQ Logger Commands	3-3
3-5. Configuring Network Communications	3-4
3-6. The Communications Configuration Dialog Box	3-5
3-7. Adding an Instrument to the Network.....	3-5
3-8. Deleting an Instrument from the Network	3-7
3-9. Verifying Network Communications.....	3-7
3-10. Configuring the Current Setup	3-8
3-11. Creating an Instrument Icon.....	3-8
3-12. Deleting an Instrument Icon.....	3-9
3-13. Designating Instruments as Group or Asynchronous.....	3-9
3-14. Setup Files	3-11
3-15. Saving the Current Setup in a File	3-11
3-16. Opening a Setup File.....	3-12
3-17. Starting NetDAQ Logger with a Setup File.....	3-13
3-18. Starting Logging Automatically.....	3-14
3-19. NetDAQ Logger Command Line.....	3-14
3-20. Configuring an Instrument	3-15
3-21. Dimmed Configuration Commands	3-15
3-22. The Instrument Configuration Dialog Box	3-15
3-23. Configuring Channels.....	3-18
3-24. The Channels Configuration Dialog Box	3-18
3-25. Configuring Analog Channel Functions	3-19
3-26. Configuring Computed Channel Functions	3-20

3-27.	Defining a Computed Channel Equation	3-20
3-28.	Equation Syntax	3-21
3-29.	Configuring Mx+B Scaling	3-22
3-30.	Configuring Alarms	3-23
3-31.	Assigning Channel Labels	3-24
3-32.	Configuring Mx+B Scaling From a File	3-24
3-33.	Entering an Instrument's Description	3-25
3-34.	Copying a Channels Configuration.....	3-26
3-35.	Default Configuration Settings	3-27
3-36.	Using Configuration Lockout	3-28
3-37.	Saving an Instrument's Configuration as a Text File	3-28
3-38.	Configuring the netdaq.ini File.....	3-29

Introduction

3-1.

NetDAQ Logger provides an easy method for building configuration databases, transferring the configuration to the instrument, collecting data from the instrument, and managing the collected data.

This chapter provides instructions on managing configuration information for NetDAQ Logger. Chapter 4 provides details on operating NetDAQ Logger: starting and stopping the instruments, managing data files, and optimizing performance. For in-depth details of specific topics, refer to the online help available through the Help menu.

Starting NetDAQ Logger

3-2.

NetDAQ Logger is a standard Windows application, and is opened in the same manner as other Windows applications. You can use Start | Programs, double-click on a setup file shortcut on the Windows desktop, or double-click on a setup file name in the Windows Explorer or File Manager.

The Main Window

3-3.

When you open NetDAQ Logger, its Main Window appears, from which you can access all commands and features. The toolbar provides quick access to commonly used commands. The icon bar, below the toolbar, contains a NetDAQ icon for each configured instrument. The icon shows the BCN of the instrument and indicates whether or not NetDAQ Logger is currently logging data from that instrument.

NetDAQ Logger stores instrument configuration information in a setup file. The setup file contains the configuration information for every instrument represented on the icon bar. See “Setup Files” in this chapter for more information. Figure 3-1 shows the Main Window with the setup file setup02 loaded.

The body of the main window shows the instrument configuration for one NetDAQ instrument. If you select the icon for another instrument, the main windows will show its configuration.

Accessing NetDAQ Logger Commands

3-4.

NetDAQ Logger uses standard Windows menus and dialog boxes. This chapter briefly describes the dialog boxes. The online help file has more detail.

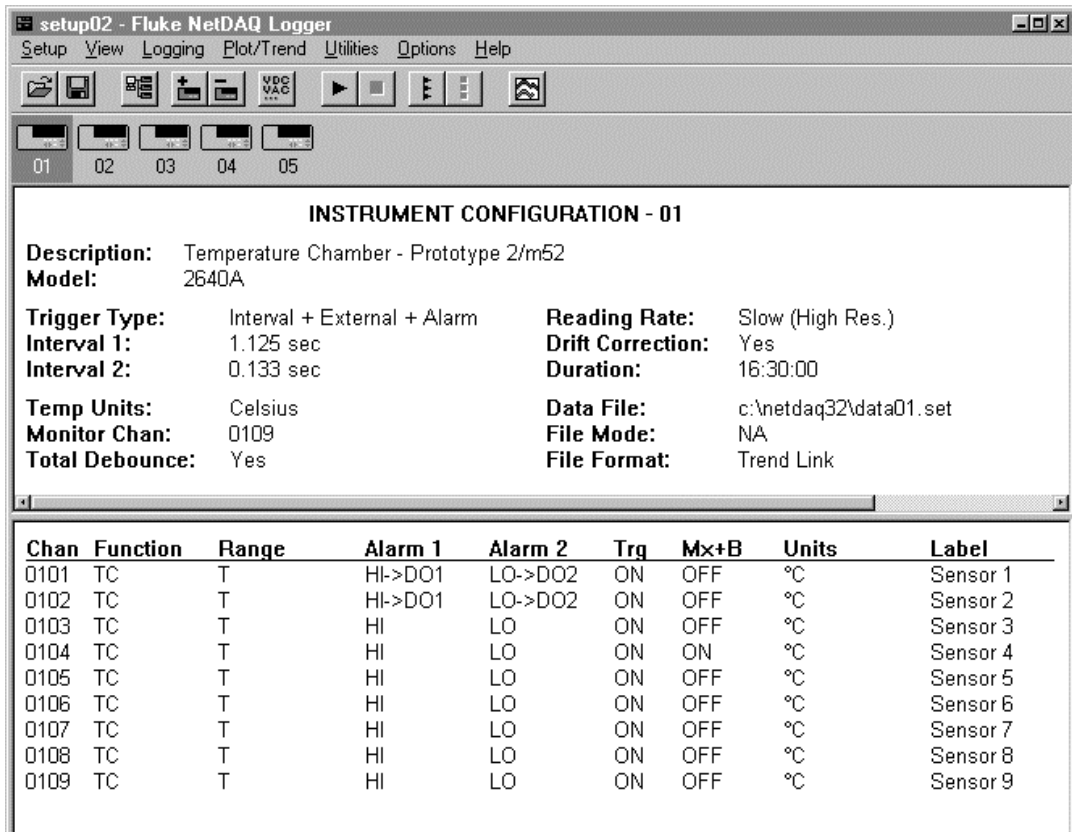

ds002s.bmp

Figure 3-1. NetDAQ Logger Main Window

Configuring Network Communications

3-5.

Before you can configure the instruments on your network and create setup files for these instrument configurations, you must configure your network communications. This involves identifying the instruments by their BCN numbers and, on a general network, their IP addresses.

Network configuration data is *not* saved as part of the setup files but is its own separate file, `ccf.cfg`, maintained by NetDAQ Logger. This file is common to all setup files and any changes you make to the `ccf.cfg` file affect all setup files. Each PC on which you install NetDAQ Logger has a `ccf.cfg` file.

The Communications Configuration Dialog Box

3-6.

Use the Communications Configuration dialog box (Figure 3-2) to record your network configuration.

To open the Communications Configuration dialog box, select Setup | Communications Config or click the Communications Configuration toolbar button.

The dialog box lets you view the instruments currently on the network, modify them, and add or delete instruments.

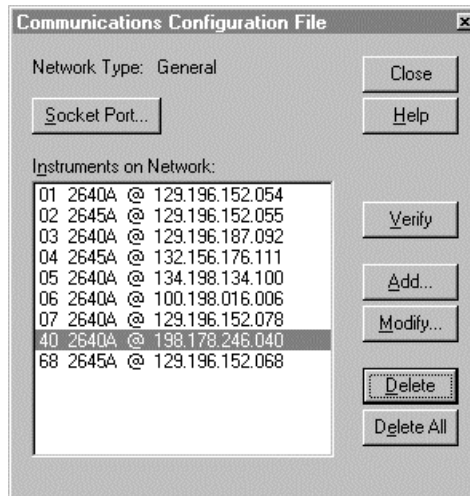

ds009s.bmp

Figure 3-2. Communications Configuration Dialog Box

Adding an Instrument to the Network

3-7.

Complete the following procedure to add an instrument to the Instruments on Network list:

1. Select Setup | Communications Config to open the Communications Configuration File dialog box. Click Add to open the Instrument On Network dialog box.
2. Enter the instrument BCN in the Base Channel Number box. Click the correct model: 2640A or 2645A. For general network operation, enter the instrument IP Address.

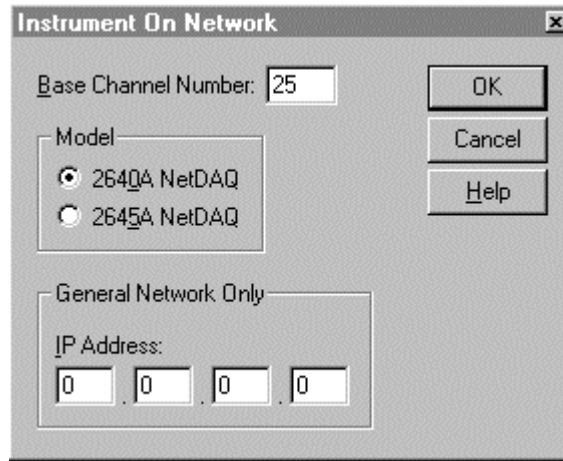

ds007s.bmp

3. Click OK to return to the Communications Configuration File dialog box, which now lists the new instrument. For a general network, the IP address appears after the instrument model number.
4. If you are on a general network, you may need to change the socket port if a conflict occurs with other network operations.

To change the socket port from its default value of 4369, click Socket Port to open the dialog box shown below. The socket port entry must be a number between 1024 and 65535. Click OK when finished.

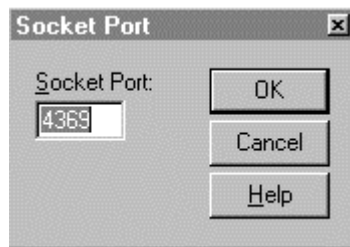

ds010s.bmp

5. Click Close to return to the Main Window.

Deleting an Instrument from the Network

3-8.

Complete the following procedure to remove an instrument from the Instruments on Network List, which is common to all setup files. Any instruments you delete in this procedure will no longer be accessible to any setup file. Do not use this procedure simply to remove an instrument icon from the Icon Bar. To remove an instrument icon, see “Deleting an Instrument Icon.”

1. Select Setup | Communications Config to open the Communications Configuration File dialog box.
2. Highlight the instrument you want to remove.
3. Click Delete to remove a single instrument, or click Delete All to remove all instruments. A warning message appears asking you to confirm whether you wish to delete the instruments.
4. Click Close to return to the Main Window.

Verifying Network Communications

3-9.

Complete the following procedure to verify communications with any instrument on the Instruments on Network List.

1. In the Communications Configuration File dialog box, highlight the instrument you want to verify in the Instruments on Network List.
2. Click Verify. NetDAQ Logger attempts to connect to the instrument and displays a message indicating success or failure.
3. Click Close to return to the Main Window.

Configuring the Current Setup

3-10.

NetDAQ Logger keeps track of all instrument configuration information (e.g., reading rate and measurement functions) for all the instruments represented on the icon bar. This collection of information is called the *current setup*. NetDAQ Logger allows you to save the current setup to a file and open previously saved setup files. You can start up NetDAQ Logger by opening a setup file. You can also set up NetDAQ Logger to automatically load a particular setup file and, optionally, start logging automatically.

When you first start NetDAQ Logger following installation, NetDAQ Logger displays a default current setup. You can add instruments to the setup from the Instrument on Network list (see [Creating an Instrument Icon](#)) and you can delete instruments from the current setup (see [Deleting an Instrument Icon](#)). You can also designate two or more instruments as a group instrument.

After you add an instrument to the current setup, you can set the various configuration parameters for that instrument and you can initiate data logging for that instrument.

After you remove an instrument from the current setup, NetDAQ Logger discards that instrument's configuration information from the current setup. If you add the instrument back to the current setup, it will have default configuration settings.

Creating an Instrument Icon

3-11.

To create an instrument icon, use the following procedure:

1. Select Setup | Create Instrument Icon to open the Create Instrument Icon dialog box. If you receive the message, "No instruments are available for association!" you must first select Setup | Communication Config. to add instruments to the Instruments on Network list. See "Configuring Network Communications" for details.
2. Select the instrument from the Available Instruments list, where the instruments are listed by BCN number. If the instrument you want to add is not listed, then either it already has an icon or it is not on the Instruments on Network List.

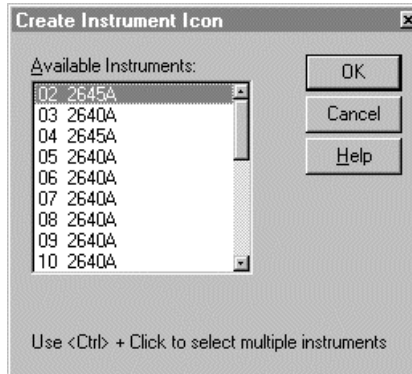

ds004s.bmp

Deleting an Instrument Icon

3-12.

To delete an instrument icon, select Setup | Delete Instrument Icon. A message appears warning you that the instrument’s configuration will be lost. If you choose to delete the icon, it will disappear from the Icon Bar in the Main Window.

Designating Instruments as Group or Asynchronous

3-13.

You can designate instruments as grouped or asynchronous (standalone). NetDAQ Logger treats grouped instruments as one large instrument, logging all their scan data to one data file. A group consists of one Master instrument, and one or more Slaves. Scanning for the entire group is controlled by the configuration of the Master instrument.

For the ASCII and binary file formats, NetDAQ Logger records each Master scan along with the set of scans from the Slave instruments that match closest in time to the Master scan. NetDAQ Logger uses the timestamp for the Master as the timestamp for the whole scan record. NetDAQ Logger can best associate the Slave data with the correct timestamp when scanning for all the grouped instruments is properly synchronized. No merging of data is performed when recording in the TL format but proper synchronization is still important for accurate correlation of data between instruments. Use the following guidelines to minimize non-synchronization errors.

- Wired Group

To reliably synchronize a group instrument, connect the TO (Trigger Out) line of the Master to the TI (Trigger In) of each Slave (along with a common connection to the ground terminals). Check the “Group is Externally Wired” check box in the Group Instruments dialog box. See “External Wiring for a Group Instruments” in Chapter 2 of this manual.

When a grouped instrument is externally wired, you can select any combination of trigger types for the Master instrument: Interval Trigger, External Trigger, or Alarm Trigger. NetDAQ Logger configures the Slaves for External Trigger so they will respond to the trigger signal from the Master.

- Unwired Group

If you cannot wire the grouped instrument, select only the Interval Trigger for the Master. NetDAQ Logger automatically sets all Slaves to use the Interval Trigger with the same Interval 1 value as the Master. If any additional trigger types are selected for the Master, then additional scans might be triggered in the Master that are not triggered in the Slaves. This could cause Slave scan data to be duplicated with more than one Master scan.

To use this method, uncheck the “Group is Externally Wired” check box in the Group Instruments dialog box.

To designate a group instrument, complete the following procedure:

1. Select Setup | Group Instruments to open the Group Instruments dialog box.

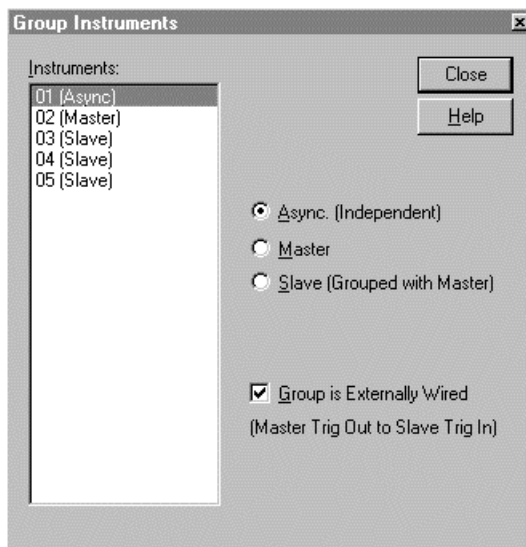

ds016s.bmp

2. From the Instruments list, designate each instrument as Master, Slave, or Asynchronous:
 - Highlight the Master instrument and select the Master button. Designate the Slaves in a similar fashion. Check the Group is Externally Wired box if applicable.
 - Highlight the independent instruments, and select the Async button.

Setup Files

3-14.

NetDAQ Logger allows you to save the current setup in a file. You can open the setup file later to reestablish the saved setup. Using setup files, you can create any number of setups in advance and use them when applicable.

You can set up your system so that you can activate NetDAQ Logger by opening a setup file. With the Windows 95 user interface, you can create shortcuts to setup files. With the Windows 3.1 user interface, you can associate setup files (.stp file extension) with NetDAQ Logger.

You can use command line arguments for NetDAQ Logger so that, when activated, NetDAQ Logger automatically opens a specified setup file. You can also set it up to start logging when activated.

Saving the Current Setup in a File

3-15.

Each time you change an instrument's configuration, you change the current setup. You can save these changes to a setup file. If you want to retain the old configuration, you can save the current setup under a new name, thereby creating a new file, leaving the old one intact.

- To save the current setup to the setup file of the same name, select Setup | Save Setup or click the Save Setup toolbar button. If the file does not exist, a standard Windows Save Setup As dialog box appears permitting you to enter the file name.
- To save the current setup to a new file, select Setup | Save Setup As. Enter the desired setup name in the File Name box and modify the directory path as required. (For example, setup04.stp as shown below.) Click Save.



ds039s.bmp

Opening a Setup File

3-16.

If NetDAQ Logger is already active, you can load a saved setup into the current setup by opening a setup file. Before you open a setup file, you must stop logging on all instruments. Use any of the following methods to open a setup file.

- Select Setup | Open Setup to open the Open Setup dialog box. Highlight the desired setup file from the list of file names, or enter the file name in the File Name box and click on Open.
- If the desired setup file has been opened recently, you can simply select its name in the Setup menu's list of recently used files.
- On Windows 95, if you have created a shortcut for the desired setup file, you can drag the shortcut from the Desktop into NetDAQ Logger to open the setup file.



ds001s.bmp

Starting NetDAQ Logger with a Setup File

3-17.

On Windows 95, there are several ways to start NetDAQ Logger and open a specific setup file at the same time:

- In the Windows Explorer or My Computer, you can double-click on the name of the desired setup file. You must start NetDAQ Logger itself once after installation before you can start it via a setup file.
- You can double-click on a shortcut to a setup file which you have previously placed on the Desktop. To create a shortcut in Windows Explorer, complete the following procedure:
 1. Highlight the setup file name and use the right mouse button to create a shortcut.
 2. Drag the shortcut to the desktop. You must start NetDAQ Logger itself once after installation before you can start it via a setup file shortcut.
- You can create a shortcut to NetDAQ Logger, place it on the desktop, and modify the command line in its properties to open a setup file (see “NetDAQ Logger Command Line” for the command lines). You can then double-click on the shortcut icon to start NetDAQ Logger. To create and modify the shortcut, complete the following procedure:
 1. Highlight the NetDAQ executable file in the Windows Explorer and use the right mouse button to create a shortcut.
 2. Drag the shortcut to the Desktop and use the right mouse button to access its properties.

3. On the **Shortcut** tab, add the setup file name to the end of the command line in the **Target** box (see “NetDAQ Logger Command Line” for the command lines).
- You can use **Start | Settings | Taskbar** to modify the command line of NetDAQ Logger to open a setup file whenever you start NetDAQ Logger from **Start | Programs**. Complete the following procedure:
 1. In the **Taskbar Properties** dialog box, select the **Start Menu Programs** tab and click **Advanced**.
 2. Find and highlight the **NetDAQ Logger** shortcut and use the right mouse button to access its properties.
 3. On the **Shortcut** tab, add the setup file name to the end of the command line in the **Target** box (see “NetDAQ Logger Command Line” for the command lines).

On Windows 3.1, you can start NetDAQ Logger with a setup file as follows:

- You can double-click on a setup file name in the **File Manager**. Before this will work, you must start NetDAQ Logger itself once after installation (from **Program Manager** or **File Manager**) and associate the .stp file extension with NetDAQ Logger. To associate the .stp file extension, use **File Manager** to highlight a setup file. Select **File | Associate** and click on **Browse** to enter the location of the NetDAQ Logger executable.
- You can modify the command line of NetDAQ Logger so that it will always open a particular setup file when started from **Program Manger** or **File Manager** (see “NetDAQ Logger Command Line” for the command lines). To modify the command line, highlight the NetDAQ Logger icon in **Program Manager**, select **File | Properties**, and change the command line.

Starting Logging Automatically

3-18.

In addition to naming a setup file for NetDAQ Logger to open automatically, you can set a flag telling NetDAQ Logger to start logging automatically for all instruments in the setup. Use the methods described above to modify the command line and add the /g flag as shown below.

NetDAQ Logger Command Line

3-19.

The command line for activating NetDAQ Logger has the following format. For the 16-bit version, the executable name is netdaq as opposed to netdaq32. On Windows 3.1, the executable name and setup file do not have quotation marks.

```
"pathname\netdaq32" ["setupfilename"] [/g] [/c]
```

To activate NetDAQ Logger with the default setup:

```
"pathname\netdaq32"
```

To activate NetDAQ Logger with a specific setup file (for example, mysetup.stp):

```
"pathname\netdaq32" "mysetup.stp"
```

To activate NetDAQ Logger with a specific setup file and start logging automatically:

```
"pathname\netdaq32" "mysetup.stp" /g
```

To add calibration to the Utilities menu of NetDAQ Logger:

```
"pathname\netdaq32" /c
```

Configuring an Instrument

3-20.

Once you have set up the network list, and created icons and grouped instruments necessary for your setup, you can configure the instruments or instrument group.

You can set instrument-level parameters such as reading rate and trigger types, and channel parameters such as function, Mx+B scaling, and alarms.

All configuration operations apply to the instrument which is selected on the icon bar.

Dimmed Configuration Commands

3-21.

Some operations in NetDAQ Logger are mutually exclusive. When a command is unavailable, its menu entry or toolbar icon will be grayed out. For example you cannot configure an instrument while it is scanning. Also, checking the Configuration Lockout command in the Options menu prevents you from modifying the configuration.

The Instrument Configuration Dialog Box

3-22.

All instrument configuration procedures start with the Instrument Configuration dialog box shown in Figure 3-3. When you create a new instrument icon, this dialog box shows the default configuration settings.

Open the Instrument configuration dialog box by double-clicking anywhere in the Instrument Configuration area of the Main Window (the upper portion), pressing the Instrument Configuration toolbar button or selecting Setup | Instrument Configuration. Complete the following procedure to configure the instrument.

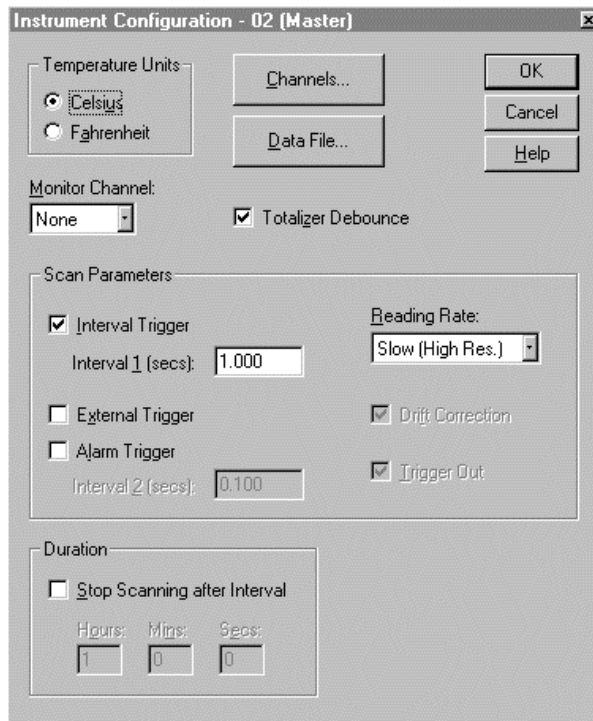

ds017s.bmp

Figure 3-3. Instrument Configuration Dialog Box

1. Select Celsius or Fahrenheit to use as temperature units for thermocouple and RTD temperature measurements.
2. Select a monitor channel. This channel will automatically be displayed on the instrument's front panel when logging is started.
3. Check Totalizer Debounce to prevent false counts that can occur when the Totalizer input is from contact closures.
4. Select the desired trigger types and enter intervals in seconds (00000.000 to 86400.000).

The NetDAQ instrument performs a scan when it detects a trigger event. The source of the trigger event depends on the combination of trigger types configured in the instrument. The characteristics for each trigger type and trigger type combination are as follows.

- Interval Only

A scan is triggered immediately after logging starts. Each successive scan is triggered after Interval 1 elapses since the start of the previous scan.

- External Only

A scan is triggered immediately after the external trigger input is pulled low (active). While the external trigger line remains low, each successive scan is triggered after Interval 2 elapses since the start of the previous scan.

- Alarm Only

A scan is triggered when the instrument detects an alarm condition on a channel being used as an alarm trigger. As long as at least one alarm trigger channel is in alarm, each successive scan is triggered after Interval 2 has elapsed. The instrument performs background scanning of alarm trigger channels, according to Interval 5, until it detects an alarm condition. The Alarm Checking Interval (Interval 3) is configurable in the netdaq.ini file. Defaults are 1 second (2640A) and 0.1 second (2645A).

When the external trigger is combined with the alarm trigger, scans are triggered at the Interval 2 rate as long as either the external trigger line is low or at least one alarm trigger channel is in alarm.

When the interval trigger is combined with the external trigger and/or the alarm trigger, scans are triggered at the Interval 2 rate when the conditions are met for the external trigger and/or the alarm trigger, and at the Interval 1 rate at all other times.

5. Select the slow reading rate for high precision, the fast reading rate for high speed, or the medium reading for a balance of the two. The actual number of readings per second depends on the selected functions.
6. Enable Drift Correction to have the instrument automatically correct measurements for drift due to changes in instrument temperature and humidity. You can disable Drift Correction to obtain a faster scan rate when you have set the reading rate to fast, but this may reduce long-term accuracy.
7. Enable Trigger Out (TO) to have the instrument set the rear-panel TO line to logic low for 125 μ s each time a scan starts. Disable Trigger Out if you are not using it so that the instrument may achieve maximum scanning speeds. NetDAQ Logger automatically enables the trigger out when an instrument is the Master of an externally wired group.
8. Enable and enter a value for the duration if you would like NetDAQ Logger to automatically shut down logging for the instrument after the specified time has elapsed since the start of logging.

Configuring Channels

3-23.

These procedures provide instructions for configuring an instrument's analog channels and computed channels. These instructions include selecting the measurement function, enabling Mx+B scaling, configuring alarms, and entering channel labels.

The Channels Configuration Dialog Box

3-24.

All channels configuration procedures start with the Channels Configuration dialog box shown in Figure 3-4.

To open the Channels Configuration dialog box, click Instrument Configuration | Channels or double-click anywhere in the Channels Configuration area of the Main Window (the lower portion).

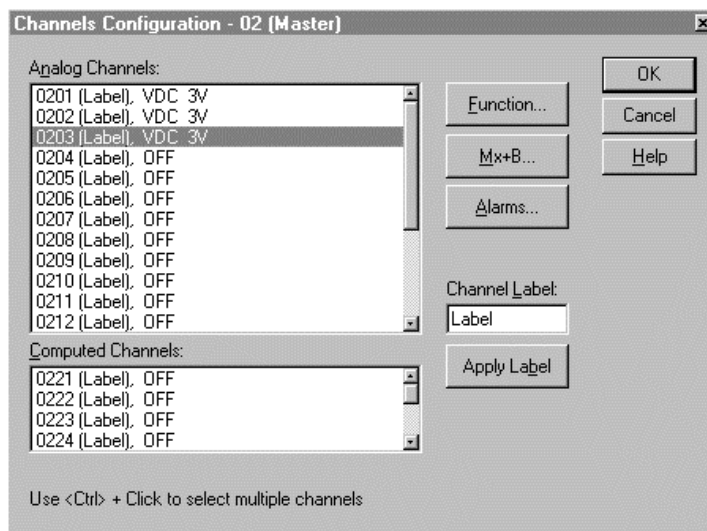

ds020s.bmp

Figure 3-4. Channels Configuration Dialog Box

Configuring Analog Channel Functions

3-25.

Analog channel functions include volts dc, volts ac, ohms, temperature (thermocouple and RTD), frequency, and dc current. To configure analog channel functions, complete the following procedure:

1. Select an analog channel in the Channels Configuration dialog box.
2. Click Function to open the Function Selection dialog box.
3. Select the function and range. If desired, enter a custom nine-character Units Label. The default units are VDC, VAC, Ohms, °C or °F, Hz, Amps (0-100 mA current range), and Percent (4-20 mA current range).

If the function is Current, you can enter the resistance of the current shunt. The range is 10 to 250 Ohms and the default is 10 Ohms. If the function is RTD-2W or RTD-4W, you can enter R0, the RTD Ice point. The range is 10 to 1010 Ohms and the default is 100 Ohms. If the range is Custom-385, you can enter the RTD probe constant, Alpha. The range is 0.00374 to 0.00393 and the default is 0.00385055 . See Appendix D for more information.

If the function is TC, you can check Open Thermocouple Detect. If selected, the instrument monitors thermocouple continuity. If continuity is lost, otc appears on the instrument front panel during monitor for the thermocouple, “Open TC” appears in the Spy and Quick Plot windows, and the data file records the value 9.0E+9. If not selected, an open thermocouple may result in +OL on the instrument front panel during monitor. “+Overload” appears in the Spy and Quick Plot windows and the data file records the value 1.0E+9.

4. Click OK.

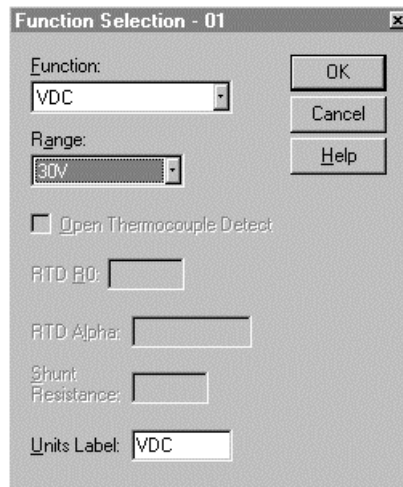

ds018s.bmp

Configuring Computed Channel Functions

3-26.

Computed channel functions include average, difference, difference from average, and equation. To select computed channel functions, complete the following procedure:

1. Select a computed channel in the Channels Configuration dialog box.
2. Click Function to open the Computed Function dialog box.
3. Select the function, the channels, and, if desired, a custom Units Label. For example, averaging analog channels 1 and 2 is as shown below.
4. Click OK.

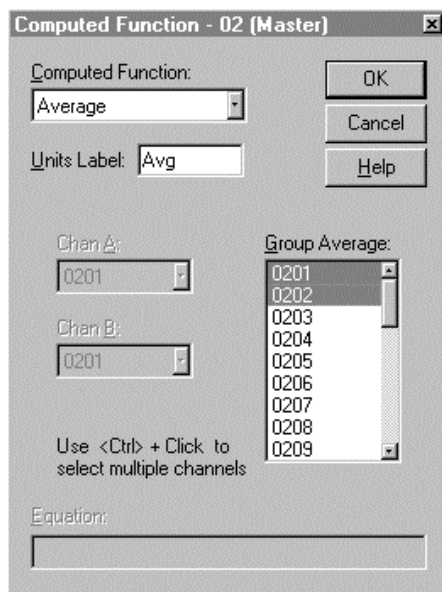

ds019s.bmp

Defining a Computed Channel Equation

3-27.

To define a mathematical equation for a computed channel, complete the following procedure:

1. In the Equation field at the bottom of the box, enter the equation. See “Equation Syntax” for information on entering equations.
2. Click OK to store the equation and return to the Channels Configuration dialog box.

3. If the equation contains an error, an error message appears. Click OK in the error message box. If possible, NetDAQ Logger highlights the location of the error in the equation. Change the equation as necessary and click OK to return to the Channels Configuration dialog box.
4. Click OK to return to the Instrument Configuration dialog box.
5. If all of the defined equations for this instrument exceed the allowed storage space (1000 bytes), an error message appears. If this happens, reopen the Functions dialog box and redefine or eliminate equations as necessary.

Equation Syntax

3-28.

Use the following guidelines to define new equations or modify existing ones.

Each equation can be up to 100 characters in length, and each must include a reference to at least one other configured channel. Examples of equations are shown below:

$$(-2*c21/c2)/(2*(1.32-(c21/c2)*1.32))$$

$$20 * \log(C1/C2)$$

Operands can be integer or real constants, or analog or computed channels. Each channel reference contains the letter 'c' followed by a one-or-two-digit channel number. All referenced channel numbers must be lower-numbered than the channel being defined.

Examples of operands are shown below. (The decimal point character corresponds to your Windows International settings.)

1.5e5	c21
-32.407	C1
2.57E-3	c02

Operations are computations or functions performed on the operands. Refer to the allowed operations below, shown in order of increasing precedence. Operators in the same row have the same precedence.

+ -
* /
**

unary + unary - abs exp int ln log sqr

Delimiting the argument of a function requires parentheses. Use them also to enforce, override, or clarify precedence. You may nest up to three sets of parentheses. The following examples demonstrate proper and improper use of nested parentheses:

Allowed

$$(-2*c21/c2)/(2*((c1+1)-(c21/c2)*(c1-1)))$$

See Appendix E for syntax definition and more detailed information.

Not Allowed

$$(-2*(abs(c1/(c2-c3))))$$

Configuring Mx+B Scaling**3-29.**

Mx+B scaling multiplies a measurement by a multiplier (M) and then applies an offset (B). For example, Mx+B scaling of 100x+50 applied to a measured value of 1.15 would result in a reading of $100(1.15)+50=165$.

You can configure both analog and computed channels to use Mx+B scaling.

You can save values for M and B in a separate file and load directly from the file using Setup | Load Mx+B File. See “Configuring Mx+B Scaling from a File” for more information.

To configure Mx+B scaling, complete the following procedure:

1. Select the desired channels and click the Mx+B button to open the Mx+B Configuration dialog box. Enter the M and B values.

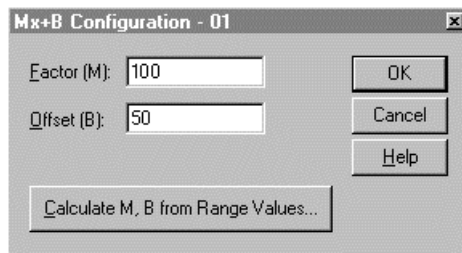

ds023s.bmp

2. To have NetDAQ Logger calculate the Mx+B values, click Calculate M, B from Range Values, and enter the input and scaled range values. Click OK.

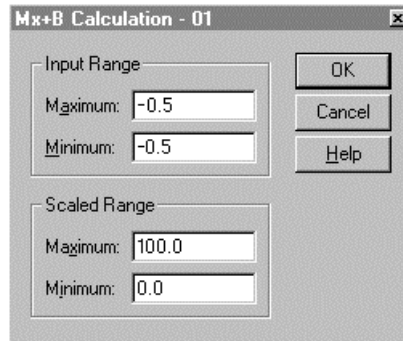

ds024s.bmp

Configuring Alarms

3-30.

Each channel has two alarms, each of which may be set to HI, LO, or OFF. An alarm condition occurs when a measurement falls below a low alarm value (LO alarm) or rises above a high alarm value (HI alarm). NetDAQ Logger records all alarm conditions in the data file.

If a channel is configured for Mx+B scaling, the instrument will scale the measurement values before comparing that to the alarm limits.

To configure alarms, complete the following procedure:

1. Select the desired channels and click the Alarms button to open the Alarms Configuration dialog box.

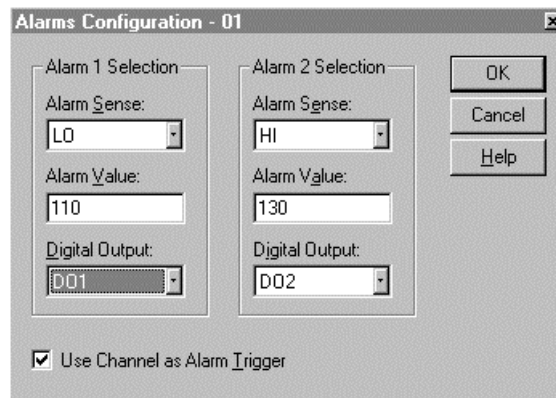

ds025s.bmp

2. Set each alarm to HI, LO, or OFF and enter alarm values.

3. Select a digital output if you would like to associate an alarm with a digital I/O line. The instrument will set the digital I/O line to a TTL logic low for as long as the alarm conditions is met.
4. Check Use Channel as Alarm Trigger if you would like an alarm condition on this channel to trigger scanning. (Alarm Trigger must also be enabled in the Instrument configuration dialog box.)

Assigning Channel Labels

3-31.

To assign a label for any channel, highlight a channel, type a label (15 characters maximum) in the Channel Label field, and click Apply Label.

Channel labels appear in the Main Window, the Spy Channel Selection dialog box, Quick Plot Setup, Quick Plot window, and Trend Link chart.

Configuring Mx+B Scaling From a File

3-32.

Complete the following procedure to load Mx+ B values from a file into the current setup for the selected instrument.

1. Select the desired instrument icon on the Icon Bar.
2. Select Setup | Load Mx+B File to open the Load Mx+B File dialog box.
3. Select the desired Mx+B file from the File Name list, or enter the file name in the File name box. Modify the directory path as required. For example, select `mxb01.txt` as shown below:

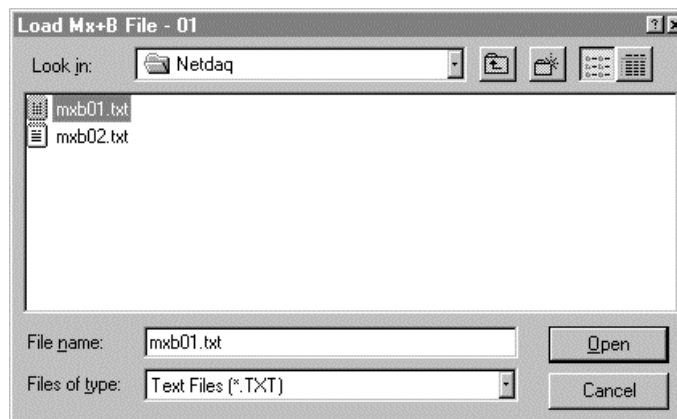

ds006s.bmp

4. Click Open to load the file and return to the Main Window. The Mx+B status of the Channels Configuration area of the Main Window will be updated accordingly.

The values in the Mx+B file must have the following format:

```
<channel number> <M value> <B value> <cr> <lf>
```

Each parameter is separated by spaces or tabs and each definition ends with a carriage return (<cr>) and a line feed (<lf>). The decimal point character corresponds to your Windows International settings. For example, a file may contain the following lines:

```
2 1.8 32
10 2 1
```

This sample file indicates that, for the instrument selected on the Icon Bar, channel 2 has its M value set to 1.8 and its B value set to 32. Channel 10 of the currently selected instrument has its M value set to 2 and its B value set to 1.

M and B values are not set if the corresponding channel is configured as OFF.

If an error occurs when loading the Mx+B file, NetDAQ Logger displays an error message and does not load any values for M and B. If possible, the error message displays the line where the error occurred.

After loading the file, NetDAQ Logger sets M and B values for the channels of the instrument currently selected on the Icon Bar.

Entering an Instrument's Description

3-33.

If you provide a textual instrument description, it will appear in the Main Window. Complete the following procedure to enter an instrument description. Up to 79 characters are allowed.

1. Highlight the desired instrument icon on the Icon Bar.
2. Select Setup | Instrument Description.
3. Enter the text characters in the Description box as shown in the following example.

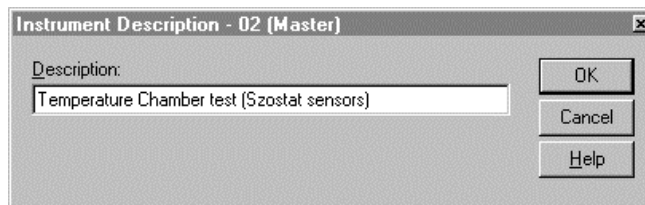

ds033s.eps

4. Click OK to return to the Main Window that now includes the instrument description.

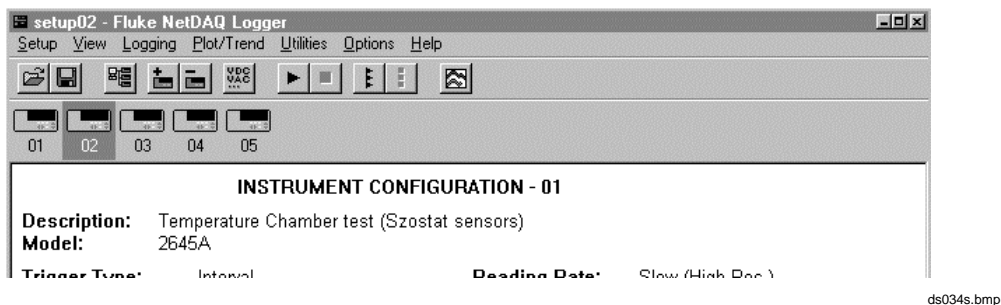

Copying a Channels Configuration

3-34.

Complete the following procedure to copy a complete instrument channels configuration from one instrument to another instrument. This includes channel Functions, Mx+B Scaling, Alarms, and Channel Labels. For example, if you set up three instruments with identical channel configurations, you can configure one instrument and then copy the channels configuration to the other two instruments.

1. Highlight the icon of the source instrument on the Icon Bar.
2. Select Setup | Copy Channels to open the Copy Channels dialog box.
3. Select the destination instrument(s) from the Copy Channels To list. For example, to copy the channels configuration of instrument 02 to instruments 01 and 03, select instrument 02 as the source instrument (Step 1), then select instruments 01 and 03 in the Copy Channels dialog box (below).

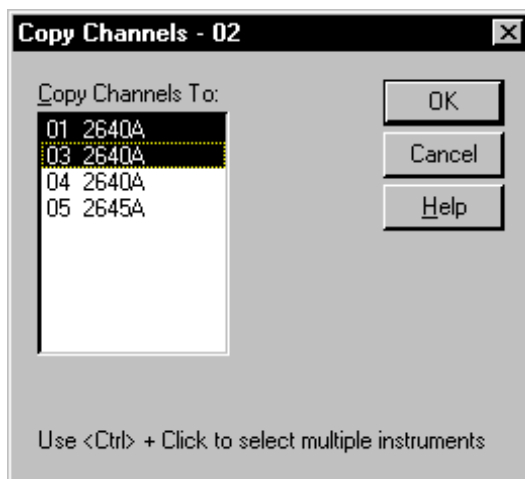

4. Click OK to copy the configuration and return to the Main Window.

Default Configuration Settings

3-35.

When you create a new instrument icon, NetDAQ Logger initializes the settings for that instrument to the default parameters. (See Table 3-1.)

Table 3-1. NetDAQ Logger Default Instrument Configuration

Parameter	Default Values
Description:	None
Group Status:	Asynchronous
Trigger Type	Interval Trigger
Interval 1:	1 sec
Interval 2:	0.1 sec
Reading Rate:	Slow (High Res)
Drift Correction:	Enabled
Trigger Out:	Disabled
Duration:	Disabled (Infinite)
Temperature Units:	Celsius
Monitor Chan:	None
Totalizer Debounce:	Yes
Data File:	None
File Comment:	None
File Mode:	Append
File Rollover:	None
Low Disk Space:	Rollover on 1000K bytes
Deadband Values:	All Zero
Batch Name:	None (file name is used)
Batch Definition:	Entire logging session
Channels:	Channels 1-3: VDC 3V Channels 4-30: OFF
MX+B:	All Off
Alarms	All Off

Using Configuration Lockout

3-36.

Use The Configuration Lockout feature to prevent accidental instrument configuration changes. The following commands in the Setup menu will be disabled: Create Instrument Icon, Delete Instrument Icon, Group Instruments, Communications Config, Instrument Description, Instrument Configuration, Load MxB+ File, and Copy Channels.

Select Options | Configuration Lockout to toggle this feature on and off.

Saving an Instrument's Configuration as a Text File

3-37.

Complete the following procedure to save the instrument configuration displayed in the Main Window as a text file. NetDAQ Logger cannot load configuration data from a configuration text file.

1. Highlight the desired instrument icon on the Icon Bar. The instrument's configuration appears in the Main Window.
2. Select Setup | Save Inst. Config. Text to open the Save Instrument Configuration Text dialog box shown below.

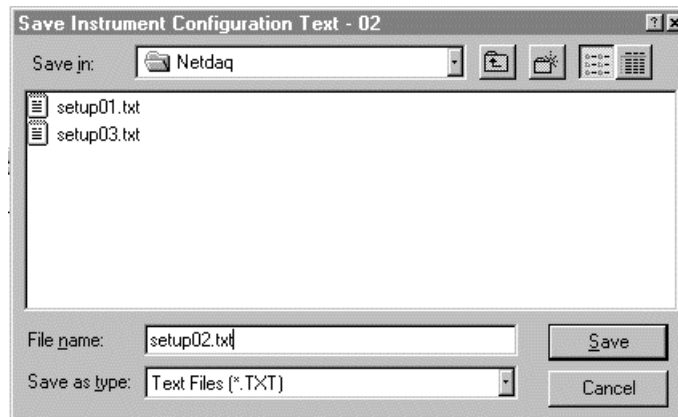

ds040s.bmp

3. Enter the desired text file name in the File Name box and modify the directory path as required. Click Save.

The configuration file is now saved as an ASCII text file. You can open the text file for viewing or printing from an application such as Notepad. Refer to Figure 3-5 for a typical text file.

```

INSTRUMENT CONFIGURATION - 02

Description:      (None)
Model:           2640A
Trigger Type:    Interval
Interval 1:      1.000 sec
Interval 2:      NA
Reading Rate:    Slow (High Res.)
Drift Correction: Yes
Duration:        NA
Temp Units:      Celsius
Monitor Chan:    None
Total Debounce: Yes
Data File:       None
File Mode:       NA
File Format:      NA

Chan  Function  Range  Alarm 1  Alarm 2  Trg  Mx+B  Units  Label
0101  VDC          3V     OFF      OFF      NA   OFF   VDC   Label
0102  VDC          3V     OFF      OFF      NA   OFF   VDC   Label
0103  VDC          3V     OFF      OFF      NA   OFF   VDC   Label
    
```

Figure 3-5. Configuration Text File

Configuring the netdaq.ini File

3-38.

You can modify the netdaq.ini file in the same manner as any text file. Exit and restart NetDAQ Logger to put the changes into effect. Refer to the default netdaq.ini file shown below.

```

[Defaults]
MemoryWrapAround=True
AlarmCheckingIntvl_2640A=1.000
AlarmCheckingIntvl_2645A=0.100
AutoScanDisable=True
CommTimeout=10

[TL Defaults]
TLDir=c:\Program Files\Fluke\tl
TLFile=tl32.exe
TLTitle=Trend Link for Fluke
    
```

The following describes the parameters in the `netdaq.ini` file. If you alter any of the settings, save the old file under a different name in case you want to revert back to the default settings.

- **MemoryWrapAround=True**

This is the instruction for the instrument to follow if its internal scan queue becomes full. When set to true, the instrument overwrites the oldest readings in the buffer. When set to false, the instrument discards the latest readings.
- **AlarmCheckingIntvl_2640A=1.000**

When you select Alarm Trigger for a 2640A instrument, channels eligible for alarm triggering are checked for alarms at this interval. The minimum is 0.5 seconds and the maximum is 86400 seconds (24 hours).
- **AlarmCheckingIntvl_2645A=0.100**

When you select Alarm Trigger for a 2645A instrument, channels eligible for alarm triggering are checked for alarms at this interval. The minimum is 0.05 seconds and the maximum is 86400 seconds (24 hours).
- **AutoScanDisable=True**

When set to true, an instrument automatically disables scanning if its scan queue is full and it has not received any commands from the host for 5 minutes. This feature helps extend the lifetime of relays in the instrument.
- **CommTimeout=10**

This is the duration NetDAQ Logger allows for an instrument to respond to a command. If there is no response from an instrument after nn seconds, NetDAQ Logger displays an error. The minimum is 3 seconds and the maximum is 1000 seconds.
- **TLDDir=c:\Program Files\Fluke\tl**

This is the directory for the Trend Link application. If Trend Link is located somewhere else, you are prompted for the name of the actual directory the next time you perform Trend Link related activities in NetDAQ Logger. You may also modify this setting by selecting Plot/Trend | Trend Link Directory.
- **TLFile=tl32.exe**

This is the file in TLDDir that executes when the you select Plot/Trend | Show Trend Link.
- **TLTitle=Trend Link for Fluke**

This is the title of the Trend window that appears when TLFile executes.

Chapter 4

Operating NetDAQ Logger for Windows

	Contents	Page
4-1.	Introduction	4-3
4-2.	Starting and Stopping Logging.....	4-3
4-3.	Starting or Stopping all Instruments at Once	4-4
4-4.	Starting or Stopping a Group Instrument.....	4-4
4-5.	Clearing an Instrument's Totalizer Value.....	4-5
4-6.	Simulated Logging.....	4-5
4-7.	Selecting an Instrument's Scanning Duration.....	4-5
4-8.	Real-Time Displays	4-6
4-9.	The Logging Status Window	4-7
4-10.	The Readings Table Window.....	4-8
4-11.	The Spy Window	4-9
4-12.	Quick Plot	4-11
4-13.	Dynamic Data Exchange (DDE) Operations	4-12
4-14.	Data Files.....	4-13
4-15.	Configuring a Data File.....	4-14
4-16.	Converting Data Files	4-18
4-17.	Viewing and Printing a Data File.....	4-18
4-18.	Optimizing Performance	4-20
4-19.	Optimizing Performance for Speed.....	4-20
4-20.	Increasing Scanning Rate	4-20
4-21.	Increasing Data Transmission and Storage Rate	4-20
4-22.	Increasing Network Speed.....	4-21
4-23.	Optimizing Performance for Precision.	4-21
4-24.	Using Online Help.....	4-21

Introduction

4-1.

This chapter provides instructions for operating your system using NetDAQ Logger after you have set up communications and configured the instruments. This includes starting and stopping logging, viewing and storing your data, and optimizing system performance.

Starting and Stopping Logging

4-2.

You can start or stop logging for an individual instrument, a group instrument (by starting or stopping the Master), or all instruments.

To start logging for an individual instrument, complete the following procedure:

1. Select the instrument's icon. If the icon indicates "LOG" or "SIM," the instrument is already logging.
2. Select the Logging | Start Instrument or click the Start Instrument button on the toolbar. If the menu command and button are dimmed, the instrument is already logging, or it is a Slave instrument and you must start the Master.

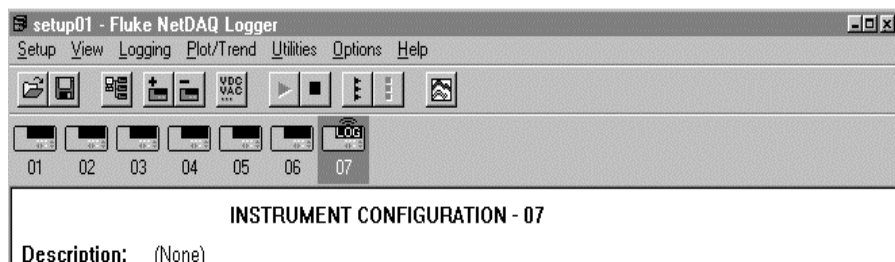

ds053s.bmp

To stop logging for an individual instrument, complete the following procedure:

1. Select the instrument's icon.
2. Select Logging | Stop Instrument or click the Stop Instrument button on the toolbar. If the menu command and button are dimmed, the instrument is not logging, or it is a Slave and you must stop the Master.

Starting or Stopping all Instruments at Once

4-3.

To start logging for all of the instruments in the current setup, select Logging | Start all Instruments or click the Start all Instruments button on the toolbar. If the menu command and toolbar button are dimmed, the instruments are already logging.

To stop logging for all instruments in the current setup, select Logging | Stop All Instruments or click the Stop All Instruments button on the toolbar. If the menu command and toolbar button are dimmed, the instruments are not logging.

Starting or Stopping a Group Instrument

4-4.

To start logging for a group instrument, complete the following procedure:

1. Select the icon for the Master instrument. If the icon says "LOG" or "SIM," the instrument is already logging.
2. Select Logging | Start Instrument or click the Start Instrument button on the toolbar. If the menu command and the toolbar button are dimmed, the instrument is already logging.

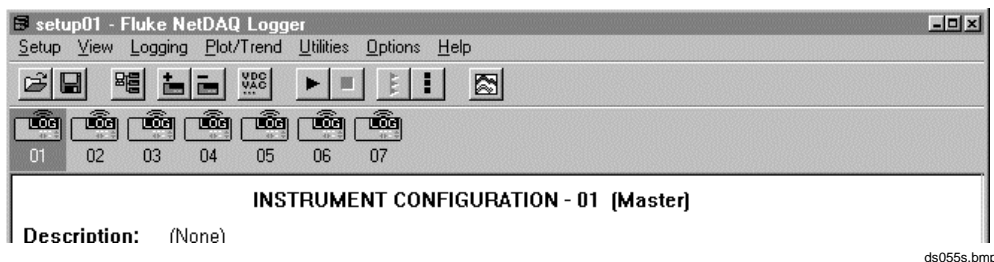

To stop logging for a group instrument, complete the following procedure:

1. Select the icon for the Master instrument.
2. Select Logging | Stop Instrument or click the Stop Instrument button on the toolbar. If the menu command and the toolbar button are dimmed, the instrument is not logging.

Clearing an Instrument's Totalizer Value

4-5.

If you check Logging | Clear Totalizer on Start, NetDAQ Logger will clear the totalizer count in each instrument when you start logging for that instrument. Otherwise, the totalizer value in the instrument will not be cleared.

Simulated Logging

4-6.

If you check Logging | Simulate Logging on Start, NetDAQ Logger will simulate all data collection rather than connecting to the instrument(s). When NetDAQ Logger is simulating data collection for one or more instruments, their icons will read "SIM" instead of "LOG."

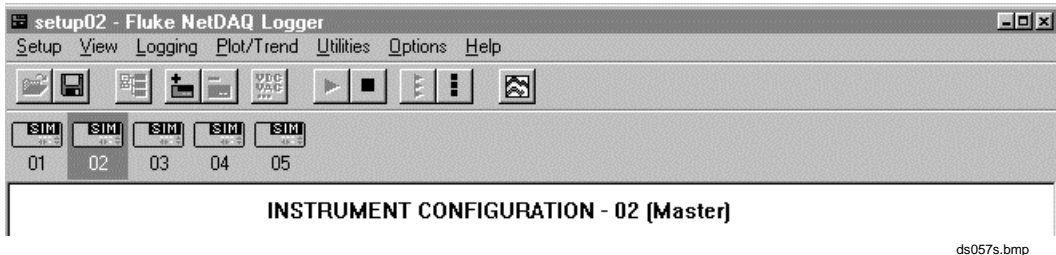

Selecting an Instrument's Scanning Duration

4-7.

Complete the following procedure to select a duration for instrument scanning. NetDAQ Logger will automatically stop logging for the instrument after the specified interval of time has elapsed since the start of logging.

1. Highlight the desired instrument icon.
2. Select Setup | Instrument Config to open the Instrument Configuration dialog box (below).

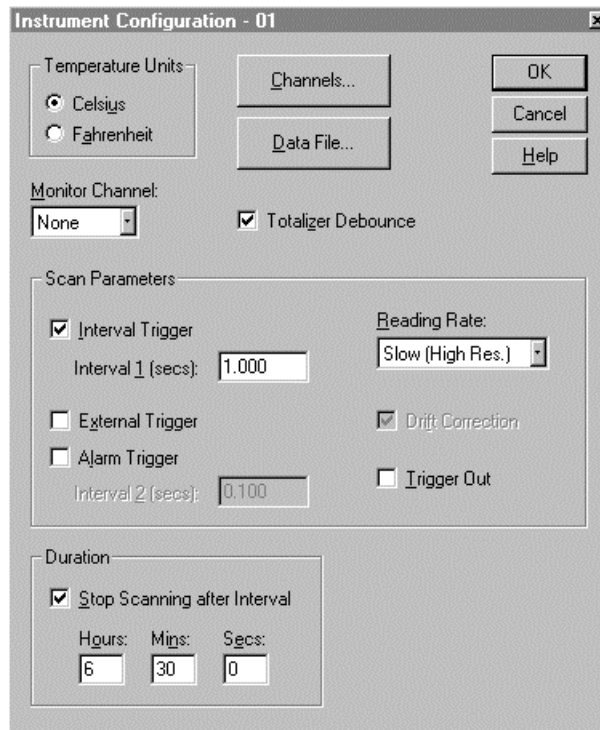

ds029s.bmp

3. Check Stop Scanning after Interval. Enter the hours/minutes/seconds for the duration. The maximum entry is 999 hours, 99 minutes, 99 seconds (999:99:99).
4. Click OK to return to the Main Window.

Real-Time Displays

4-8.

The Real-Time displays let you monitor data as it is being collected. The following displays are available:

- Logging Status displays the status of data collection during real scanning or simulated scanning.
- Readings Table displays the latest scan data collected from the currently selected instrument.
- Spy triggers and collects its own measurements from up to eight channels from any combination of instruments. These measurements are performed in the instrument independent of any scanning.
- Quick Plot provides a quick visual trend of eight channels.

- Trend Link provides a wide range of features for trending real time data or previously collected data. See Chapter 5 of this manual for more information on Trend Link.
- Dynamic Data Exchange (DDE) links measurement data to other applications such as a spreadsheet, with the measurements appearing in other applications as they are being collected.
- The instrument front panel provides a display of channel readings, digital I/O status, or totalizer status. See Chapter 2 of this manual for more information.

The Logging Status Window

4-9.

The Logging Status window, when opened, remains on top of the Main Window. The Options menu in the Main Window provides three selections for the Logging Status window:

- To display the Logging Status window immediately, click Options | Show Logging Status.
- To have the Logging Status window appear when logging starts for one or more instruments, check Show Logging Status on Start.
- To have the Logging Status window appear when a channel goes into alarm during scanning, check Show Logging Status on Alarm. This window will appear on top of all other windows, even if you are in another application.

Note

You must close the Logging Status window before you can access button or menu commands from the keyboard. To close, press the <ESC> key.

The screenshot shows a window titled "Logging Status" with a table of instrument data and an alarm bell icon. The table has four columns: Instrument, Scans In Instrument, Retrieved Scans, and Alarm Occurrences. The data rows are as follows:

Instrument	Scans In Instrument	Retrieved Scans	Alarm Occurrences
01	23	3227	None
05	7	734	12,14,20
22	0	57	None
47	3	15	None
54	1	74	None

An alarm bell icon is located in the top right corner of the window. Arrows point from text labels to specific elements in the window:

- "Instrument listed by BCN" points to the first column of the table.
- "Number of scans in the instrument scan queue" points to the second column of the table.
- "Number of scans retrieved and recorded." points to the third column of the table.
- "Listing of channels where alarms have occurred since the last status update." points to the fourth column of the table.
- "AlarmBell is displayed when at least one channel is in alarm." points to the alarm bell icon.

ds073c.eps

The Readings Table Window

4-10.

The Readings Table provides a numerical display of the most recent data collected from the currently selected instrument. Complete the following procedure to use the Readings Table window:

1. Select Options | Show Current Readings to display the Readings Table window.

Chan	Reading	
0201	0.952941	VDC
0202	0.600000	VDC
0203	-0.364706	VDC
0204	55.6863	°C
0205	98.0392	°C
0206	73.7255	°C
0207	56.0784	°C
0208	59.6078	°C
0209	251.765	Ohms
0210	103.529	Ohms
0211	244.706	Ohms
0212	129.412	Ohms
0213	225.882	Ohms
0214	229.412	Ohms
0215	7.05882	Ohms
0216	0.236471	VAC
0217	-0.0247059	VAC
0218	0.245882	VAC
0219	0.158824	VAC
0220	0.0952941	VAC
0221		
0222		
0223		
0224		
0225		
0226		
0227		
0228		
0229		
0230		
DIO	255	
TOTAL	0	

ds300s.bmp

2. Select the icon of the instrument for which you would like to view incoming data. If this instrument is not currently logging, select Logging | Start Instrument.

The Spy Window

4-11.

The Spy Window displays up-to-date measurements whether or not instruments are scanning. Spy triggers and collects its own measurements from up to eight channels from any combination of instruments. Off-scale readings are displayed as +Overload or -Overload. If Open Thermocouple Detect is enabled, an open thermocouple reading is displayed as “Open TC.”

Complete the following procedure to use the Spy Window.

1. Select Utilities | Spy to open the Spy Channel Selection dialog box. You may select up to 8 channels, including Digital I/O and Totalizer.



ds059s.bmp

2. Click OK to display the Spy window. Double-click in the Spy window to return to the Spy Channel Selection dialog box.

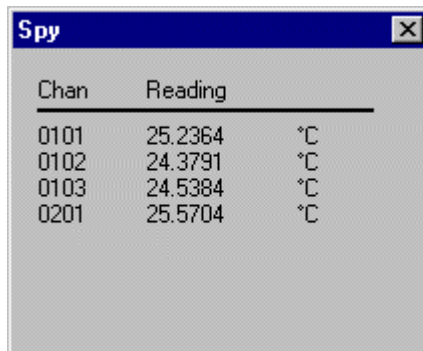

ds060s.eps

Quick Plot

4-12.

Quick Plot provides a quick way to get a simple graphical view of your logging data. Quick Plot samples the incoming scan data at a specified interval and displays a graphical trend of the data. For a more detailed view of your data, use the Trend Link application. Complete the following procedure to set up and display the Quick Plot window. To return to the Quick Plot Setup dialog box at any time, double-click in the Quick Plot window. During simulated logging, Quick Plot shows simulated data.

1. Select Plot/Trend | Quick Plot Setup to open the Quick Plot Setup dialog box is shown.

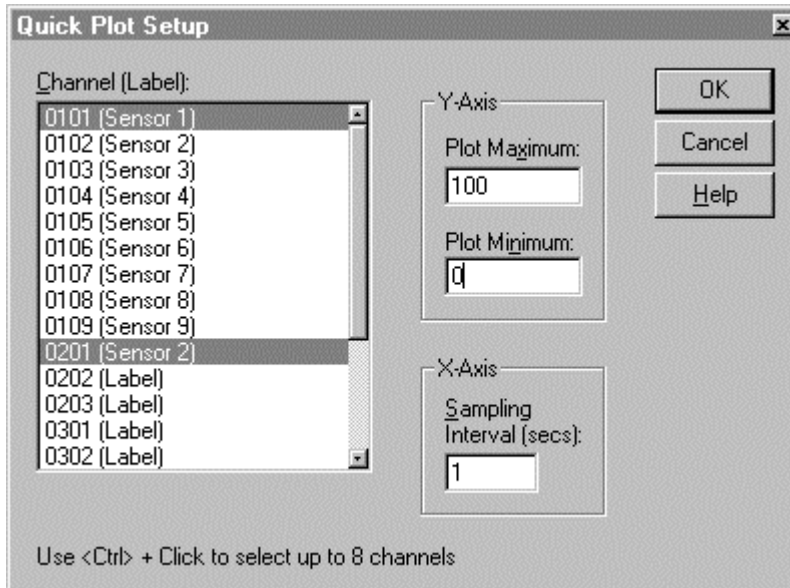

ds043s.bmp

2. Select up to eight channels from the Channel list. Enter the Y-Axis scale and the X-Axis sampling interval. The example above is typical of setting up a Quick Plot. Click OK.

A summary of Quick Plot attributes is shown below.

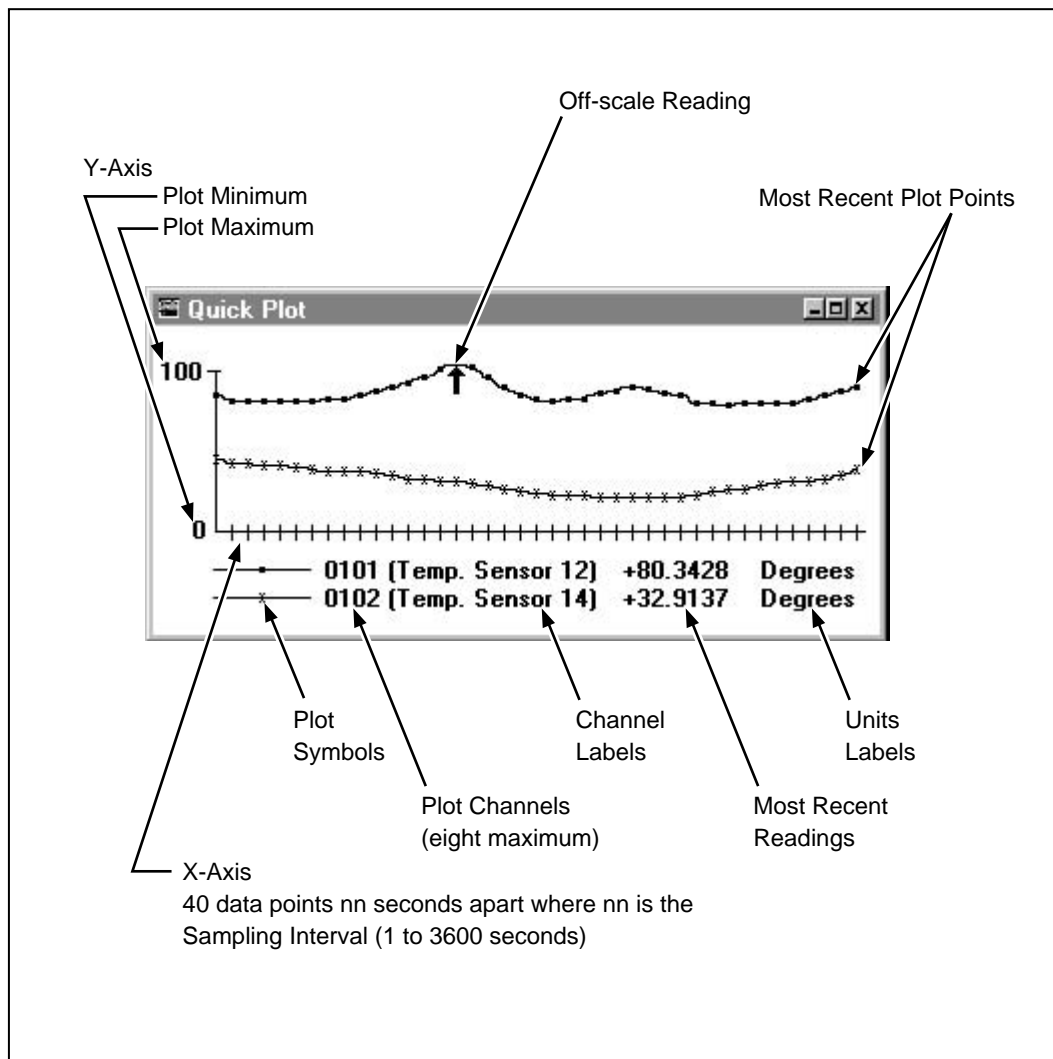

ds074c.eps

Dynamic Data Exchange (DDE) Operations

4-13.

Complete the following procedure to set up typical Dynamic Data Exchange operations. See Appendix G “Dynamic Data Exchange (DDE)” for a DDE example using Excel.

In the client application (for example, a spreadsheet application), enter the following values to set up a DDE link:

Application or Service Name: NETDAQ (16-bit) or NETDAQ32 (32-bit)

Topic: BCNnn (nn is the instrument BCN 01 to 99)

- Items:** 'Cnn' (nn is the channel number 01 to 30)
- DIO (Digital I/O status, decimal equivalent of the 8 I/O lines)
 - Totalizer (Totalizer count, 0 to 4294967295)
 - Alarm1 (Alarm 1 status, decimal equivalent of the 30 Alarm 1 states)
 - Alarm2 (Alarm 2 status, decimal equivalent of the 30 Alarm 2 states)
 - ELDateTime (Scan date/time in Excel/Lotus 1, 2, 3 format)

Begin data collection, observing the data display in the client application. The timestamps are directly compatible with Excel and Lotus 1,2,3 analysis applications.

Data Files

4-14.

Data files contain the measurement data collected from the instruments. After the instrument completes a measurement scan, the data is stored temporarily in the instrument's internal memory. NetDAQ Logger retrieves the scan data over the network and records it into a data file. Data files are recorded in one of three formats: Fast Binary, ASCII, or Trend Link.

A summary of each data file type is as follows.

- Fast Binary

The Fast Binary data file format provides the fastest way of getting data to disk and uses the least amount of disk space. Fast Binary is the only data file format that you can convert directly to the other two data file formats: ASCII (CSV) and Trend Link. The NetDAQ Logger Utilities menu lists the conversion utilities for Fast Binary files.

- ASCII

The ASCII (CSV) data file format stores the data in ASCII characters and is directly compatible with analysis applications like Excel and Lotus 1,2,3. If you use a spreadsheet for data analysis, then the ASCII (CSV) data file format may be the best choice.

You can convert an ASCII file to text. The text data file format is the same as the ASCII format, except that the timestamps have been converted into date/time strings using the Converting Data File ASCII Timestamps procedure (Utilities menu). The default file extension for text data files is *.txt.

- Trend Link

The Trend Link data file format requires using the real-time trending capability offered by the Trend Link trending package. You can record data into Fast Binary and then convert it into the Trend Link format.

When using the Trend Link format, you may specify a deadband value for each channel. This value determines the amount of change that a channel reading value must undergo before an updated value is logged into the file. The deadband value helps to limit the quantity of data recorded to the data file.

The Trend Link format also allows you to place data into batches. The Trend Link application can display data from multiple batches, allowing direct comparison between current and historical data.

The auto rollover feature provides a means of logging data into a series of files rather than a single file, for easier data management. NetDAQ Logger will automatically “rollover” a data file when a specified condition is met, such as file size. When a rollover occurs, the current data is renamed and a new file is created with the original filename. ASCII (CSV) and binary files are sequenced as filename.001, filename.002, etc. In the Trend Link format, data is recorded into the *.now file and rolled into *.tlg files.

Configuring a Data File

4-15.

Complete the following procedure to configure a data file for recording instrument measurement data. Each Asynchronous Instrument or Group Instrument has its own data file.

1. Highlight the instrument icon on the Icon Bar (for a Group Instrument, select the Master). Open the Instrument Configuration dialog box.
2. Click Data File to open the Data File Configuration dialog box.

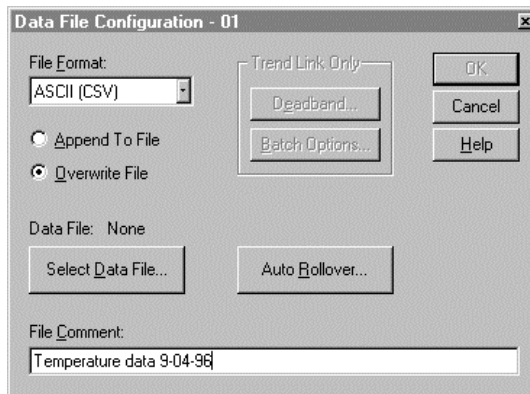

ds062s.bmp

3. Select the desired File Format. For the Fast Binary or ASCII (CSV) format, select Append to File or Overwrite File. This file mode determines what happens when logging starts if a data file of the same name exists. Enter text characters (79 maximum) into the File Comment box. (The File Comment text appears in the header of the data file.)
4. Click Select Data File. Enter the file name. The default extensions are *.csv (ASCII), *.bin (Fast Binary), and *.set (Trend Link). Click Save to save the name entry of that file. The name of your data file now appears in the Data File Configuration dialog box.

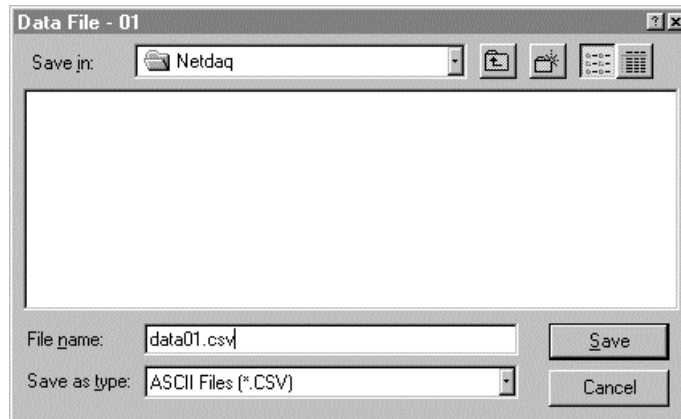

ds037s.bmp

5. Click Auto Rollover to open the Auto Rollover dialog box.

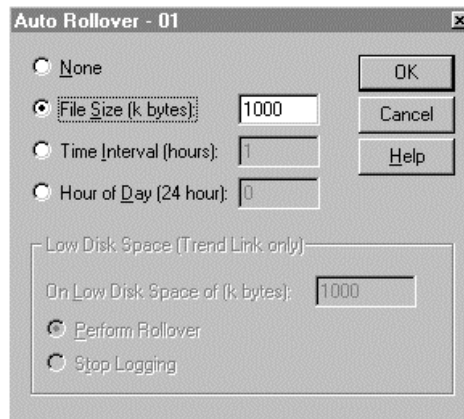

ds065s.bmp

6. Select the desired Auto Rollover type and its associated value. The data file may be automatically rolled over when it reaches a specified size, when a time interval elapses from the last rollover, or at a particular time each day.

To safeguard your data when recording in the Trend Link format, you must perform a rollover or stop logging data before your disk completely fills up. The default low disk space value of 1000K will typically be enough to safeguard your data. Use a larger value when rapidly logging large quantities of data from several instruments in the Trend Link format.

7. Click OK to return to the Data File Configuration dialog box.
8. For a Trend Link File, click Deadband from the Data File Configuration dialog box to open the Deadband Values dialog box.

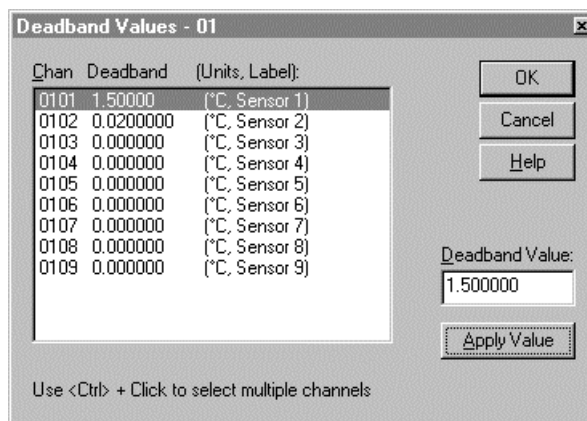

ds063s.bmp

9. Select the desired channels, enter the Deadband Value, and click Apply Value. A deadband value of zero will result in all data being recorded to the data file.
10. Review the values and click OK to return to the Data Configuration dialog box.
11. Click Batch Options in the Data File Configuration dialog box to open the Batch Options dialog box.



ds301.bmp

12. Enter a batch name and the desired batch definition and click OK to return to the Data File Configuration dialog box.

Use the batch definition to tell NetDAQ Logger when to mark the start and stop points of batches:

- Entire logging session.
- Period while DIO line is low. You can use a DIO input to start and stop batches. The batch starts when the DIO line goes low (or on start logging if the DIO line is already low), and stops when the DIO line goes high (or on Stop Logging if the DIO line remains low).
- Periodic interval. You can indicate an interval for the start of new batches. NetDAQ Logger will start a batch on Start Logging and, every time the interval expires, it will stop the current batch and start a new one. You can specify a time of day for the first batch to start as an alternative to starting on Start Logging.

13. Review the Data File Configuration dialog box and click OK if satisfactory to return to the Instrument Configuration dialog box. Click OK to return to the Main Window.

Converting Data Files

4-16.

You can convert data files to other types for compatibility with your data management applications. NetDAQ Logger performs the following conversions:

- Binary to ASCII
- ASCII to Text (timestamp conversion)
- Binary to Trend Link

Complete the following procedure to perform one of these conversions. This conversion does not modify or destroy the original file, but creates an additional file in the new format.

1. From the Utilities menu select a conversion type to open the conversion dialog box. The example below shows the Binary to Trend Link dialog box.
2. Click Select Binary File, and select the desired binary file from the File Name list or enter the file name in the File Name box. Modify the directory path as required and click Open.
3. Click Select Text File and enter the file name in the File Name box. Modify the directory path as required and click Save.
4. Verify you have the desired file names. Click Convert to convert the file.

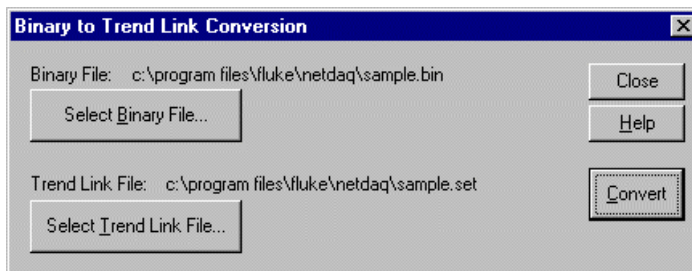

ds046s.bmp

5. Click Close to return to the Main Window.

Viewing and Printing a Data File

4-17.

Complete the following procedure to view and print a data file, which is assumed to be in text format. (See “Converting Data Files.”)

1. Minimize NetDAQ Logger and open the Notepad application.
2. Select File | Open and enter the file name and directory path.

The example below is a typical data file in text format. Off-scale measurements are recorded as +1.0E+9 (+overload) and -1.0E+9 (-overload). Open thermocouple measurements are recorded as +9.0E+9.

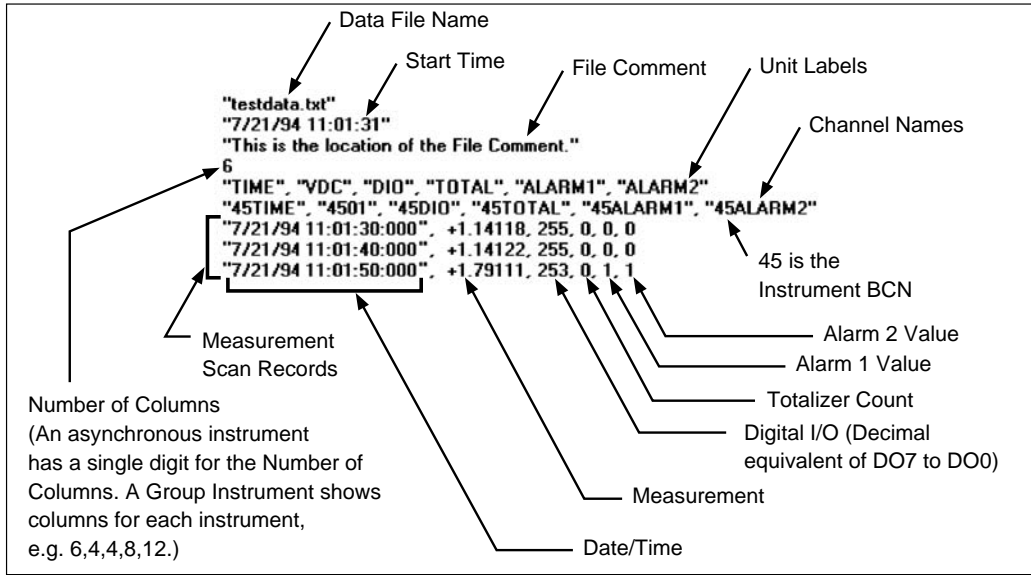

ds071c.eps

3. The Alarm 1 and Alarm 2 values provide a record of which channels were in alarm during the scan. These values are formatted as follows.

29	28	27	26	25	24	23	22	21	20	19	18	17	16	15	14	13	12	11	10	9	8	7	6	5	4	3	2	1	0	BITS	
30	29	28	27	26	25	24	23	22	21	20	19	18	17	16	15	14	13	12	11	10	9	8	7	6	5	4	3	2	1	CHANNEL	
EXAMPLES																															
0	0	0	0	0	0	0	0	0	0	0	0	0	0	0	0	0	0	0	0	0	0	0	0	0	0	0	0	0	0	0	
0	0	0	0	0	0	0	0	0	0	0	0	0	0	0	0	0	0	0	0	0	0	0	0	0	0	0	0	0	0	1	
1	1	1	1	1	1	1	1	1	1	1	1	1	1	1	1	1	1	1	1	1	1	1	1	1	1	1	1	1	1	1073741823	
0	0	0	0	0	0	0	0	0	0	0	0	0	0	0	0	0	0	0	0	0	0	0	0	1	0	1	1	1	0	46	
0	0	0	0	0	0	0	0	0	0	0	0	0	0	0	0	0	0	0	1	1	1	0	0	0	0	0	0	1	1	1795	
0	0	0	0	1	1	0	0	0	1	0	0	0	0	1	1	1	0	0	0	0	0	1	0	0	0	0	1	1	0	51409030	

Alarm value 0 indicates no channels were in alarm for this scan.
 Alarm value 1 indicates channel 1 was in alarm for this scan.
 Alarm value 1073741823 indicates all channels were in alarm for this scan.
 Alarm value 46 indicates channels 6, 4, 3, and 2 were in alarm for this scan.
 Alarm value 1795 indicates channels 11, 10, 9, 2 and 1 were in alarm for this scan.
 Alarm value 51409030 indicates channels 26, 25, 21, 16, 15, 14, 8, 3, and 2 were in alarm for this scan.

ds072c.bmp

Optimizing Performance

4-18.

You can set up instrument operations to optimize either your system's data collection rate or measurement precision, depending on your requirements. The procedures in this section describe the options for optimizing performance.

Optimizing Performance for Speed

4-19.

To optimize the data collection rate of your system, you can alter the parameters that affect the instrument's scanning rate, the data put through from the instrument to the data file, or the speed of the network.

Increasing Scanning Rate

4-20.

Follow these guidelines to increase the rate at which an instrument collects data.

- Select the Fast Reading Rate.
- Use similar functions on contiguous channels. For example, if measuring dc volts on four channels and thermocouple on four channels, configure channels 1, 2, 3, and 4 for dc volts, and channels 5, 6, 7, and 8 for thermocouples. (See "Configuring Analog Channel Functions.")
- Turn the Drift Correction feature off.
- Turn the Open Thermocouple Detect feature off.
- Do not use the Trigger Output function.
- Do not monitor channel readings, DIO or totalizer status at the instrument front panel.

The following measurement features can also slow down scanning.

- Slow measurement functions such as frequency and ac volts.
- Using Autorange for range selection.
- The use of computed channels.
- Mx+B scaling.
- Channel alarms.

Increasing Data Transmission and Storage Rate

4-21.

Follow these guidelines to increase the rate of data throughput from the instrument to the data file.

- Select Fast Binary as the data file format.
- Do not have more instruments logging than are necessary.

In addition, try to avoid running other tasks on the computer when you are writing to the data file. The following suggestions are:

- Avoid using the Quick Plot, Spy, Readings Table, or Logging Status windows.
- Avoid using the Trend Link window in real time.
- Close any other applications that are open.
- Avoid the use of screen savers.
- Avoid file conversion operations during scanning. (See “Data Files.”)
- Increase the amount of RAM in your computer if possible.

Increasing Network Speed

4-22.

Use these guidelines to increase network speed.

- Place instruments on an isolated network to avoid high network traffic and network down time. If you are using a general network, place the instruments and host computers on the same subnet.
- Install the Ethernet Card in a 16-bit slot.

Optimizing Performance for Precision

4-23.

More precision can mean sacrificing some of the instrument’s measurement speed. The guidelines for increasing the data throughput and the network speed do not affect the precision of your instruments and you can use them during high precision measurements.

To optimize precision for all measurement methods and functions:

- Select the Slow Reading Rate.
- Enable the Drift Correction feature.

Using Online Help

4-24.

NetDAQ Logger includes extensive Online Help. Here are some ways you can use online assistance more effectively:

- Press the F1 key at any time to open the Online Help for information on the screen you are currently using.
- When conducting procedures described in Online Help, reduce the size of the Help window, and check Always on Top to use help while you operate NetDAQ Logger.
- The front panel graphic (shown below) precedes Help topics concerning use of the instrument’s front panel.



Chapter 5

Using Trend Link for Fluke

	Contents	Page
5-1.	Introduction	5-3
5-2.	Displaying a Trend Link Chart During Logging.....	5-3
5-3.	Playing Back a Trend Link File in Trend Link.....	5-4
5-4.	Playing Back a Fast Binary File in Trend Link.....	5-5
5-5.	Playing Back an ASCII (CSV) File in Trend Link	5-6
5-6.	Importing Trend Link Data Files	5-6
5-7.	Create a New Trend Link Data Set Directory	5-6
5-8.	Add the New Folder to the Trend Link infolink.ini File....	5-6
5-9.	Import the NetDAQ ASCII (CSV) File into Trend Link.....	5-7
5-10.	Display the Trend Link Chart for the Imported File.....	5-7
5-11.	Title the Trend Link Chart.....	5-8
5-12.	Save the Trend Link Chart.....	5-9
5-13.	Exporting Trend Link Data Files	5-9
5-14.	Deleting Old Trend Link Files	5-11
5-15.	Getting the Right Look for Your Trend Link Chart	5-12
5-16.	Using the Trend Link Control Bar	5-12
5-17.	Using the Trend Link Menus	5-15
5-18.	Adjusting the Curve Time Scale (X-axis)	5-15
5-19.	Adjusting the Curve Amplitude Scale (Y-axis).....	5-16
5-20.	Configuring the Curve Status Display	5-17
5-21.	Curve Preferences.....	5-18
5-22.	Background Preferences	5-21
5-23.	Real Time Frequency Update	5-23
5-24.	Adding or Changing the Chart Title	5-23
5-25.	Using the Note System	5-24
5-26.	Printing a Chart.....	5-24

Introduction

5-1.

Trend Link for Fluke (Trend Link) graphs real time and historical data in the Microsoft Windows environment. This chapter supports Trend Link operation with a series of procedures to use in conjunction with NetDAQ Logger. Refer to the *Trend Link for Fluke Reference Manual* for complete information. Make sure that you have installed Trend Link as described in Chapter 2, "Installing Trend Link."

Displaying a Trend Link Chart During Logging

5-2.

Complete the following procedure to display a Trend Link chart in real time during logging. This procedure assumes you have configured the network and instruments for operation and have selected Trend Link as the data file format. (See "Data Files" in Chapter 4.)

1. In NetDAQ Logger, select the desired instrument on the Icon Bar. Verify that Trend Link shows in the File Format field in the Main Window as shown below.

If the file format is ASCII or Binary, you will not be able to display a Trend Link chart in real time.

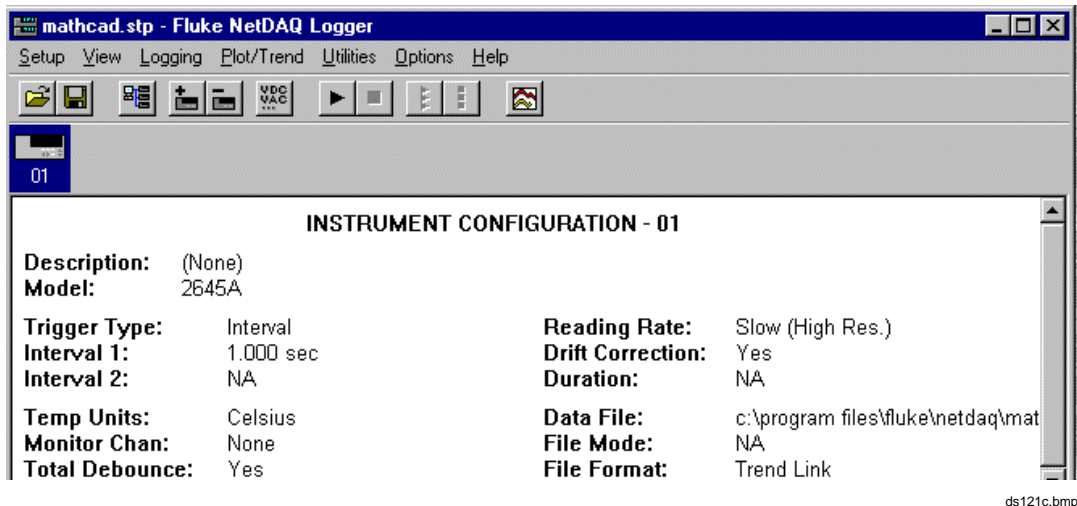

2. Select Logging | Start Instrument (or click the Start Instrument button on the toolbar) to begin logging data from the instrument to the Trend Link data file.
3. To display the Trend Link chart, select Plot/Trend | Show Trend Link.

Note

If this is the first use of the Trend Link data file, allow a few seconds for Trend Link to create the folder and files used for the chart.

4. To change the look of the chart, see "Getting the Right Look for your Trend Link Chart" later in this chapter.
5. Click the Stop Instrument button on the toolbar when you wish to terminate scanning operations.
6. To save changes to the chart, select File | Save in Trend Link. By saving the chart, you can play it back at a later time with the same settings.
7. Close Trend Link by selecting File | Exit.

Playing Back a Trend Link File in Trend Link**5-3.**

Complete the following procedure to play back a NetDAQ Trend Link data file using Trend Link.

1. Open Trend Link from Start | Programs or select Plot/Trend | Show Trend Link in NetDAQ Logger. The figure below shows a typical Trend Link opening screen.

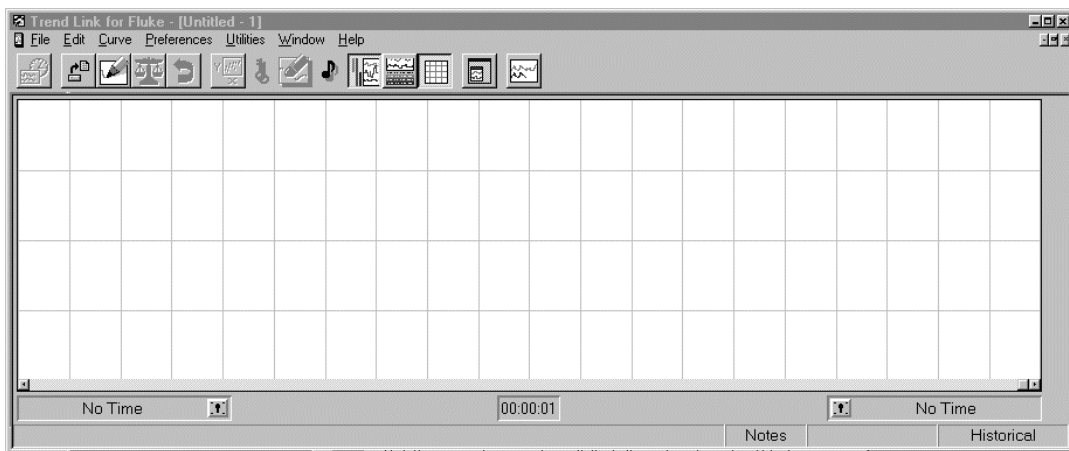

ds122s.bmp

2. Select File | Open to display the Chart Open dialog box.

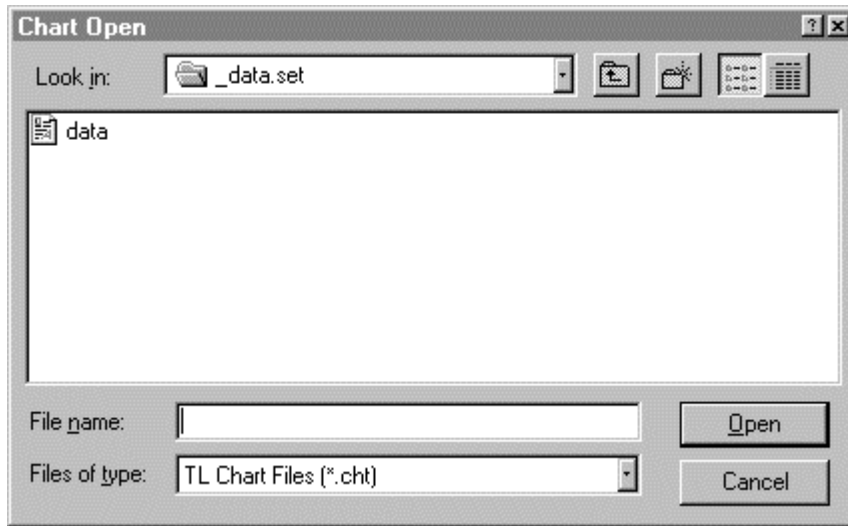

ds123s.bmp

3. Select the chart file to play back. For example, select `c:\Program Files\Fluke\netdaq_data.set\data.cht`
4. Click OK.
5. Observe that the selected chart opens. Use the scroll bar at the bottom of the chart to display the measurement area of interest.
6. Select `Edit | Add Curve` to view data from additional channels in the Trend Link file.
7. After viewing the chart or performing other chart operations, select `File | Exit` to exit Trend Link, saving the changes as required.

Playing Back a Fast Binary File in Trend Link

5-4.

Complete the following procedure to play back a NetDAQ Fast Binary file in Trend Link.

1. In NetDAQ Logger, convert the Binary formatted file to a Trend Link formatted file by selecting `Utilities | Binary to Trend Link Conversion`. (See "Converting Data Files" in Chapter 4.)
2. Complete the "Playing Back a Trend Link File in Trend Link" procedure (above).

Playing Back an ASCII (CSV) File in Trend Link 5-5.

To play back a NetDAQ Logger ASCII (CSV) data file in Trend Link, refer to “Importing Trend Link Data Files” in this chapter. Specify Fluke Format (*.csv) for the Import File Type. Be sure you do NOT import the same ASCII (CSV) file more than once into the same Data Set as this causes a timestamp conflict.

For future NetDAQ Logger data logging, you may prefer to use Fast Binary instead of ASCII data file format. Fast Binary converts easily to Trend Link format when you select Utilities | Binary to Trend Link Conversion. Fast Binary also converts easily to ASCII (CSV) format when you select Utilities | Binary to ASCII Conversion.

Importing Trend Link Data Files 5-6.

You can import standard *.csv, Iconics Format (*.prn), and Fluke Format *.csv data files using the Trend Link Import *.CSV File utility. For example purposes, the procedure below shows how to import a Fluke Format ASCII (CSV) data file. You can adapt this procedure to standard *.csv and Iconics Format *.prn as required.

Create a New Trend Link Data Set Directory 5-7.

1. In the Windows Explorer utility, create a new folder for a Trend Link Data Set in `c:\Program Files\Fluke\netdaq` by highlighting the `c:\Program Files\Fluke\netdaq` folder and then selecting File | New | Folder. Use the NetDAQ convention for Trend Link Data Set folders by starting with an underscore, followed by up to seven characters with the extension *.set. Click OK.

Hint: Use the Configurator program supplied with Trend Link to create a new Data Set. See Configurator program information in the *Trend Link for Fluke Reference Manual*.

2. Observe that Windows Explorer shows the new folder under `c:\Program Files\Fluke\netdaq`.

Add the New Folder to the Trend Link *infolink.ini* File 5-8.

While still in Windows Explorer, select the file `c:\Program Files\Fluke\tl\infolink.ini`, which opens the file in the Windows Notepad accessory. Locate the portion of the file with the heading: [TL Data Set Paths]. Add a line under this heading with the name and path for the new Data Set. The format is: Data Set name = Data Set path. For example, adding the Data Set name `data.set` to the Data Set path `c:\Program Files\Fluke\netdaq_data.set` results in the entry shown below.

```
[TL Data Set Paths]
```

```
data.set=c:\Program Files\Fluke\netdaq\_data.set
```

Save the changes and exit Notepad.

Import the NetDAQ ASCII (CSV) File into Trend Link

5-9.

Open Trend Link from the Programs list. Select Utilities | Import CSV Data to display the Import *.CSV File dialog box. Make the following selections:

Target Data Set Double-click the Data Set you entered earlier in the Data Sets box to enter the name in the Target Data Set box. For example, double-click `data.set`.

Import File Type Select **Fluke Format (*.csv)**

Filename Enter the complete path to the NetDAQ ASCII (CSV) file you want to play back in Trend Link. For example, enter `c:\Program Files\Fluke\netdaq\testdata.csv`.

Field Delimiter Verify Custom and comma (,) selections.

Click OK when you have made all selections.

Allow several seconds for importing the NetDAQ ASCII (CSV) file into the Trend Link Data Set directory you created.

Display the Trend Link Chart for the Imported File

5-10.

Select Edit | Add Curve to open the Add Curve dialog box. Double-click the name of your Data Set in the Data Set box. Click the desired Tag name (curve) from the Tags box and then click OK to display the curve. The following example displays Tag 0101 from the Data Set `data.set`. Repeat this step for each curve that you want to examine in Trend Link.

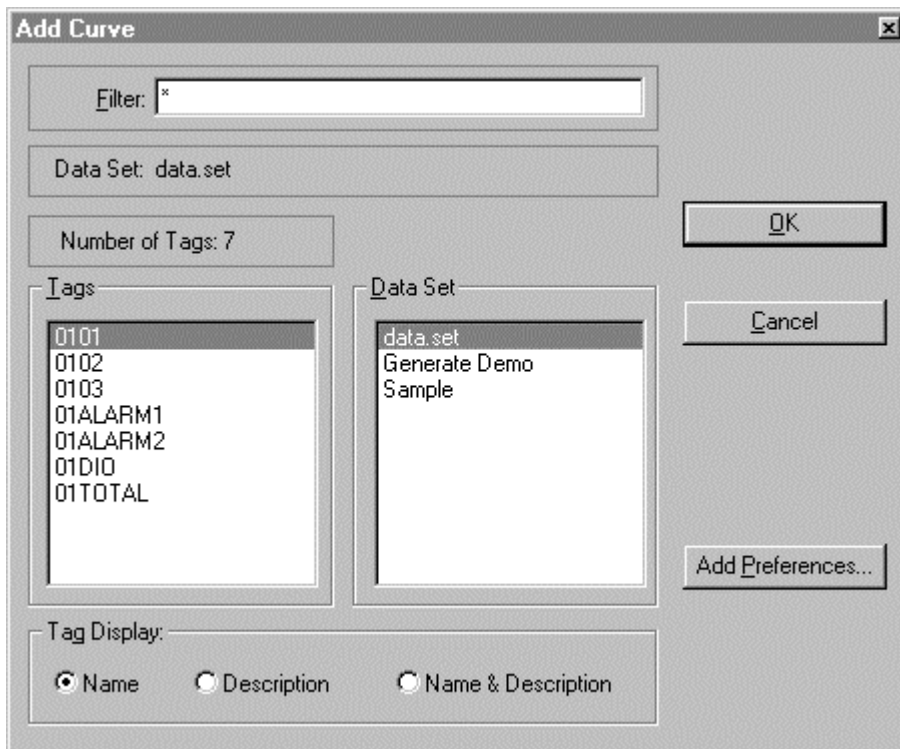

ds126s.bmp

Examine the chart and perform any standard Trend Link procedures to view, print, and so forth. (See "Getting the Right Look for Your Trend Link Chart.")

Title the Trend Link Chart

5-11.

To open the Chart Title dialog box, select Preferences | Chart Title. Enter the desired title and click OK.

Observe that the entered text appears at the top of the chart in the Title Bar.

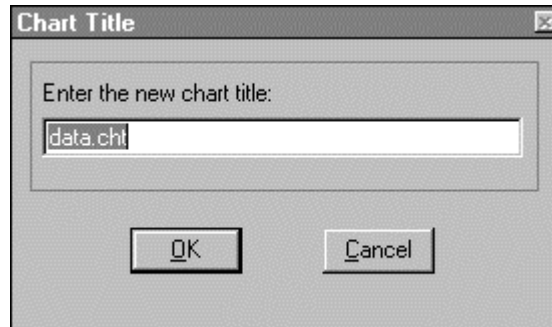

ds139s.bmp

Save the Trend Link Chart

5-12.

To save the Trend Link chart, select File | Save As. Enter the path to your Data Set directory for the *.cht chart. For example, enter c:\Program Files\Fluke\netdaq_data.set\data.cht. Click OK.

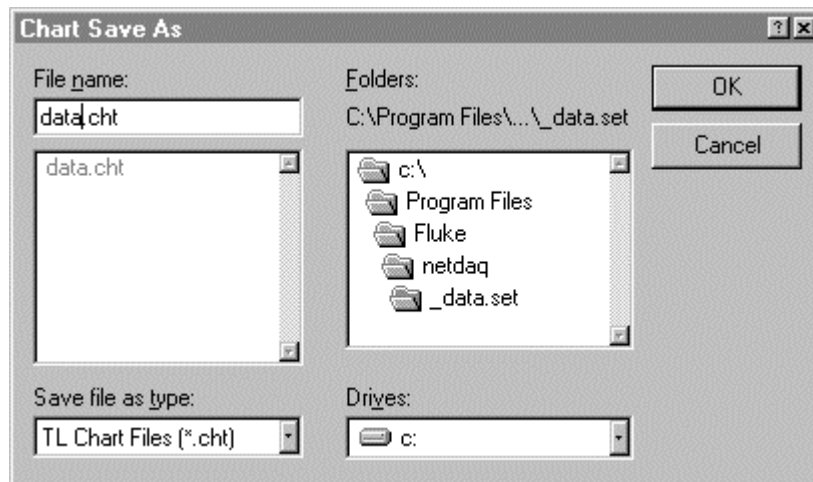

ds150s.bmp

Exporting Trend Link Data Files

5-13.

Trend Link can export data files into one of three Export File Type formats: Standard Comma Separated Values (*.csv), MathCad Array Format (*.prn) and Spread Sheet Column Oriented (*.csv). Note that the Trend Link *.csv formats are *not* compatible with the NetDAQ Logger ASCII (CSV) data file format.

Complete the following procedure to export a data file from Trend Link. This procedure assumes the NetDAQ Logger data file for export is already in Trend

Link format. If this is not the case, see "Playing Back a Fast Binary (BIN) File in Trend Link" or "Playing Back an ASCII (CSV) File in Trend Link" for conversion procedures.

1. Open Trend Link from Start | Programs.
2. Select File | Open and select the desired Trend Link chart. Click OK.
3. Adjust the Trend Link chart to display the desired data you wish to export. **Trend Link only exports the data displayed on the chart!** The example below shows 6 minutes of the chart data .cht being exported. (See "Getting The Right Look For Your Trend Link Chart" to adjust the display to show the desired data.)

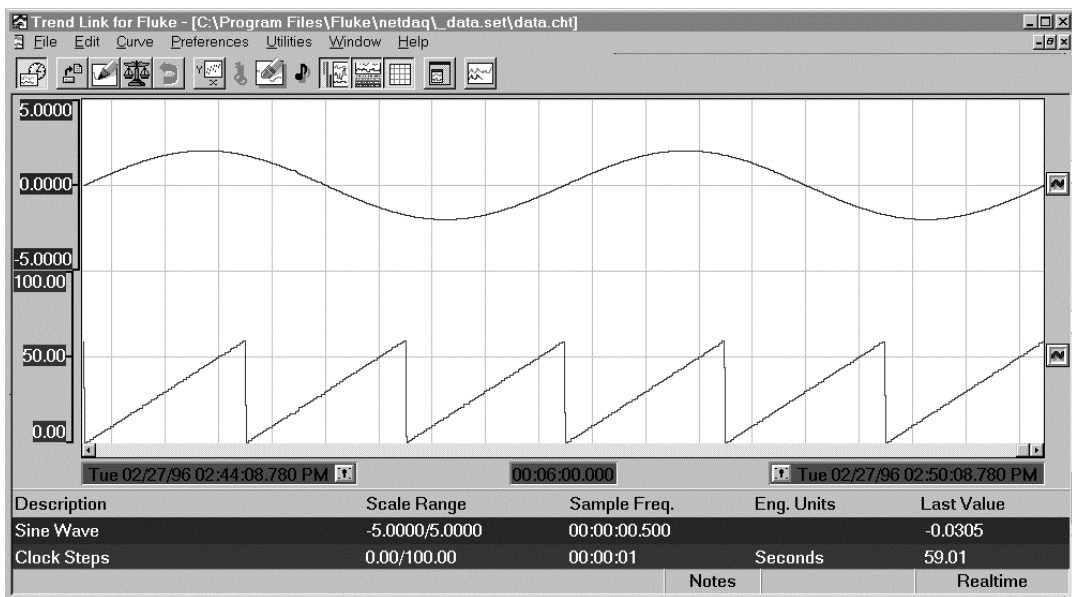

ds128s.bmp

4. Select Utilities | Export CSV Data to open the Export Data dialog box. Select the Export File Type, Sample Rate time resolution of the exported data file in the format Hours:Minutes:Seconds, and the name of the exported file. The example below shows the data.set file exported in Column Heading Format as file:

```
c:\Program Files\Fluke\netdaq\_data.set\data.csv
```

with a sampling interval of 0.5 second. Click OK.

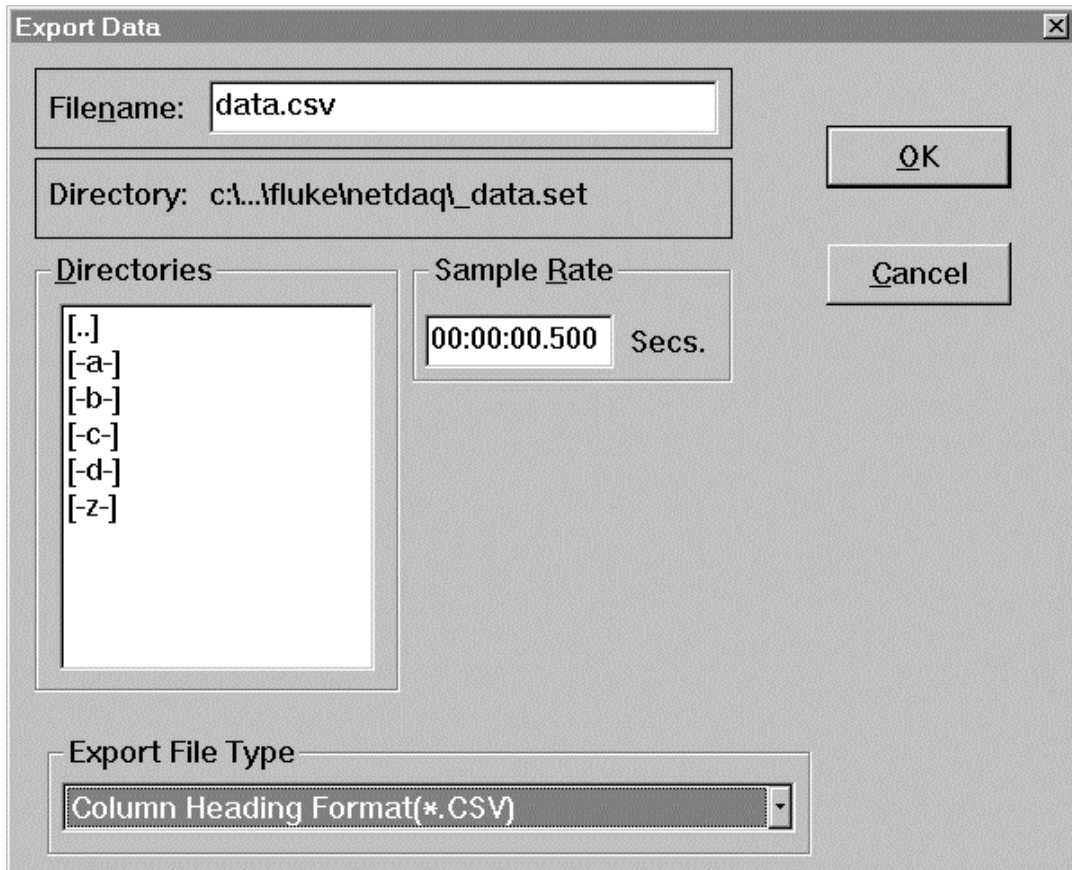

ds151s.bmp

Deleting Old Trend Link Files

5-14.

NetDAQ Logger creates a *.set file and a directory for every new Trend Link data file. The directory name is identical to the Trend Link data file name, except for an underscore "_" character prefix. The actual data resides in this directory.

To delete a Trend Link data file, use Windows Explorer or File Manager to delete the directory and its contents. Also, delete the *.set file. Then, open the Configurator application and complete the following steps:

1. Double-click the `c:\Program Files\Fluke\tl\infolink.ini` file to display the contents using the Notepad accessory. Delete the line under the heading [TL Data Set Paths] that relates to the directory you deleted above.
2. Save the changes to `infolink.ini` and exit Notepad.

3. Repeat Steps 2 and 3 for each Trend Link Data Set being deleted.

Getting the Right Look for Your Trend Link Chart **5-15.**

When you display a Trend Link chart, you can modify the chart appearance to suit your application. Use the Control Bar or various menu selections, as described below.

Using the Trend Link Control Bar **5-16.**







The Control Bar in the Trend Link window (below) allows you to quickly modify the chart display.









ds131s.bmp

See the *Trend Link for Fluke Reference Manual* for more information on menu items and other Trend Link capabilities.

Control Bar

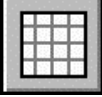
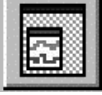
	<p>Historical Mode: Click to freeze the chart during the Real Time Mode, allowing you to use the scroll bar at the bottom of the chart to back up to any portion on the recorded chart. If you are collecting measurement data using the Real Time Mode, you do not lose data while you are in the Historical Mode. Real Time Mode: Click again to view measurement data collection in real time.</p>
	<p>Open an Existing Chart Click the Open Chart button to display the Chart Open dialog box. Double-click on the desired existing file to open an existing chart. A prompt asking to save the current chart appears.</p>
	<p>Adding a Curve Click to open the Add Curve dialog box. Double-click the desired * .set line in the Data Set box to display the available Tags. Double-click the desired tag in the Tags box to add the curve.</p>
	<p>Setting Autoscaling To clear a Fixed Range and return to autoscaling, click the Autoscale button. Notice that the fixed range you entered in Setting a Fixed Range clears.</p>
	<p>Undo and Redo Click the Undo/Redo button to undo any time scale change.</p>
	<p>XY Curve Plot This feature gives you a chart which plots one curve against another. Click the XY Curve Plot button, which displays an X symbol. Position the X symbol over a Curve icon and click. The X symbol changes to a Y symbol. Position the Y symbol over another Curve icon and click again. This displays the XY Curve Plot window, which displays a plot of the Y curve against the X curve. Click OK to return to the chart.</p>
	<p>Locking a Time You can press the left mouse button while over the key and hold it down, you can drag the key in the Control Bar over one of the locks in the two time displays. By releasing the button while over one of the locks, you place the key in that lock. A shortcut to accomplish the same task is by double-clicking the mouse while over one of the locks. This causes the key to automatically go into the lock. To unlock a time, simply click over the lock and drag the key off the lock and release it.</p>

	<p>Erasing a Curve To erase a curve, click this button, hold the mouse button down, drag the Eraser icon on top of the Curve icon, and release the mouse button.</p>
	<p>Adding Notes To enable the Note icon on the Control Bar, select Preferences Note System. Click the Historical Mode button to freeze the chart. Drag the Note icon to any point on the curve (it must touch part of the curve) and release. In the Note dialog box, add your text, then click OK. Click Yes in the Add Note message box. Double-click the Note icon on the curve to review your text. Click OK.</p>
	<p>Curve Band Bars When this button is down, Trend Link displays the band bars for all curves on the chart. When the button is up, the band bars are off. The band bars appear to the left of the curve window as thin colored bars. They may optionally be displayed with scale values.</p>
	<p>Curve Status Window Click on and off to toggle display of the Curve Status Window at the bottom of the chart. The Curve Status Window, which is color-coded to the curve traces and the Curve Symbol icons, displays information about each curve.</p>
	<p>Grid Lines On/Off Click to turn the chart background grid lines on and off.</p>
	<p>Stay on Top Mode Click to display the Trend Link window on top of all other windows.</p>
	<p>Batch Mode Click in to enter Batch Mode. Click out to enter Continuous Mode.</p>
	<p>Measurement Cursor Click and hold the left mouse button anywhere in the chart display area to display the measurement cursor. You can then select any data point on the chart for time and measurement value display.</p>

Using the Trend Link Menus

5-17.

The Trend Link menus (below) allow you to modify the chart display appearance and functionality. This section does not discuss menu functions repeated on the Control Bar. (See "Using the Trend Link Control Bar.") This section only summarizes the menu functions. Refer to the *Trend Link for Fluke Reference Manual* for complete menu information.



File Edit Curve Preferences Utilities Window Help

ds245s.bmp

This section contains the following common menu procedures:

- Adjusting the Curve Time Scale (X-axis)
- Adjusting the Curve Amplitude Scale (Y-axis)
- Configuring the Curve Status Display
- Curve Preferences
- Background Preferences
- Real Time Frequency Update
- Adding or Changing the Chart Title
- Using the Note System
- Printing a Chart

Adjusting the Curve Time Scale (X-axis)

5-18.

Complete the following procedure to adjust the curve time scale (X-axis).

1. Double-click the Time Interval Window at the bottom of the chart (see below) to open the Change Time dialog box.

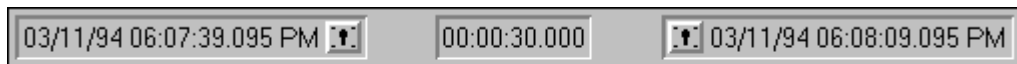

Time Interval Window →

ds242c.bmp

2. In the Change Time dialog box, enter the time for the curve display, that is, the time from the left edge to the right edge of the curve. The format is 00:00:00.000 (hours:minutes:seconds.fraction). For example, 00:00:30.000 represents 30 seconds. Click OK. You can only enter a time that is equal to or less than the overall recorded chart time. For example, if you have been collecting data for 6 hours, you can enter a number up to 6 hours. (For this operation, be sure to position the bottom scroll bar to the far-right.)

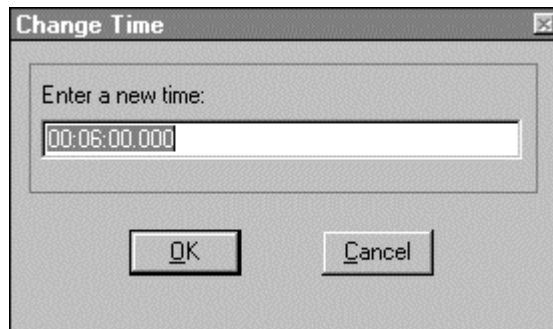

ds132s.bmp

To change the default value so that *all* created charts will have a selected preset value in the Time Interval Window, use the Notepad accessory to modify `c:\Program Files\Fluke\netdaq\tldef.cht`. Find [Section: Curve Window], and add the line `Curve Window Interval Time=nnnnnnn`, where `nnnnnnn` is the time in milliseconds. For example, for 1 hour, enter 3600000. Save the changes and close Notepad.

To zoom in on a portion of the curve, double-click in the chart at each point that you want to expand. The chart will display the portion you selected.

Adjusting the Curve Amplitude Scale (Y-axis)

5-19.

Complete the following procedure to adjust the curve amplitude to a fixed scale (Y-axis).

1. Uncheck Preferences | Dynamic Autoscale.
2. Double-click the Curve icon at the right side of the chart to open the curve preference dialog box (below). Enter the desired fixed scale in the Scale High and Low text boxes. Click OK. For more information on the curve preference dialog box, see "Curve Preferences."

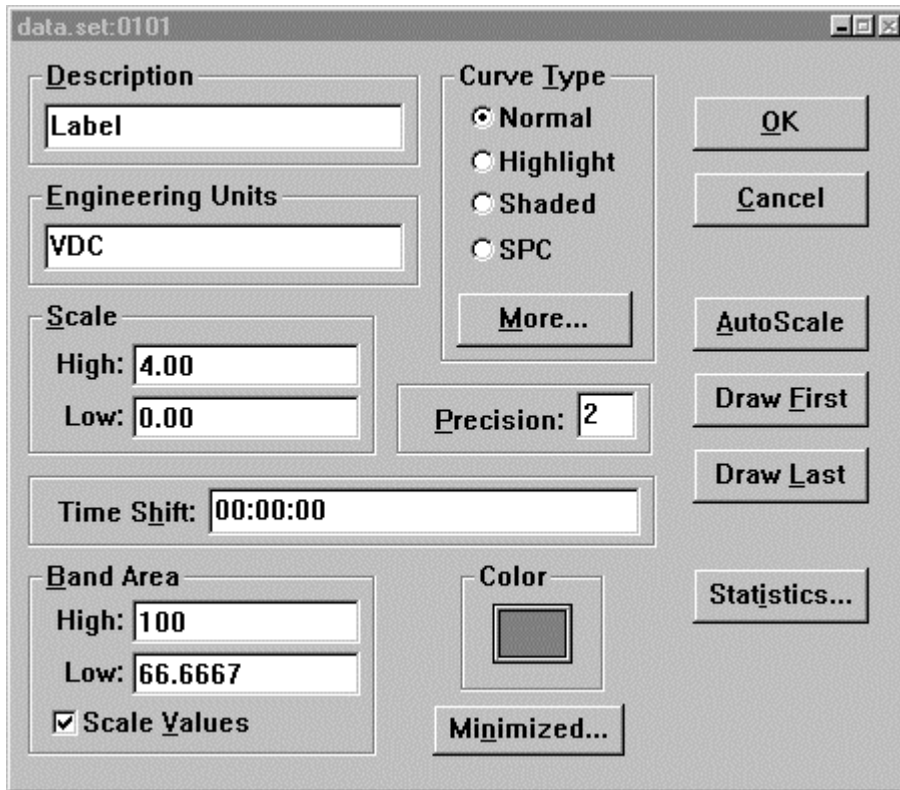

ds133s.bmp

Configuring the Curve Status Display

5-20.

Complete the following procedure to select the elements of the Curve Status display. The Curve Status display is the window at the bottom of the chart containing the parameter information of the curves. Toggle Curve Status on and off with the Curve Status Window button on the Control Bar. (See "Using the Trend Link Control Bar.")

1. Select Edit | Curve Status Info to open the Curve Status Information dialog box (below).

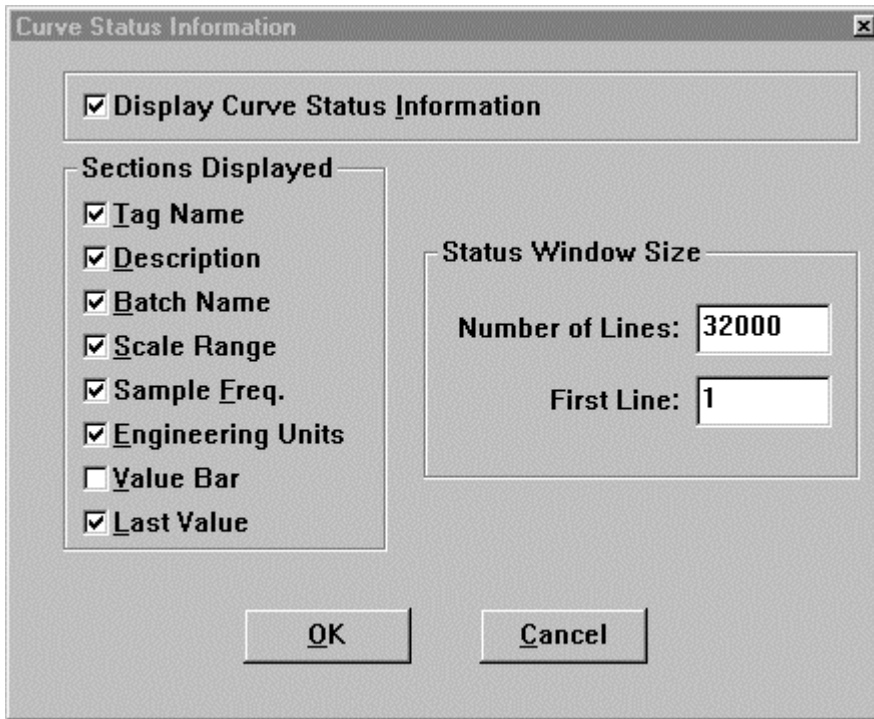

ds134s.bmp

2. Select the desired features of the Curve Status display by checking or unchecking each of the Sections Displayed listings. Click OK.

Curve Preferences

5-21.

Complete the following procedure to select the curve preferences. You can customize various attributes of each curve on the chart. For example, you can change the color, add a fixed range, and position one curve on top of another.

1. Select Curve | Curve Information to open the Curve Information dialog box.

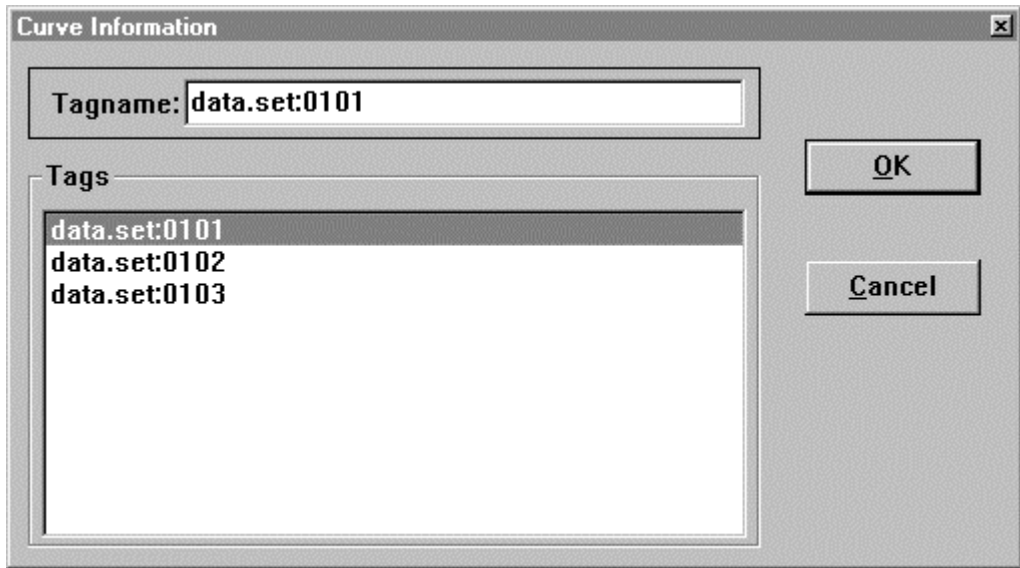

ds135s.bmp

2. Click on the desired curve listed in the Tags box, which will then appear in the Tagname box. Click OK to open the Curve Parameters box (below). (You can also open this dialog box directly by double-clicking the Curve icon.)

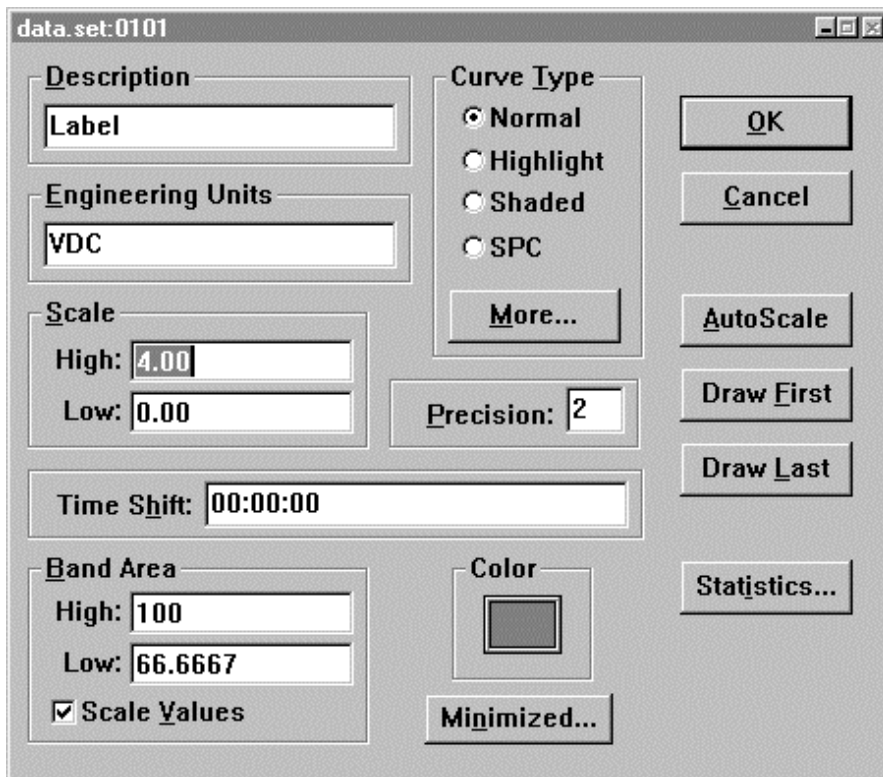

ds136s.bmp

- The tag name of the selected curve appears in the dialog box caption. Each dialog box entry has the following characteristics:

Description This entry will be initialized with the string entered in NetDAQ Logger for the channel label. (See "Assigning Channel Labels" in Chapter 3.)

Engineering Units This entry will be initialized with the string entered in NetDAQ Logger for the units label. Enter the Engineering Units characters in NetDAQ Logger as a units label. (See "Selecting Analog Channel Functions" and "Selecting Computed Channel Functions" in Chapter 3.)

Scale The High and Low entries set the curve's vertical scale. (Trend Link ignores the Scale entries if you have checked Preferences | Dynamic AutoScale.)

Band Area The High and Low entries define the portion of the curve window used for the display of the curve. Band values of 100 and 0 represent the whole curve window, while values of 50 and 0 represent the bottom half of the curve window. If you check Scale Values, the band bars displayed on

the left side of the curve window will include a display of scale values. Otherwise, a band without numbers will appear.

Curve Type Select the type of curve: normal, highlight, shaded, or SPC (Statistical Processing Control). If you enabled the NetDAQ Logger channel alarm values, the default curve type is "highlighted" and Trend Link sets limit values according to the alarm values.

Precision refers to the number of digits appearing to the right of the decimal point (Curve Status window and Band Bars. For example, a Precision entry of 1 would show values of 70.0 and 80.0 (maximum entry is 7, showing values of 70.0000000 and 80.0000000.)

Color Click here to select the color of the curve trace.

More Button Click to open the Curve Options dialog box for the Curve Type selected.

Minimized Button Click to select display options when the dialog is minimized. A minimized dialog becomes a floating window displaying various types of information about the curve (tag name, last data value, etc.)

AutoScale Button Click to autoscale the scale values based on the current data in view in the curve window.

Draw First Button This causes the curve to be drawn on the top over all other curves.

Draw Last Button This cause the curve to be drawn on the bottom under all other curves.

Statistics Button Opens the display for the statistics of the curve, including Histogram, Box Plot, Sum, Mean, and Standard Deviation values.

4. After making your selections in the dialog box, click OK or minimize the dialog.

Background Preferences

5-22.

Complete the following procedure to select the background preferences. Background preferences select the curve background color and grid appearance.

1. Select the Preferences | Background to open the Background Preferences dialog box (below).

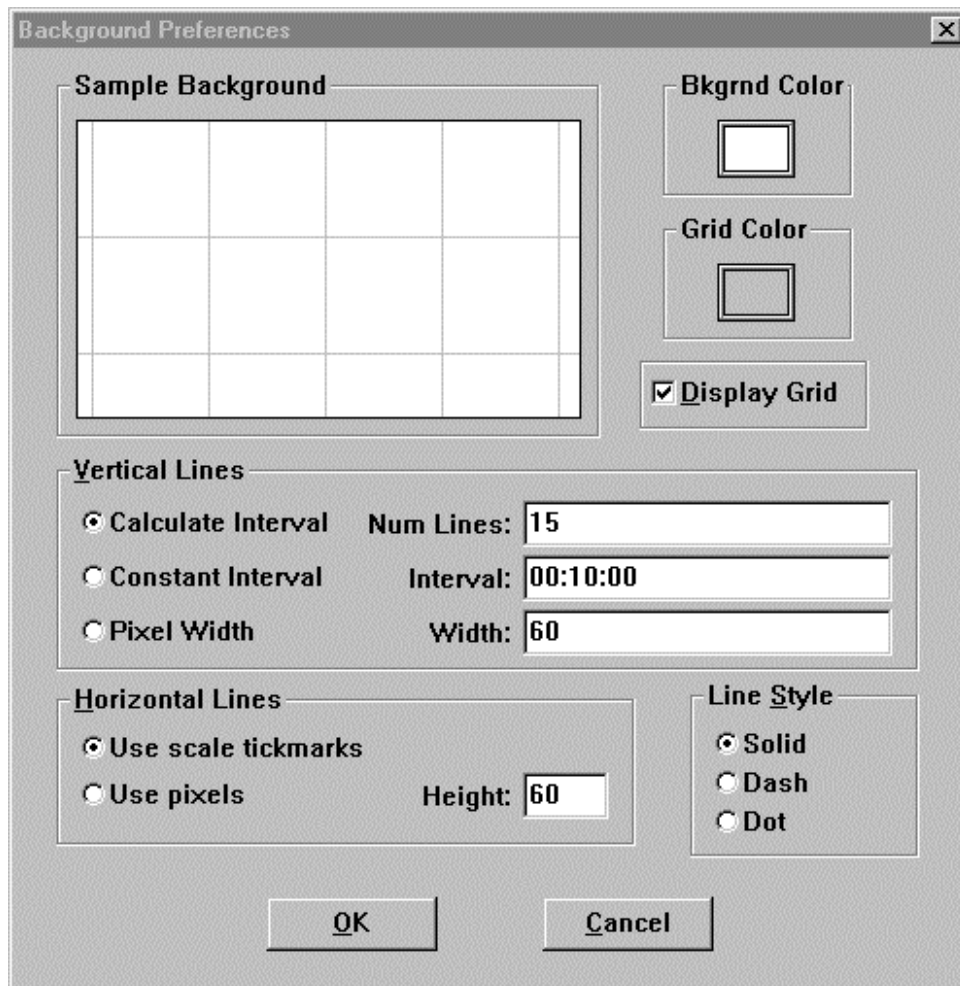

ds137s.bmp

2. The dialog box entries are as follows:
 - **Bkgrnd Color:** Choose the background color.
 - **Grid Color:** Choose the grid color.
 - **Display Grid:** This is the same as selecting Grid Lines On/Off on the Control Bar.
 - **Calculate Interval:** Select this option to enter the number of vertical grid lines to display. Trend Link calculates the time interval represented by each grid line so that the desired number of grid lines appear on the display.

- **Constant Interval:** Select this option to enter the exact time interval that a vertical grid line should represent.
 - **Pixel Width:** Select this option to enter the distance between vertical grid lines in pixels.
 - **Use scale tickmarks:** If you select this option, horizontal grid lines draw to match the tickmark labels on the band bars.
 - **Use Pixels:** If you select this option, you can enter the distance between horizontal grid lines in pixels.
3. After making your selections in the Background Preferences dialog box, click OK.

Real Time Frequency Update

5-23.

Complete the following procedure to modify the frequency update period for the real time display. The default (and minimum time) is 1 second. The maximum entry is 1410065 seconds.

1. Select Preferences | Real Time Freq to open the Real Time Interval dialog box.

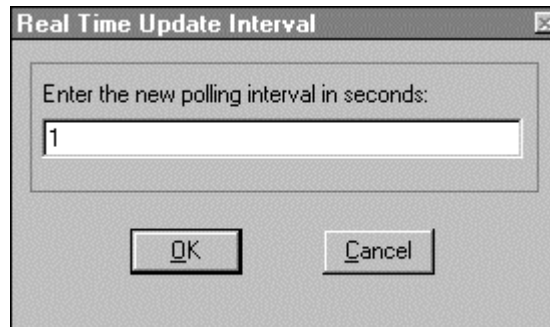

ds138s.bmp

2. Enter the desired number of seconds for the real time interval. The range is 1 to 1410065. You cannot enter fractions of seconds. Click OK.

Adding or Changing the Chart Title

5-24.

Complete the following procedure to add or change the title of the chart at the very top of the chart window. By convention, the title is the name of the Trend Link file with the *.cht extension, for example, data.cht. However, you can use this procedure to enter any custom title.

1. Select Preferences | Chart Title to open the Chart Title dialog box. Enter the chart title name in the text box, for example, `station one`. Click OK.
2. Observe that the entered text appears at the top of the chart in the Title Bar.

Using the Note System

5-25.

Complete the following procedure to add a text note to a curve. You can add notes to an historical curve to comment on a particular event (voltage spike, gap in the data, etc.).

1. Select Preferences | Note System to enable the Note icon on the Control Bar.
2. To add a note to a point on an historical curve, drag the Note icon to a point on the curve and release. When you release the note, a text box for the note opens and displays the time and date where the note will be positioned on the curve.
3. Enter the desired text (up to 1024 characters) in the text box, then click OK.
4. When the message “Add note permanently to curve?” appears, click Yes.
5. As a test, double-click the Note icon you just created to view the note text. Click OK.

Printing a Chart

5-26.

Complete the following procedure to print a Trend Link chart. Trend Link prints only the displayed portion of the chart.

1. Bring into view the portion of the chart you wish to print.
2. Select File | Print to open the Print Options dialog box (below).

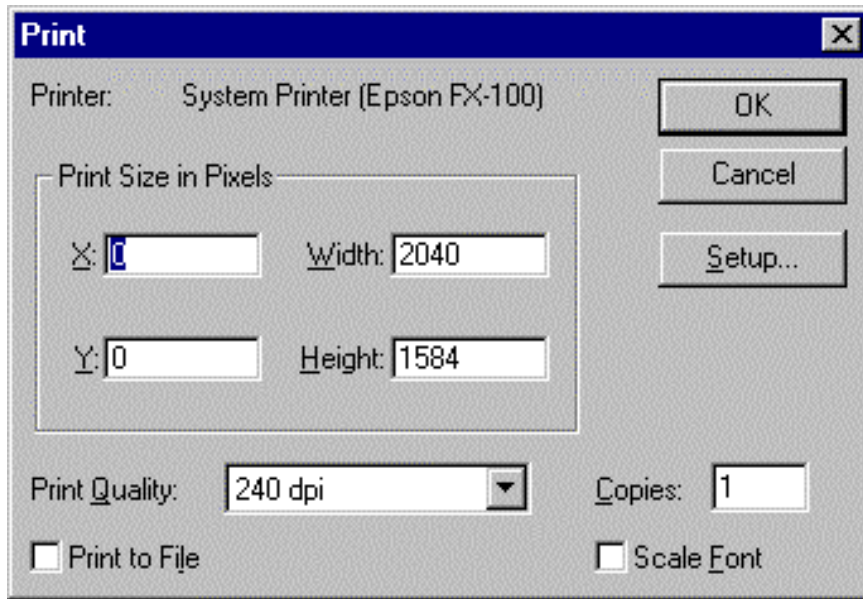

ds140s.bmp

You can position and size the printed chart by entering X and Y Offsets and Width and Height settings. The X and Y Offsets specify the position of the upper-left corner of the printed page, and the Width and Height determine the size of the printed chart. If you enter impossible values, Trend Link prints a default (full-page) chart.

For example, X=500, Y=750, and Width=1400, Height=1650 results in the following printed chart:

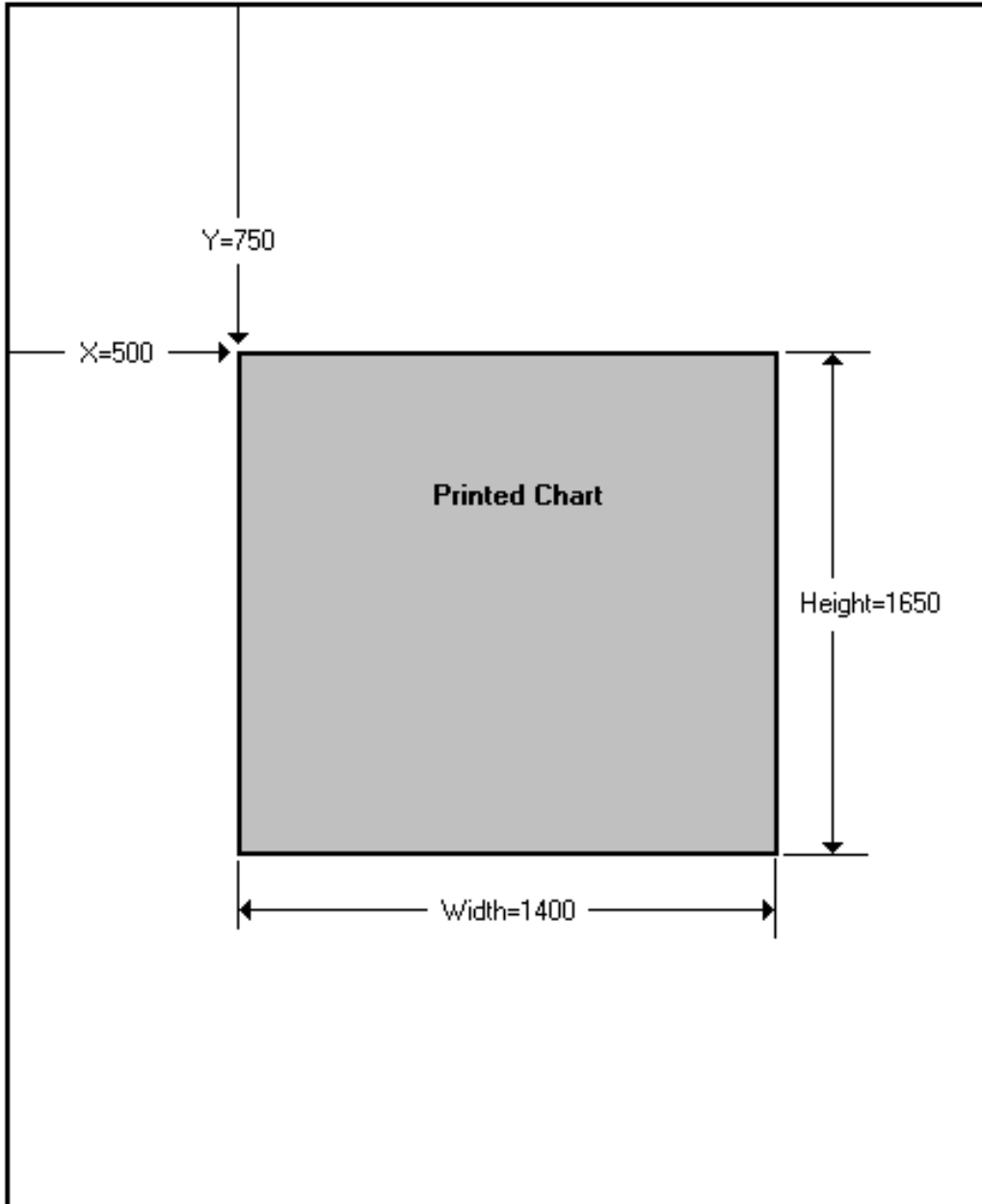

ds141f.bmp

Click OK to print the chart.

Chapter 6

Maintenance

Contents		Page
6-1.	Introduction	6-3
6-2.	Self-Test Diagnostics and Error Codes	6-3
6-3.	Cleaning.....	6-4
6-4.	Fuse Replacement.....	6-4
6-5.	Performance Test.....	6-6
6-6.	Configuring the Performance Test Setup.....	6-6
6-7.	Initializing the Performance Test Setup.....	6-9
6-8.	Accuracy Performance Tests	6-11
6-9.	Volts DC Accuracy Test (2640A)	6-11
6-10.	Volts DC Accuracy Test (2645A)	6-12
6-11.	Volts AC Accuracy Test.....	6-13
6-12.	Frequency Accuracy Test.	6-14
6-13.	Analog Channel Integrity Test.....	6-15
6-14.	Computed Channel Integrity Test.....	6-15
6-15.	Thermocouple Temperature Accuracy Test	6-16
6-16.	Open Thermocouple Response Test.....	6-16
6-17.	2-Wire Resistance Accuracy Test (2640A).....	6-17
6-18.	2-Wire Resistance Accuracy Test (2645A).....	6-18
6-19.	4-Wire Resistance Accuracy Test (2640A).....	6-20
6-20.	4-Wire Resistance Accuracy Test (2645A).....	6-23
6-21.	RTD Temperature Accuracy Test (Resistance) (2640A)	6-24
6-22.	RTD Temperature Accuracy Test (Resistance) (2645A)	6-25
6-23.	RTD Temperature Accuracy Test (DIN/IEC 751 RTD)	6-25
6-24.	Digital Input/Output Tests	6-26
6-25.	Digital I/O Output Test.....	6-26
6-26.	Digital Input Test.....	6-27
6-27.	Totalizer Tests.....	6-28
6-28.	Totalizer Count Test	6-28

6-29.	Totalizer Sensitivity Test	6-28
6-30.	Master Alarm Output Test.....	6-29
6-31.	Trigger Input Test.....	6-30
6-32.	Trigger Output Test	6-30
6-33.	Calibration	6-31
6-34.	Adding Calibration to the Utilities Menu.....	6-32
6-35.	Instrument Calibration Dialog Box	6-33
6-36.	Calibration Steps Dialog Box	6-33
6-37.	Variations in the Display	6-34
6-38.	Service.....	6-34
6-39.	Replacement Parts.....	6-36

Introduction

6-1.

Maintenance for the 2640A/2645A instruments is limited to self-test error code explanations, cleaning, fuse replacement, performance test, calibration, and a listing of replacement parts. A *Service Manual* (PN 942615) is available for purchase.

Self-Test Diagnostics and Error Codes

6-2.

Self-test diagnostics are performed each time the instrument is powered up. Any errors encountered during this initial 5-second period are reported on the front panel, as shown below.

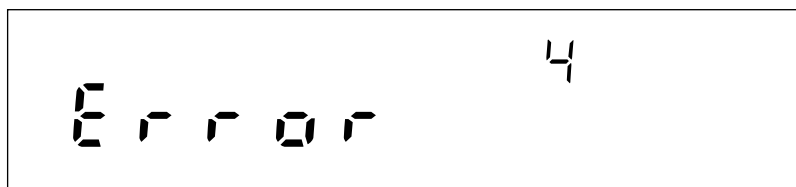

If you encounter an error code, refer to Table 6-1 for a brief description of the error. For all errors, try cycling the instrument power. If the error persists and you intend to repair the instrument yourself, refer to the *Service Manual*, PN 942615. Otherwise, package the instrument securely (using the original container, if available), and mail it to the nearest Fluke Service Center. Include a description of the problem. Fluke assumes no responsibility for damage in transit.

Table 6-1. Self-Test Error Codes

Error Code	Error Description
1	Boot ROM Checksum Error
2	Instrument ROM Checksum Error
3	Internal RAM Test Failed
4	Display Power-Up Test Failed
5	Display Not Responding
6	Calibration Constants Corrupted
7	A-D Not Responding
8	A-D Self-Test Failed
9	A-D Zero Offset Test Failed
10	A-D Reference Balance Test Failed
11	A-D Overload Detection Test Failed
12	A-D Open Thermocouple Detection Test Failed
13	Communication Parameters (e.g., baud, IP address) Corrupted
14	Ethernet Address Corrupted
15	Internal RAM Constants Corrupted
16	Ethernet Chip Test Failed
17	Uncalibrated or Calibration Incomplete

Cleaning

6-3.

Warning

Keep the instrument dry to avoid electrical shock to personnel or damage to the instrument. To prevent damage, never apply solvents to the instrument housing.

Wipe the instrument with a cloth lightly dampened with water or mild detergent. Do not use aromatic hydrocarbons, chlorinated solvents, or methanol-based fluids.

Fuse Replacement

6-4.

The instrument uses a 15/100 ampere, 250V, time delay line fuse in series with the power supply. To replace the fuse, refer to Figure 6-1 and the following procedure:

Warning

To avoid electrical shock, do not operate the instrument without the cover properly installed.

1. Disconnect *all* rear panel cables to the instrument power, Universal Input Module, and I/O connectors.
2. Invert the instrument on a protective surface and remove the four 1/4-inch 6-32 Phillips-head screws on the bottom of the case.
3. Turn the instrument upright and remove the two 1/2-inch 6-32 Phillips-head screws from the rear panel bezel.
4. Remove the rear panel bezel and case assembly. Do not touch any internal parts of the instrument!
5. Locate the fuse holder at the back of the chassis near the power input connector. Using a non-metallic tool, carefully pry the fuse from the holder.
6. Insert the new fuse into the holder. (You *must* use a 15/100 ampere, 250V time delay line fuse replacement.)
7. Reinstall the case to its original position (the front has two rubber feet).
8. Reinstall the rear panel bezel (rubber feet towards the bottom) and attach it with the two 1/2-inch 6-32 phillips-head screws.
9. Invert the instrument on the protective surface and reinstall the four 1/4-inch 6-32 screws on the bottom securing the case.
10. Reinstall the cables removed in Step 1.

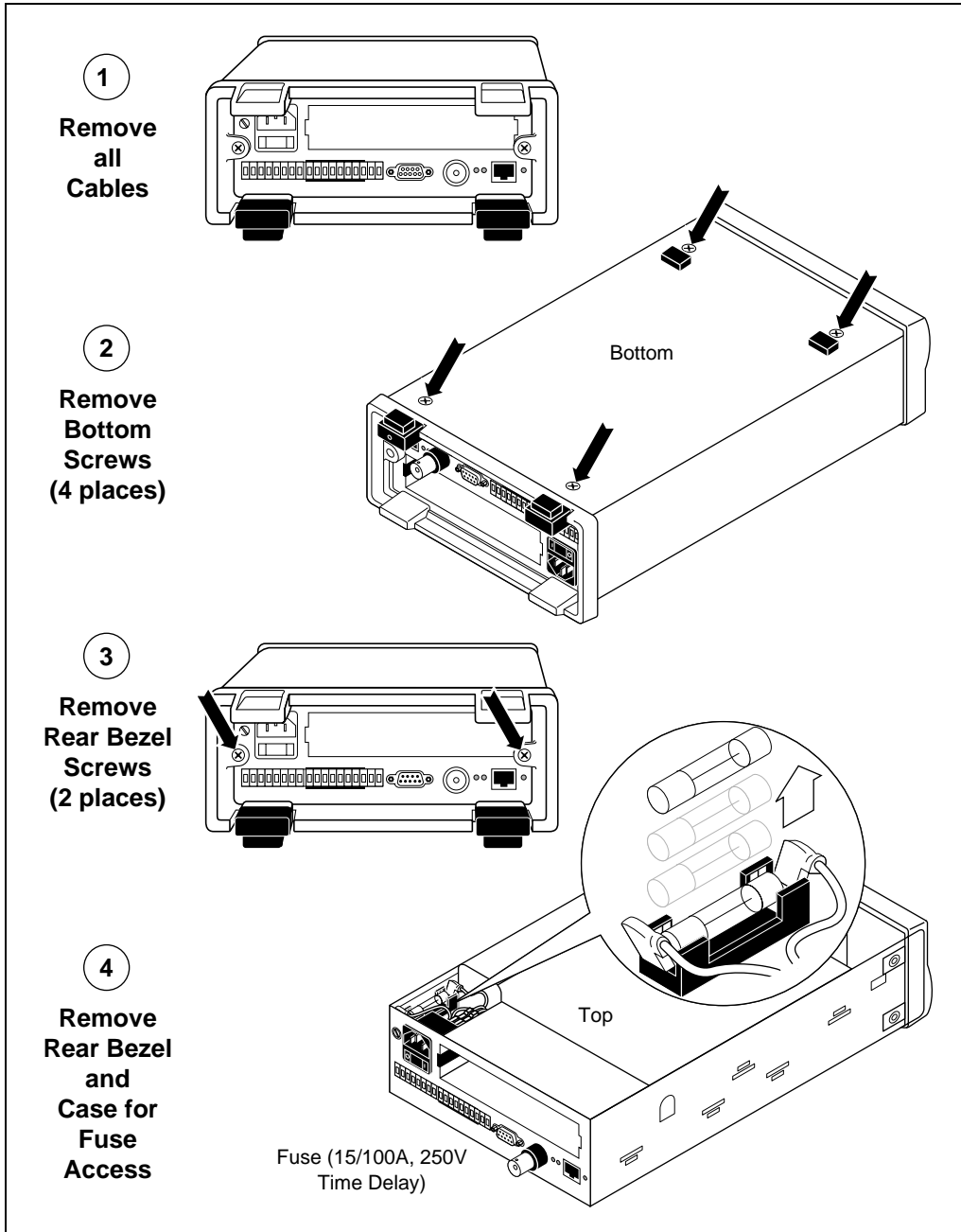

Figure 6-1. Replacing the Fuse

Performance Test

6-5.

When received, the 2640A/2645A is calibrated and in operating condition. The following Performance Test procedures are provided for acceptance testing upon initial receipt or to verify correct instrument operation. The performance tests *must* be performed in sequence.

If the instrument fails a performance test, the instrument requires service or repair. To perform these tests, you will need a Fluke 5700A Multifunction Calibrator and several other pieces of equipment meeting the minimum specifications given in Table 6-2.

Each of the measurements listed in the following steps assume the instrument is being tested after a 1/2 hour warm-up, in an environment with an ambient temperature of 18 to 28°C, and a relative humidity of less than 70%.

Warning

The 2640A/2645A instrument contains high voltages that can be dangerous or fatal. Only qualified personnel should attempt to service the instrument.

Configuring the Performance Test Setup

6-6.

Configure the performance test setup as described below. The performance test requires a complete network connection between the host computer and instrument under test, including a host computer Ethernet interface and installation of NetDAQ Logger. If you have not yet configured and tested a network connection for the host computer and instrument, complete the appropriate installation procedure for your network configuration before conducting any performance testing.

1. **Connect the Instrument and the Host Computer** Connect the supplied 50-ohm coaxial cable, with a BNC "T" or "Y" and 50-ohm terminator, between the host computer BNC Ethernet port and the instrument BNC Ethernet port. The 50-ohm terminator with the ground lead is used at the instrument with the terminator ground lug connected to the ground terminal adjacent to the BNC port (Figure 6-2). See Chapter 2 for other interconnection methods.
2. **Connect the 5700A to Channel 1** Connect a cable from the Output VA HI and LO connectors of the 5700A to the Universal Input Module terminals for channel 1 connecting the 5700A HI to terminal H and LO to terminal L. Insert the Universal Input Module into the instrument under test (Figure 6-3).

Table 6-2. Recommended Test Equipment

Instrument Type	Minimum Specifications	Recommended Model	
Multifunction Calibrator	DC Voltage:		
	Range: 90 mV to 300V dc		
	Accuracy: 0.002%		
	AC Voltage:		
	Frequency	Voltage	Accuracy
	1 kHz	29 mV to 300V	0.05%
	100 kHz	15 mV to 300V	0.5%
	Frequency:		
	10 kHz	1V rms	0.01%
	Ohms:		
	Ohms	Accuracy	
	190Ω	0.005%	
	1.9 kΩ	0.005%	
	19 kΩ	0.005%	
190 kΩ	0.005%		
1.9 MΩ	0.005%		
Mercury Thermometer	0.02°C Resolution	Princo ASTM-56C	
Thermocouple Probe	Type T	Fluke P20T	
Oil/Water Bath	Thermos bottle and cap		
Digital Multimeter	General Purpose Measurement	Fluke 77	
Signal Generator	Sine wave. 0.5 to 1V rms, 10 Hz to 5 kHz	Philips PM5193	
Alternative Equipment List			
Instrument Type		Recommended Model	
DC Voltage Calibrator		Fluke 5440B	
DMM Calibrator		Fluke 5100B (AC Volts Only)	
Function/Signal Generator		Philips PM5139 or HP33120A	
Decade Resistance Source		General Resistance RDS 66A	

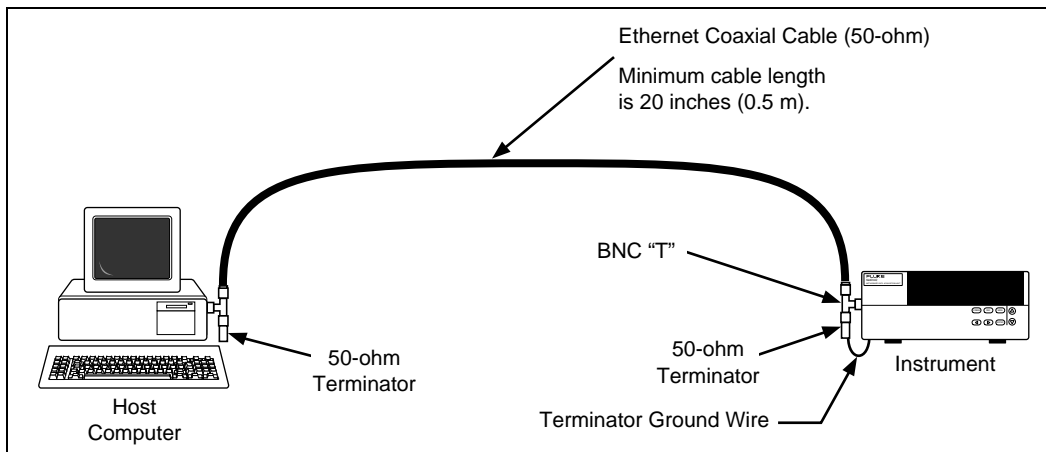

Figure 6-2. Performance Test Setup

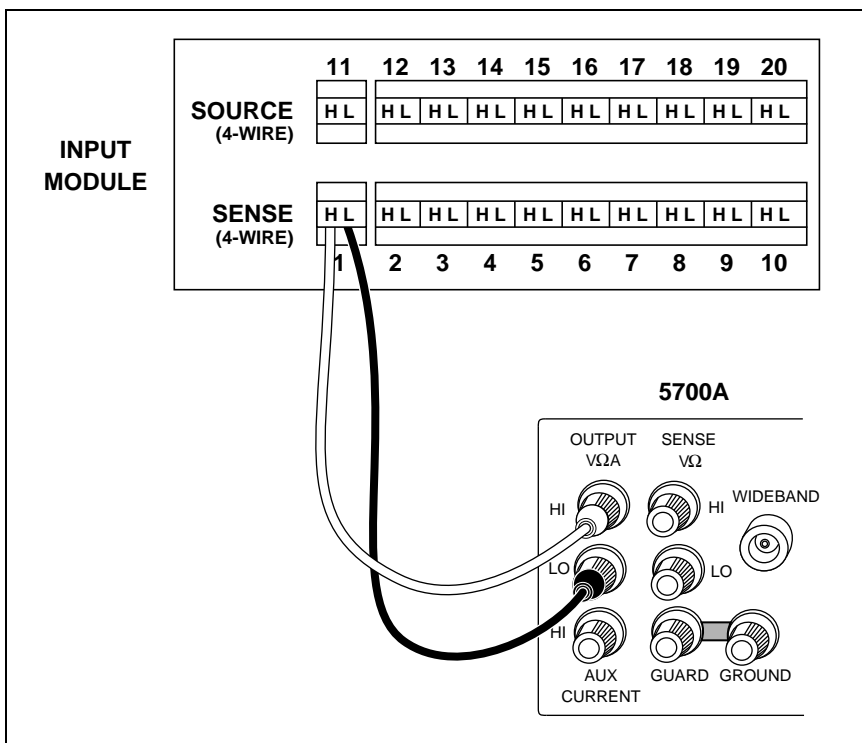

Figure 6-3. 2-Wire Connections to 5700A

Initializing the Performance Test Setup

6-7.

Complete the following procedure to initialize the performance test setup. It is assumed you have configured the host computer and instrument as described in "Configuring the Performance Test Setup" (above). Testing begins with the instrument and host computer unpowered. This assures that at power-up self-tests are completed successfully, the correct host computer Ethernet port is activated, the host computer configuration is accurately reflected, and other background operations are completed. This procedure clears the instrument of any existing BCN, Line Frequency, and Network settings.

1. **Apply Instrument Power with Configuration Reset** Hold down the COMM key on the instrument front panel and apply power to the instrument. After the instrument beeps and momentarily displays "rESET" (Reset), release the COMM key. If any self-test errors are reported on the front panel display, refer to "Self-Test Diagnostics and Error Codes" in this chapter. Configuration Reset sets the instrument to the default parameters: BCN=1, Line Frequency=60, and Isolated Network.
2. **Set the Line Frequency** If the ac power applied to your instrument is 60 Hz (default), continue to Step 3. If the ac power applied to your instrument is 50 Hz, complete this step.

Press the COMM key for three seconds, until a beep is heard and the SET annunciator in the display is lit. Press the up/down arrow keys until Line (Line Frequency) is displayed in the primary display. Press the ENTER key. Press the up/down arrow keys until 50 (50 Hz) is displayed in the primary display. Press the ENTER key.

3. **Apply Host Computer Power** Apply power to the host computer.
4. **Open NetDAQ Logger** You can use Start | Programs, double-click on a setup file shortcut on the Windows desktop, or double-click on a setup file name in the Windows Explorer or File Manager.
5. **Add Instrument** Select the Communications Config command from the Setup menu to open the Communications Configuration File dialog box. Observe the Instruments on Network list. If the list includes instrument 01 with the correct model number (model 2640A or model 2645A), continue to Step 6.

If instrument 01 is listed but with the wrong model number, select (highlight) the instrument on the Instruments on Network list and click the Modify button. Select the correct model and click OK. If instrument 01 is not listed, click the Add button and add instrument 01 with the correct model number. Click OK.

6. **Verify Communications** With the Communications Configuration File dialog box still open, select instrument 01 on the Instruments on Network list and click the Verify button. The message Connection Successful! is returned for successful communications between the instrument and host computer. If you receive an error message, refer to "Error and Status Messages" in Appendix J. Click OK in the message box and then the Close button in the Communications Configuration File dialog box to return to the Main Window.
7. **Configure Icon** Note the Icon Bar in the Main Window. If the Icon Bar shows instrument 01, complete Delete Instrument Icon below. If it does not show instrument 01, complete Create Instrument Icon below.

Delete Instrument Icon Select Instrument 01 in the Icon Bar and then select Delete Instrument Icon from the Setup menu. Click Yes in the warning message. Complete Create Instrument Icon below. This sequence causes NetDAQ Logger to reset the current setup for Instrument 01 to default settings.

Create Instrument Icon Select the Create Instrument Icon from the Setup menu. Select instrument 01 on the Available Instruments List. Click OK.

8. **Select Reading Rate and Trigger Out** Select Setup | Instrument Configuration to open the Instrument Configuration dialog box. Select Reading Rate = Slow, and check the Trigger Out box. Click OK to return to the Main Window.
9. **Connect DIGITAL I/O Test Leads** Remove the 10-position DIGITAL I/O connector from the instrument rear panel or from the connector kit supplied with the instrument. Connect a test lead to each DIO line 0 to 7, plus a test lead to the Σ (Totalizer) input and the common GND line. Reinstall the DIGITAL I/O connector. (See "Digital I/O Connections" in Chapter 2 of this manual)
10. **Connect ALARM/TRIGGER I/O Test Leads** Remove the 8-position ALARM/TRIGGER I/O connector from the instrument rear panel. Connect a test lead to each line, MA (Master Alarm), TO (Trigger Output), TI (Trigger Input), plus a test lead to the common GND line. (See "Alarm/Trigger I/O Connections" in Chapter 2 of this manual.)

Accuracy Performance Tests

6-8.

This accuracy performance test assumes you have completed "Initializing the Performance Test Setup" above. Do not begin this test until the instrument has been temperature stabilized for a minimum of 30 minutes. Do not use the instrument front panel monitor function for performance testing; use the higher resolution Spy window at the host computer, as specified in procedures. The Accuracy Performance Tests include the following:

- Volts DC Accuracy Test
- Volts AC Accuracy Test
- Frequency Accuracy Test
- Analog Channel Integrity Test
- Computed Channel Integrity Test
- Thermocouple Temperature Accuracy Test
- Open Thermocouple Response Test
- 2-Wire Resistance Accuracy Test
- 4-Wire Resistance Accuracy Test
- RTD Temperature Accuracy Test (Resistance Source)
- RTD Temperature Accuracy Test (DIN/IEC 751 RTD Source)

Specific tests for current dc are not included since these functions are derived from volts dc.

Volts DC Accuracy Test (2640A)

6-9.

Complete the following procedure to test the accuracy of the volts dc function for the 2640A. Measurement accuracy applies to all channels, not just the channel used for the test.

1. **Configure Channel 1 for Volts DC** In NetDAQ Logger, configure channel 1 for volts dc, 90 mV range. (See "Configuring Analog Channel Functions" in Chapter 3 of this manual.)
2. **Open Spy Window** Select the Spy command from the Utilities menu. Select channel 0101 (instrument 01, channel 01) from the Channel list. Click OK to open the Spy window.

3. **Verify Accuracy** Configure the 5700A for the output values below and verify the Spy window measurement is between the minimum and maximum values. Change the channel 1 range as required (see Step 1).

Volts DC Range	5700A Output	Minimum Reading	Maximum Reading
90 mV	Short Circuit (Zero)	-0.000008V	+0.000008V
90 mV	+90 mV	+0.089980V	+0.090020V
90 mV	-90 mV	-0.090020V	-0.089980V
300 mV	Short Circuit (Zero)	-0.000017V	+0.000017V
300 mV	+300 mV	+0.299944V	+0.300056V
300 mV	-300 mV	-0.300056V	-0.299944V
3V	Short Circuit (Zero)	-0.00015V	+0.00015V
3V	+3V	+2.99946V	+3.00054V
3V	-3V	-3.00054V	-2.99946V
30V	Short Circuit (Zero)	-0.0017V	+0.0017V
30V	+30V	+29.9944V	+30.0056V
30V	-30V	-30.0056V	-29.9944V
300V	Short Circuit (Zero)	-0.017V	+0.017V
300V	+300V	+299.944V	+300.056V
300V	-300V	-300.056V	-299.944V

4. **Close Spy Window.**

Volts DC Accuracy Test (2645A)

6-10.

Complete the following procedure to test the accuracy of the volts dc function for the 2645A. Measurement accuracy applies to all channels, not just the channel used for the test.

1. **Configure Channel 1 for Volts DC** In NetDAQ Logger, configure channel 1 for volts dc, 90 mV range. (See "Configuring Analog Channel Functions" in Chapter 3 of this manual.)
2. **Open Spy Window** Select the Spy command from the Utilities menu. Select channel 0101 (instrument 01, channel 01) from the Channel list. Click OK to open the Spy window.

3. **Verify Accuracy** Configure the 5700A for the output values below and verify the Spy window measurement is between the minimum and maximum values. Change the channel 1 range as required (see Step 1).

Volts DC Range	5700A Output	Minimum Reading	Maximum Reading
90 mV	Short Circuit (Zero)	-0.000023V	+0.000023V
90 mV	+90 mV	+0.089965V	+0.090035V
90 mV	-90 mV	-0.090035V	-0.089965V
300 mV	Short Circuit (Zero)	-0.00005V	+0.00005V
300 mV	+300 mV	+0.29991V	+0.30009V
300 mV	-300 mV	-0.30009V	-0.29991V
3V	Short Circuit (Zero)	-0.0004V	+0.0004V
3V	+3V	+2.9992V	+3.0008V
3V	-3V	-3.0008V	-2.9992V
30V	Short Circuit (Zero)	-0.005V	+0.005V
30V	+30V	+29.991V	+30.009V
30V	-30V	-30.009V	-29.991V
50V	Short Circuit (Zero)	-0.04V	+0.04V
50V	+50V	+49.95V	+50.05V
50V	-50V	-50.05V	-49.95V

4. **Close Spy Window.**

Volts AC Accuracy Test

6-11.

Complete the following procedure to test the accuracy of the volts ac function for both the 2640A and 2645A. Measurement accuracy applies to all channels, not just the channel used for the test.

1. **Configure Channel 1 for Volts AC** In NetDAQ Logger, configure channel 1 for volts ac, 300 mV range. (See “Configuring Analog Channel Functions” in Chapter 3 of this manual.)
2. **Open Spy Window** Select the Spy command from the Utilities menu. Select channel 0101 (instrument 01, channel 01) from the Channel list. Click OK to open the Spy window.

3. **Verify Accuracy** Configure the 5700A for the output values below and verify the Spy window measurement is between the minimum and maximum values. Change the channel 1 range as required (see Step 1).

Volts AC Range	5700A Output	Minimum Reading	Maximum Reading
300 mV	20 mV@1 kHz	0.0197V	0.0203V
300 mV	20 mV@100 kHz	0.0185V	0.0215V
300 mV	300 mV@1 kHz	0.29885V	0.30115V
300 mV	300 mV@100 kHz	0.2845V	0.3155V
3V	3V@1 kHz	2.9885V	3.0115V
30V	30V@1 kHz	29.885V	30.115V
300V [2640A only]	300V@1 kHz	298.85V	301.15V

4. **Close Spy Window.**

Frequency Accuracy Test

6-12.

Complete the following procedure to test the accuracy of the frequency function for the 2640A and 2645A. Measurement accuracy applies to all channels, not just the channel used for the test.

1. **Configure Channel 1 for Frequency** In NetDAQ Logger, configure channel 1 for frequency. There is no range selection for frequency as all frequency measurements use Autoranging. (See "Configuring Analog Channel Functions" in Chapter 3 of this manual.)
2. **Open Spy Window** Select the Spy command from the Utilities menu. Select channel 0101 (instrument 01, channel 01) from the Channel list. Click OK to open the Spy window.
3. **Verify Accuracy** Configure the 5700A for the output values below and verify the Spy window measurement is between the minimum and maximum values. Change the channel 1 range as required (see Step 1).

Frequency Range	5700A Output	Minimum Reading	Maximum Reading
Autorange Only	1V@10 kHz	9.994 kHz	10.006 kHz

4. **Close Spy Window.**

Analog Channel Integrity Test

6-13.

Complete the following procedure to test the integrity of each analog channel (2 to 20) to verify each analog channel is capable of making measurements.

1. **Configure Channel for Ohms** In NetDAQ Logger, configure channels 2 (then 3, then 4, etc. as this step is repeated) to 20 for Ohms-2W, 300 range [2640A] or 30K range [2645A]. (See "Configuring Analog Channel Functions" in Chapter 3 of this manual.)
2. **Connect Test Leads** Remove the Universal Input Module from the instrument, disconnect the test leads and connect them to the channel under test (starting with channel 2). Reinstall the Universal Input Module in the instrument.
3. **Open Spy Window** Select the Spy command from the Utilities menu. Select the analog channel under test. Click OK to open the Spy window.
4. **Verify Reading** Alternately open and short the test leads observing the measurement for the analog channel under test in the Spy window shows Overload for opened leads and very low resistance for shorted leads (less than 10 ohms for the 2640A, or less than 1k ohms for the 2645A).
5. **Repeat Test for each Channel** Repeat steps 2 to 4 for each channel (3, 4, 5, and so forth to channel 20).

Computed Channel Integrity Test

6-14.

Complete the following procedure to test the integrity of each computed channel (21 to 30) to verify each computed channel is capable of making measurements.

1. **Configure Channels 1 and 2 for Ohms** In NetDAQ Logger, configure channels 1 and 2 for Ohms-2W, 30k range. (See "Configuring Analog Channel Functions" in Chapter 3 of this manual)
2. **Configure Channel for Average** In NetDAQ Logger, configure channels 21 to 30 for ChanA - ChanB (Difference) with the difference channels being analog channel 1 and analog channel 2. (See "Configuring Computed Channel Functions" in Chapter 3 of this manual.)
3. **Connect Test Leads** Remove the Universal Input Module from the instrument and connect test leads to channels 1 and 2. Reinstall the Universal Input Module in the instrument.
4. **Open Spy Window** Select the Spy command from the Utilities menu. Select the computed channels 21 to 28. Click OK to open the Spy window.
5. **Verify Reading** Alternately open and short both sets of test leads observing the measurement for the computed channel under test in the Spy window shows +Overload for opened leads and very low resistance for shorted leads.
6. **Repeat Test** Repeat steps 4 to 5 for channels 29 and 30.

Thermocouple Temperature Accuracy Test

6-15.

Ensure that the Accuracy Tests (above) have been completed before performing this test.

1. **Connect a Thermocouple** Remove the Universal Input Module from the instrument and connect the supplied type T thermocouple to the channel 1 terminals with the blue lead to the H terminal and red lead to the L terminal. Reinstall the Universal Input Module.
2. **Configure Channel 1 for Thermocouples** In NetDAQ Logger, configure channel 1 for Thermocouples with Range (thermocouple type) T. (See "Configuring Analog Channel Functions" in Chapter 3 of this manual.)
3. **Open Spy Window** Select the Spy command from the Utilities menu. Select analog channel 01. Click OK to open the Spy window.
4. **Verify Accuracy** Insert the thermocouple and a mercury thermometer in a room-temperature bath. Allow 20 minutes for thermal stabilization. The value displayed on the mercury thermometer should equal the value in the Spy Window $\pm 0.5^{\circ}\text{C}$ (2640A) or $\pm 0.95^{\circ}\text{C}$ (2645A) plus any sensor inaccuracies.
5. **Close Spy Window.**

Open Thermocouple Response Test

6-16.

This test checks the Open Thermocouple response.

1. **Connect an 820 Ohm Test Resistor** Remove the Universal Input Module from the instrument and connect an 820 ohm resistor to the channel 1 terminals. Reinstall the Universal Input Module.
2. **Configure Channel 1 for Thermocouples** In NetDAQ Logger, configure channel 1 for Thermocouples with Range (thermocouple type) K. (See "Configuring Analog Channel Functions" in Chapter 3 of this manual.)
3. **Open Spy Window** Select the Spy command from the Utilities menu. Select analog channel 1. Click OK to open the Spy window. The value displayed should approximate the ambient temperature.
4. **Connect a 10k Ohm Test Resistor** Remove the Universal Input Module from the instrument and connect a 10k ohm resistor to the channel 1 terminals to simulate an open thermocouple condition. Reinstall the Universal Input Module.
5. **Verify Open Thermocouple** The Spy window indicates an open thermocouple detect condition by displaying Open TC in place of a temperature reading.
6. **Close Spy Window.**

2-Wire Resistance Accuracy Test (2640A)

6-17.

Complete the following procedure to test the accuracy of the resistance function for the 2640A using 2 terminals. Measurement accuracy applies to all channels, not just the channel used for the test. (The 4-wire resistance accuracy test is more rigorous and you may wish to skip this step and continue to “4-Wire Resistance Accuracy Test.”)

1. **Connect the Resistance Source to Channel 1** Remove the Universal Input Module from the instrument and connect a cable from the Decade Resistance Source to the Universal Input Module terminals for channel 1. Reinstall the Universal Input Module. You may also use the 5700A resistance calibration output instead of the Decade Resistance Source. Tables are provided for both connections.
2. **Configure Channel 1 for Ohms** In NetDAQ Logger, configure channel 1 for Ohms-2W, 300 range. (See "Configuring Analog Channel Functions" in Chapter 3 of this manual.)
3. **Open Spy Window** Select the Spy command from the Utilities menu. Select channel 0101 (instrument 01, channel 01) from the Channel list. Click OK to open the Spy window.
4. **Verify Accuracy** Configure the Decade Resistance Source for the output values below and verify the Spy window measurement is between the minimum and maximum values. Change the channel 1 range as required (see Step 2).

Resistance Range*	Decade Resistor	Minimum Reading	Maximum Reading
300Ω	Short Circuit (Zero)	0Ω	10Ω
300Ω	290Ω	289.86Ω	300.14Ω
3 kΩ	Short Circuit (Zero)	0Ω	10.5Ω
3 kΩ	2.9 kΩ	2.8986 kΩ	2.9114 kΩ
30 kΩ	29 kΩ	28.983 kΩ	29.027 kΩ
300 kΩ	290 kΩ	289.61 kΩ	290.39 kΩ
3 MΩ	2.9 MΩ	2.8914 MΩ	2.9086 MΩ

* The resistance accuracy in this table makes allowance for up to 0.1Ω of lead wire resistance plus 0.01% decade resistance tolerance. You must add any additional lead wire resistance present in your setup to the resistance values given in this table.

Resistance Range*	5700A	Minimum Reading	Maximum Reading
300Ω	Short Circuit (Zero)	0Ω	10Ω
300Ω	190Ω	189.91Ω	200.09Ω
3 kΩ	Short Circuit (Zero)	0Ω	10.5Ω
3 kΩ	1.9 kΩ	1.8991 kΩ	1.9109 kΩ
30 kΩ	19 kΩ	18.989 kΩ	19.021Ω
300 kΩ	190 kΩ	189.75 kΩ	190.26 kΩ
3 MΩ	1.9 MΩ	1.8942 MΩ	1.9058 MΩ

* The resistance accuracy in this table makes allowance for up to 0.1Ω of lead wire resistance. You must add any additional lead wire resistance present in your setup to the resistance values given in this table..

5. Close Spy Window.

2-Wire Resistance Accuracy Test (2645A)

6-18.

Complete the following procedure to test the accuracy of the resistance function for the 2645A using 2 terminals. Measurement accuracy applies to all channels, not just the channel used for the test. (The 4-wire resistance accuracy test is more rigorous and you may wish to skip this step and continue to “4-Wire Resistance Accuracy Test.”)

1. **Connect the Resistance Source to Channel 1** Remove the Universal Input Module from the instrument and connect a cable from the Decade Resistance Source to the Universal Input Module terminals for channel 1. Reinstall the Universal Input Module. You may also use the 5700A resistance calibration output instead of the Decade Resistance Source. Tables are provided for both connections.
2. **Configure Channel 1 for Ohms** In NetDAQ Logger, configure channel 1 for Ohms-2W, 30k range. (See “Configuring Analog Channel Functions” in Chapter 3 of this manual.)
3. **Open Spy Window** Select the Spy command from the Utilities menu. Select channel 0101 (instrument 01, channel 01) from the Channel list. Click OK to open the Spy window.
4. **Verify Accuracy** Configure the Decade Resistance Source for the output values below and verify the Spy window measurement is between the minimum and maximum values. Change the channel 1 range as required (see Step 2).

Resistance Range*	Decade Resistor	Minimum Reading	Maximum Reading
30 kΩ	Short Circuit (Zero)	700Ω	1 kΩ
30 kΩ	29 kΩ	29.681 kΩ	30.019 kΩ
300 kΩ	290 kΩ	289.07 kΩ	292.63 kΩ
3 MΩ	2.9 MΩ	2.8607 MΩ	2.9410 MΩ
* The resistance accuracy in this table makes allowance for up to 0.1 Ohm of lead wire resistance plus 0.01% decade resistance tolerance. You must add any additional lead wire resistance present in your setup to the resistance values given in this table.			

Resistance Range*	5700A	Minimum Reading	Maximum Reading
30 kΩ	Short Circuit (Zero)	700Ω	1 kΩ
30 kΩ	19 kΩ	19.686 kΩ	20.014 kΩ
300 kΩ	190 kΩ	189.60 kΩ	192.10 kΩ
3 MΩ	1.9 MΩ	1.8740 MΩ	1.9277 MΩ
* The resistance accuracy in this table makes allowance for up to 0.1 Ohm of lead wire resistance. You must add any additional lead wire resistance present in your setup to the resistance values given in this table.			

5. Close Spy Window.

4-Wire Resistance Accuracy Test (2640A)

6-19.

Ensure that the Accuracy Tests (above) have been completed before performing this test on the 2640A.

1. **Connect the Resistance Source to Channels 1 and 11** Remove the Universal Input Module from the instrument and connect a cable from the Decade Resistance Source to the Universal Input Module terminals for channel 1 (Sense) and channel 11 (Source) as shown in Figure 6-4. Reinstall the Universal Input Module. You may also use the 5700A resistance calibration output instead of the Decade Resistance Source. Tables are provided for both connections. Refer to Figure 6-5 for the 5700A 4-wire connections.
2. **Configure Channel 1 for Resistance** In NetDAQ Logger, configure channel 1 for Ohms-4W, 300 range. (See "Configuring Analog Channel Functions" in Chapter 3 of this manual.)
3. **Open Spy Window** Select the Spy command from the Utilities menu. Select analog channel 01. Click OK to open the Spy window.

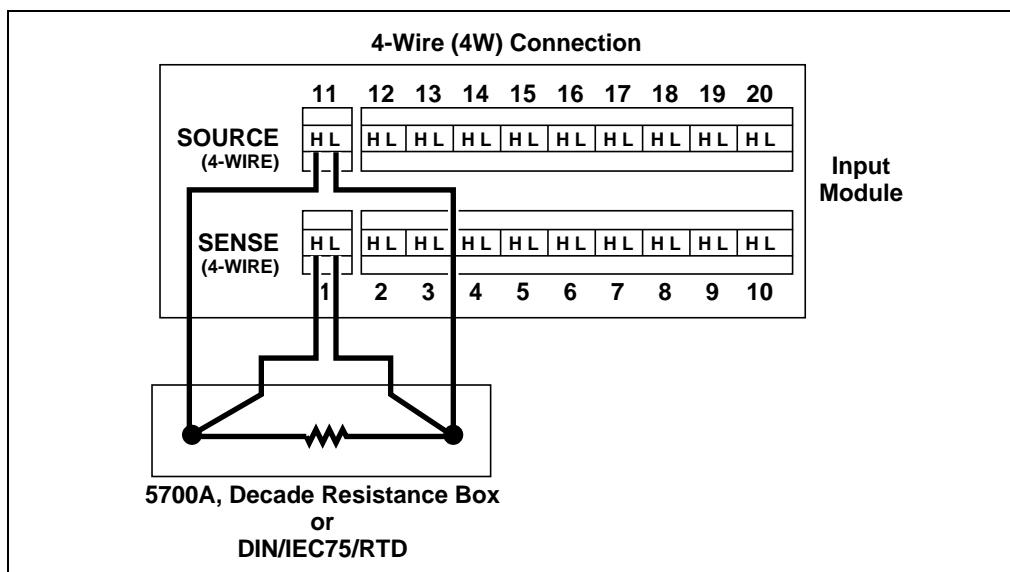

Figure 6-4. 4-Wire Connections to the Universal Input Module (Resistor)

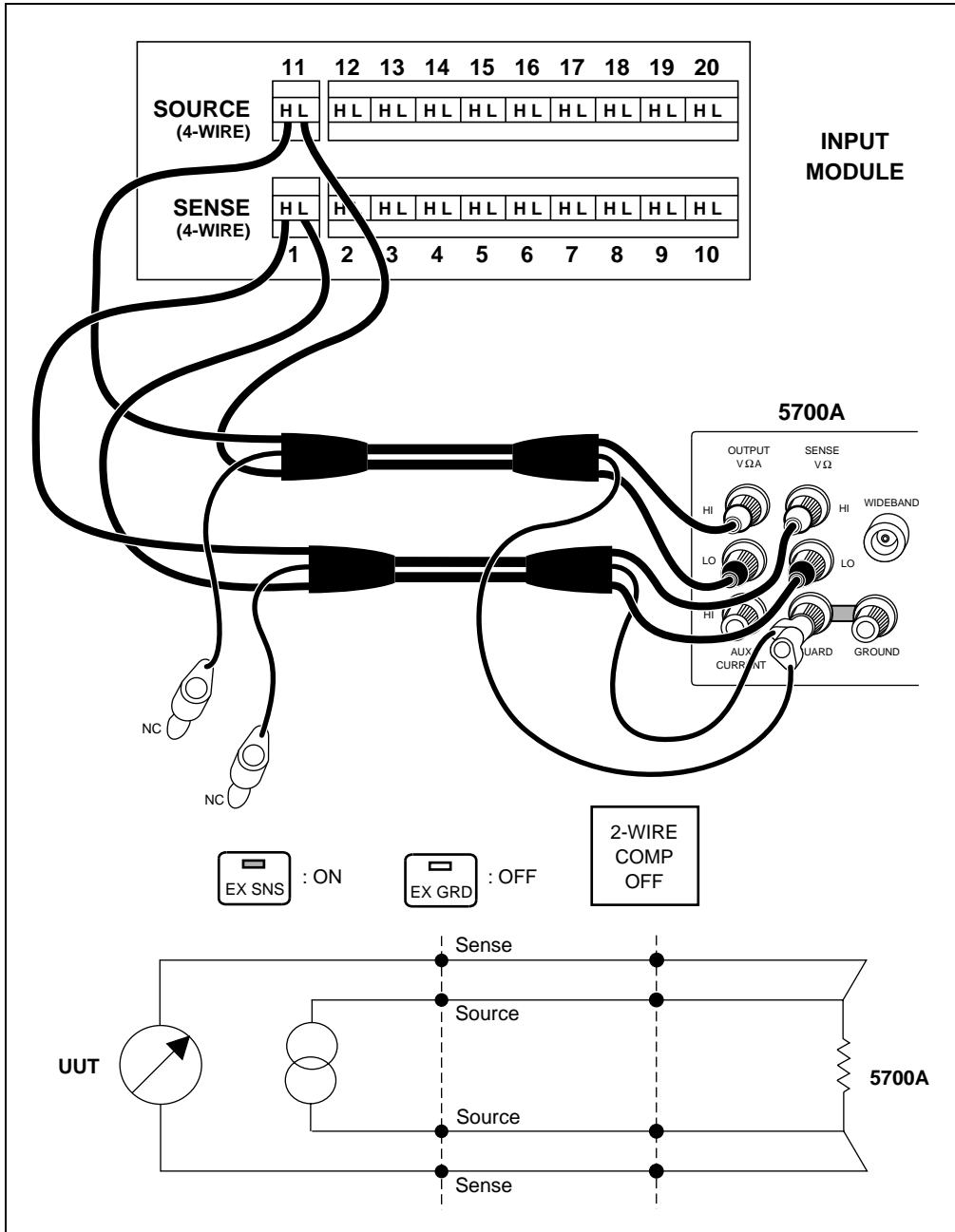

Figure 6-5. 4-Wire Connections to the Universal Input Module (5700A)

4. **Verify Accuracy** Configure the Decade Resistance Source for the output values below and verify the Spy window measurement is between the minimum and maximum values. Change the channel 1 range as required (see Step 2).

Resistance Range	Decade Resistor	Minimum Reading	Maximum Reading
300Ω	Short Circuit (Zero)	0Ω	0.05Ω
300Ω	290Ω	289.861Ω	290.139Ω
3 kΩ	Short Circuit (Zero)	0Ω	0.5Ω
3 kΩ	2.9 kΩ	2.89849 kΩ	2.90137 kΩ
30 kΩ	29 kΩ	28.9834 kΩ	29.0166 kΩ
300 kΩ	290 kΩ	289.621 kΩ	290.379 kΩ
3 MΩ	2.9 MΩ	2.89146 MΩ	2.90854 MΩ

The resistance accuracy in this table makes allowance for up to 0.01% decade resistance tolerance.

Resistance Range	5700A	Minimum Reading	Maximum Reading
300Ω	Short Circuit (Zero)	0Ω	0.030Ω
300Ω	190Ω	189.912Ω	190.088Ω
3 kΩ	Short Circuit (Zero)	0Ω	0.30Ω
3 kΩ	1.9 kΩ	1.89912 kΩ	1.90088 kΩ
30 kΩ	19 kΩ	18.9893 kΩ	19.0107 kΩ
300 kΩ	190 kΩ	189.750 kΩ	190.250 kΩ
3 MΩ	1.9 MΩ	1.89425 MΩ	1.90575 MΩ

5. **Close Spy Window.**

4-Wire Resistance Accuracy Test (2645A)

6-20.

Ensure that the Accuracy Tests (above) have been completed before performing this test on the 2645A.

1. **Connect the Resistance Source to Channels 1 and 11** Remove the Universal Input Module from the instrument and connect a cable from the Decade Resistance Source to the Universal Input Module terminals for channel 1 (Sense) and channel 11 (Source) as shown in Figure 6-4. Reinstall the Universal Input Module. You may also use the 5700A resistance calibration output instead of the Decade Resistance Source. Tables are provided for both connections. Refer to Figure 6-5 for the 5700A 4-wire connections.
2. **Configure Channel 1 for Resistance** In NetDAQ Logger, configure channel 1 for Ohms-4W, 300 range. (See "Configuring Analog Channel Functions" in Chapter 3 of this manual.)
3. **Open Spy Window** Select the Spy command from the Utilities menu. Select analog channel 01. Click OK to open the Spy window.
4. **Verify Accuracy** Configure the Decade Resistance Source for the output values below and verify the Spy window measurement is between the minimum and maximum values. Change the channel 1 range as required (see Step 2).

Resistance Range	Decade Resistor	Minimum Reading	Maximum Reading
300Ω	Short Circuit (Zero)	0Ω	0.1Ω
300Ω	290Ω	289.81Ω	290.19Ω
3 kΩ	Short Circuit (Zero)	0Ω	1.0Ω
3 kΩ	2.9 kΩ	2.8981 kΩ	2.9019 kΩ
30 κΩ	29 kΩ	28.981 kΩ	29.019 kΩ
300 κΩ	290 kΩ	288.37 kΩ	291.63 kΩ
3 MΩ	2.9 MΩ	2.8600 MΩ	2.9400 MΩ

The resistance accuracy in this table makes allowance for up to 0.01% decade resistance tolerance.

Resistance Range	5700A	Minimum Reading	Maximum Reading
300Ω	Short Circuit (Zero)	0Ω	0.1Ω
300Ω	190Ω	189.86Ω	190.14Ω
3 kΩ	Short Circuit (Zero)	0Ω	1.0Ω
3 kΩ	1.9 kΩ	1.8986 kΩ	1.9014 kΩ
30 kΩ	19 kΩ	18.986 kΩ	19.014 kΩ
300 kΩ	190 kΩ	188.90 kΩ	191.10 kΩ
3 MΩ	1.9 MΩ	1.8733 MΩ	1.9267 MΩ

5. Close Spy Window.

RTD Temperature Accuracy Test (Resistance) (2640A)

6-21.

The following RTD accuracy test applies to the 2640A and uses the 4-wire connection (see Figure 6-4).

1. **Connect the Decade Resistance Source to Channels 1 and 11** Remove the Universal Input Module from the instrument and connect a cable from the Decade Resistance Source to the Universal Input Module terminals for channel 1 (Sense) and channel 11 (Source) as shown in Figure 6-4.
2. **Configure Channel 1 for RTD-4W** In NetDAQ Logger, configure channel 1 for RTD-4W, Fixed-385 range, with RTD R0 set to 100 Ohms. (See "Configuring Analog Channel Functions" in Chapter 3 of this manual.)
3. **Open Spy Window** Select the Spy command from the Utilities menu. Select analog channel 01. Click OK to open the Spy window.
4. **Verify Accuracy** Configure the Decade Resistance Source for the output values below and verify the Spy window simulated temperature measurement is between the minimum and maximum values.

Decade Resistance Source Value	Simulated Temperature (°C)	Minimum Reading	Maximum Reading
100	0°C	-0.13°C	+0.13°C
200	266.34°C	266.13°C	266.55°C
300	557.70°C	557.40°C	558.00°C

5. Close Spy Window.

RTD Temperature Accuracy Test (Resistance) (2645A)

6-22.

The following RTD accuracy test applies to the 2645A and uses the 4-wire connection (see Figure 6-4).

1. **Connect the Decade Resistance Source to Channels 1 and 11** Remove the Universal Input Module from the instrument and connect a cable from the Decade Resistance Source to the Universal Input Module terminals for channel 1 (Sense) and channel 11 (Source) as shown in Figure 6-4.
2. **Configure Channel 1 for RTD-4W** In NetDAQ Logger, configure channel 1 for RTD-4W, Fixed-385 range, with RTD R0 set to 100 Ohms. (See "Configuring Analog Channel Functions" in Chapter 3 of this manual.)
3. **Open Spy Window** Select the Spy command from the Utilities menu. Select analog channel 01. Click OK to open the Spy window.
4. **Verify Accuracy** Configure the Decade Resistance Source for the output values below and verify the Spy window simulated temperature measurement is between the minimum and maximum values.

Decade Resistance Source Value	Simulated Temperature (°C)	Minimum Reading	Maximum Reading
100	0°C	-0.31°C	+0.31°C
200	266.34°C	265.94°C	266.74°C
300	557.70°C	556.07°C	558.33°C

5. **Close Spy Window.**

RTD Temperature Accuracy Test (DIN/IEC 751 RTD)

6-23.

The following RTD accuracy test applies to both the 2640A and 2645A, and uses the 4-wire connection (see Figure 6-4).

1. **Connect the RTD Source to Channels 1 and 11** Remove the Universal Input Module from the instrument and connect the RTD to the Universal Input Module terminals for channel 1 (Sense) and channel 11 (Source) as shown in Figure 6-4.
2. **Configure Channel 1 for RTD-4W** In NetDAQ Logger, configure channel 1 for RTD-4W, Fixed-385 range, with RTD R0 set to 100 Ohms (assuming the reference R0=100; enter the correct value for R0). (See "Configuring Analog Channel Functions" in Chapter 3 of this manual.)
3. **Open Spy Window** Select the Spy command from the Utilities menu. Select analog channel 01. Click OK to open the Spy window.

4. **Verify Accuracy** Insert the RTD and a mercury thermometer in a room-temperature bath. Allow 20 minutes for thermal stabilization. The value displayed on the mercury thermometer should equal the value in the Spy Window $\pm 0.25^{\circ}\text{C}$ (2640A) or $\pm 0.80^{\circ}\text{C}$ (2645A) plus sensor inaccuracies.
5. **Close Spy Window.**

Digital Input/Output Tests

6-24.

The Digital Input/Output Tests check the eight Digital I/O lines on the DIGITAL I/O connector for output and input functions.

Digital I/O Output Test

6-25.

This test checks the Digital I/O lines when used as outputs.

1. **Open Spy Window** Select the Spy command from the Utilities menu. Select 01DIO. Click OK to open the Spy window.
2. **Verify Digital I/O Output for all Unset Lines** The Spy window summarizes the 8 DIO binary lines as a decimal equivalent, i.e., 255 for the present condition of all lines unset (11111111).
3. **Measure DIO Lines** Using a digital multimeter, measure the output of each DIO line, referenced to the GND line, for a voltage greater than +3.8V dc.
4. **Close Spy Window.**
5. **Configure Channels 1 to 8 for Volts DC** In NetDAQ Logger, configure channels 1 to 8 for Volts dc, 3V range. (See "Configuring Analog Channel Functions" in Chapter 3 of this manual.)
6. **Configure Channels 1 to 8 for Alarms** In NetDAQ Logger, configure each channel 1 to 8 for an Alarm 1 with Alarm Sense=LO, Alarm Value=1 and Digital Outputs assigned as below. (See "Configuring Alarms" in Chapter 3 of this manual.)
 - Channel 1 - Digital Output DO0
 - Channel 2 - Digital Output DO1
 - Channel 3 - Digital Output DO2
 - Channel 4 - Digital Output DO3
 - Channel 5 - Digital Output DO4
 - Channel 6 - Digital Output DO5
 - Channel 7 - Digital Output DO6
 - Channel 8 - Digital Output DO7
7. **Verify Channels and Alarm Configuration** After Steps 5 and 6 are completed, the portion of the Main Window for channels and alarms configuration will appear as shown below.

Chan	Function	Range	Alarm 1	Alarm 2	Trg	Mx+B	Units	Label
0101	VDC	3V	LO->DO0	OFF	NA	OFF	VDC	Label
0102	VDC	3V	LO->DO1	OFF	NA	OFF	VDC	Label
0103	VDC	3V	LO->DO2	OFF	NA	OFF	VDC	Label
0104	VDC	3V	LO->DO3	OFF	NA	OFF	VDC	Label
0105	VDC	3V	LO->DO4	OFF	NA	OFF	VDC	Label
0106	VDC	3V	LO->DO5	OFF	NA	OFF	VDC	Label
0107	VDC	3V	LO->DO6	OFF	NA	OFF	VDC	Label
0108	VDC	3V	LO->DO7	OFF	NA	OFF	VDC	Label

8. **Short Channel Inputs** Remove the Universal Input Module from the instrument and apply a short to channels 1 through 8. Reinstall the Universal Input Module.
9. **Start Instrument Scanning** Select Logging | Start Instrument to start the instrument scanning. The instrument must be scanning to set the DIO lines.
10. **Open Spy Window** Select the Spy command from the Utilities menu. Select 01DIO. Click OK to open the Spy window.
11. **Verify Digital I/O Output for all Set Lines** The Spy window summarizes the 8 DIO binary lines as a decimal equivalent, i.e., 0 for the present condition of all lines set (00000000).
12. **Measure DIO Lines** Using a digital multimeter, measure the output of each DIO line, referenced to the GND line, for a voltage less than +0.8V dc.
13. **Close Spy Window.**
14. **Stop Instrument Scanning** Select Logging | Stop Instrument to stop instrument scanning.

Digital Input Test

6-26.

This test checks the Digital I/O lines when used as inputs.

1. **Connect Test Leads to DIGITAL I/O Connector** Remove the 10-position DIGITAL I/O connector from the instrument rear panel. Connect a test lead to each DIO line 0 to 7, plus a test lead to the GND line. Also connect a test lead to the Σ (Totalizer) output. Reinstall the connector.
2. **Open Spy Window** Select the Spy command from the Utilities menu. Select 01DIO. Click OK to open the Spy window.

3. **Verify Digital I/O Input for all Set Lines** In sequence, individually ground each DIO line to the GND line using the DIO wires connected in Step 1. Note the change in the DIO status reported in the Spy window as follows:

None grounded Reported DIO Status = 255
DIO0 grounded Reported DIO Status = 254
DIO1 grounded Reported DIO Status = 253
DIO2 grounded Reported DIO Status = 251
DIO3 grounded Reported DIO Status = 247
DIO4 grounded Reported DIO Status = 239
DIO5 grounded Reported DIO Status = 223
DIO6 grounded Reported DIO Status = 191
DIO7 grounded Reported DIO Status = 127

4. **Close Spy Window.**

Totalizer Tests

6-27.

The Totalizer Tests check the Totalizer feature for counting and sensitivity.

Totalizer Count Test

6-28.

This test checks the ability of the Totalizer feature to count.

1. **Enable Totalizer Debounce** In NetDAQ Logger, select Setup | Instrument Configuration to open the Instrument Configuration dialog box. Check Totalizer Debounce if it is not already checked and click OK.
2. **Open Spy Window** Select the Spy command from the Utilities menu. Select 01TOTAL. Click OK to open the Spy window.
3. **Increase Totalizer Count** Connect the Σ (Totalizer) test lead to the GND line and disconnect again. Each time this is done, the Totalizer count should increase one.
4. **Verify Totalizer Count** The Spy window displays the new Totalizer count which is equal to the number of contacts between totalizer and ground.
5. **Close Spy Window.**

Totalizer Sensitivity Test

6-29.

This test checks the ability of the Totalizer feature to count voltage transition at a particular sensitivity level.

1. **Disable Totalizer Debounce** In NetDAQ Logger, select Setup | Instrument Configuration to open the Instrument Configuration dialog box. Uncheck Totalizer Debounce if it is currently checked and click OK.

2. **Connect Test Leads** At the DIGITAL I/O connector, connect the Σ (Totalizer) test lead and GND test lead to a signal generator's output terminals. Adjust the signal generator for an output of 1.5V rms sine wave at 10 Hz.
3. **Open Spy Window** Select the Spy command from the Utilities menu. Select 01TOTAL. Click OK to open the Spy window.
4. **Verify Totalizer Count** The Spy window displays the Totalizer count. Verify the totalizer count is advancing at approximately 10 counts per spy window update (nominal 1 second intervals).
5. **Close Spy Window.**

Master Alarm Output Test

6-30.

This test checks the Master Alarm output for a logic low when a channel is in alarm.

1. **Connect Test Leads to ALARM/TRIGGER I/O Connector** Remove the 8-position ALARM/TRIGGER I/O connector from the instrument rear panel. Connect a test lead to each line, MA (Master Alarm), TO (Trigger Output), TI (Trigger Input), plus a test lead to the GND line. (See Figure 2-6.) Reinstall the connector.
2. **Measure MA Line** Using a digital multimeter, measure the output of the unset MA test lead, referenced to the GND test lead, for a voltage greater than +3.8V dc.
3. **Verify Configuration Channel 1 for Volts DC** In NetDAQ Logger, verify channel 1 is configured for Volts dc, 3V range. (See "Configuring Analog Channel Functions" in Chapter 3 of this manual.)
4. **Verify Configuration Channel 1 for Alarms** In NetDAQ Logger, verify channel 1 is configured for an Alarm 1 with Alarm Sense=LO, Alarm Value=1 and Digital Output=DO0. (See "Configuring Alarms" in Chapter 3 of this manual.)
5. **Start Instrument Scanning** Click the Start Instrument button on the Button Bar to start instrument scanning. Scanning is initiated to enable the Master Alarm output.
6. **Measure MA Line** Using a digital multimeter, measure the output of the set MA test lead, referenced to the GND test lead, for a voltage less than +0.8V dc.
7. **Stop Scanning** Select Logging | Stop Instrument to stop instrument scanning.

Trigger Input Test

6-31.

This test checks the ability of the Trigger Input line to trigger measurement scanning.

1. **Configure Trigger Input** In NetDAQ Logger, configure the scan parameters for External Trigger with an Interval 2 of 1 second. Be sure Interval Trigger and Alarm Trigger are not enabled. (See “Trigger Input” in Chapter 3 of this manual.)
2. **Verify Configuration Channel 1 for Volts DC** In NetDAQ Logger, verify channel 1 is configured for Volts dc, 3V range. (See "Configuring Analog Channel Functions" in Chapter 3 of this manual.)
3. **Start Instrument Scanning** Click the Start Instrument button on the Button Bar to enable instrument scanning, although no measurement scanning takes place because the external Trigger Input is not set.
4. **Open Logging Status Window** Select the Show Logging Status command from the Options menu to display the Logging Status window.
5. **Verify Logging Status** Note in the Logging Status window that the Retrieved Scans count is zero and not incrementing.
6. **Set Trigger Input** While monitoring the Logging Status window, connect the TI (Trigger Input) test lead to the GND test lead. Note in the Logging Status window, the Retrieved Scans count increments at 1-second intervals. Disconnect the TI and GND test lead connection.
7. **Stop Scanning** Click the Stop Instrument button on the Button Bar to stop instrument scanning.

Trigger Output Test

6-32.

This test checks the Trigger Output (125 μ s logic low) that occurs each time the instrument scans.

1. **Configure Interval Trigger** In NetDAQ Logger, configure the scan parameters for Interval Trigger with an Interval 1 of 1 second. (See “The Instrument Configuration Dialog Box” in Chapter 3 of this manual.)
2. **Verify Configuration Channel 1 for Volts DC** In NetDAQ Logger, verify channel 1 is configured for Volts dc, 3V range. (See "Configuring Analog Channel Functions" in Chapter 3 of this manual.)
3. **Measure Unset Trigger Output Line** Using a digital multimeter, measure the output of the unset TO test lead, referenced to the GND test lead, for a voltage greater than +3.8V dc.

4. **Verify Trigger Output is Enabled** In NetDAQ Logger, select Setup | Instrument Config. In the Instrument Configuration dialog box, verify the Trigger Out box is checked. Click OK to return to the Main Window. (See "The Instrument Configuration Dialog Box" in Chapter 3 of this manual.)
5. **Connect Trigger Output** Connect the TO test lead on the ALARM/TRIGGER IO connector to the Σ (Totalizer) test lead on the DIGITAL I/O connector. This allows each Trigger Output pulse to be counted by the Totalizer.
6. **Start Instrument Scanning** Click the Start Instrument button on the Button Bar to enable instrument scanning.
7. **Open Spy Window** Select the Spy command from the Utilities menu. Select 01TOTAL. Click OK to open the Spy window.
8. **Verify Totalizer Count** The Spy window displays the Totalizer count. Note the Totalizer is incrementing at 1-second intervals as it counts the Trigger Output pulse at the start of each scan.
9. **Close Spy Window.**
10. **Stop Scanning** Click the Stop Instrument button on the Button Bar to stop instrument scanning.

Calibration

6-33.

Note

Refer to the Service Manual (PN 942615) for calibration procedures. The instrument must be stabilized in an environment with an ambient temperature of 22°C to 24°C and a relative humidity of less than 70%, and must have been powered at least 30 minutes prior to calibration.

The instrument features closed-case calibration, that is, calibration that is completed over the RS-232 interface. Using known reference sources, closed-case calibration has many advantages. There are no parts to disassemble, no mechanical adjustments to make, and the instrument can be calibrated by an automated instrumentation system.

The instrument should normally be calibrated on a regular cycle, typically every 90 days to 1 year. The chosen calibration cycle depends on the accuracy specification you wish to maintain. The instrument should also be calibrated if it fails the performance test or has undergone repair.

Note

Do not press CAL ENABLE unless you have a copy of the Service Manual and intend to calibrate the instrument. If you have activated calibration and wish to exit, press CAL ENABLE until the CAL annunciator is removed from the display (or turn the power off).

Adding Calibration to the Utilities Menu**6-34.**

To add calibration to the Utilities menu, complete the following procedure:

1. Exit NetDAQ Logger.
2. Add /c switch to the NetDAQ Logger command line. If you do not know how to add the switch, see “Starting NetDAQ Logger with a Setup File” and “NetDAQ Logger Command Line” in Chapter 3 of this manual.

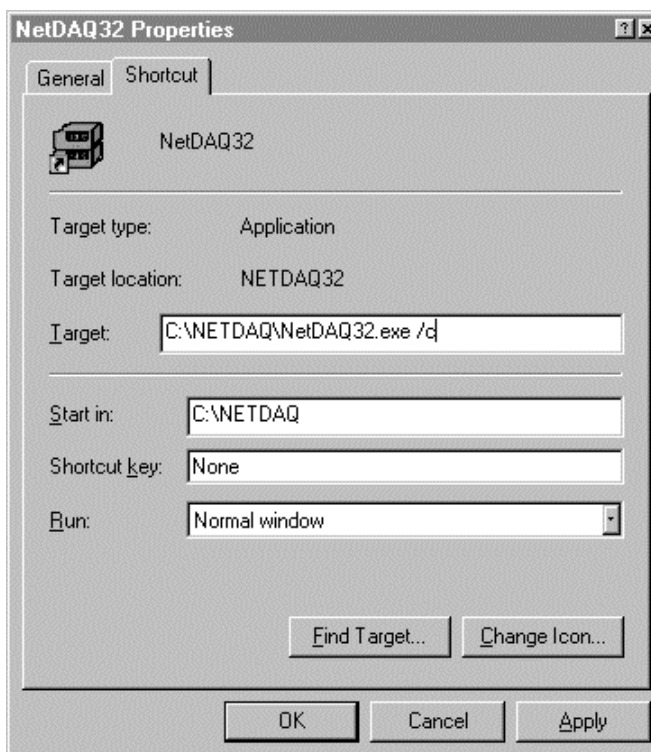

ds070.bmp

3. Start NetDAQ Logger and the Instrument Calibration command is now listed in the Utilities menu.

Instrument Calibration Dialog Box**6-35.**

The Instrument Calibration dialog box (below) sets up the RS-232 port for calibrating the instrument and provides calibration function selection. See the Service Manual (PN 942615) for the calibration procedure.

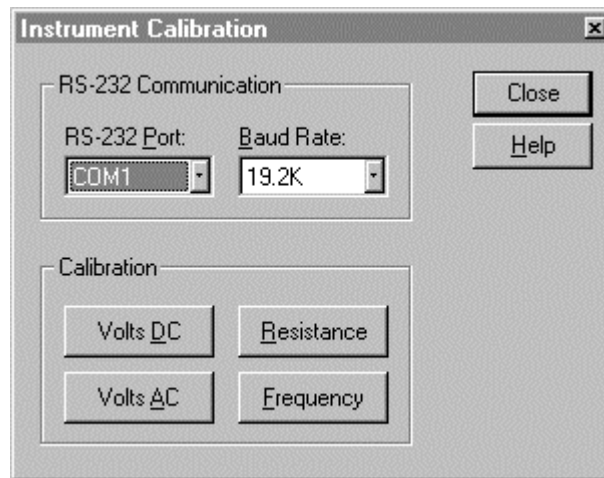

ds306s.bmp

RS-232 Port Click the scroll arrow to list the RS-232 port choices: COM1 to COM4. Default is COM1. This is the Host Computer port connected to the instrument.

Baud Rate Click the scroll arrow to list the baud rate choices: 4800, 9600, 19.2K, and 38.4K. Default is 19.2K this rate must match the rate selected as the instrument front panel.

Volts dc Click to perform volts dc calibration.

Volts ac Click to perform volts ac calibration.

Resistance Click to perform resistance calibration.

Frequency Click to perform frequency calibration.

Calibration Steps Dialog Box**6-36.**

The Calibration Steps dialog box (below) performs the calibration steps for volts dc, volts ac, resistance, or frequency. The calibration procedure is provided in the Service Manual (PN 942615).

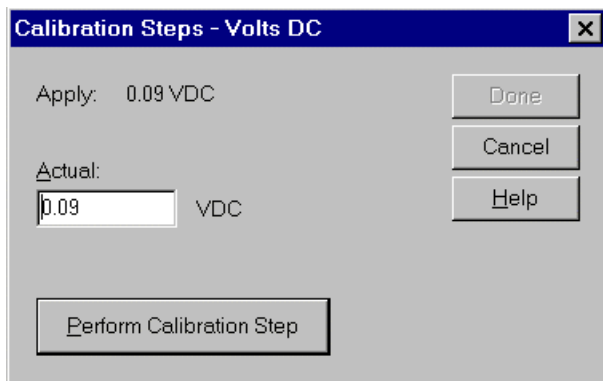

ds308s.bmp

Apply Displays the suggested value to apply to the instrument from the calibrator.

Actual Enter the actual value applied to the instrument from the calibrator. Use a value as close as possible to the suggested value for best calibration results.

Perform Calibration Step Apply the calibrator output to the instrument and then click this button to perform the calibration.



Variations in the Display

6-37.

Under normal operation, the display presents various combinations of brightly and dimly lit annunciators and digits. However, you may encounter other, random irregularities across different areas of the display under the following circumstances:

- After prolonged periods of displaying the same information.
- The display has not been used for a prolonged period

This phenomenon can be cleared by activating the entire display and leaving it on overnight (or at least for several hours). Use the following procedure to keep the display fully lit:

1. Turn the instrument power off.
2. Press the front panel  key and then apply power. Continue to hold the  key until the instrument beeps. The entire front panel display comes on and stays on.
3. When you wish to return the display to normal, press any front panel key.

Service

6-38.

If the instrument fails to operate, check that operating instructions presented earlier in this manual are being followed. If the problem cannot be remedied, send the instrument, postage paid, to the nearest Fluke Service Center. A list of Service

Centers is provided in Appendix K of this manual. Be sure to pack the instrument securely; use the original container if available. Include a description of the problem. Fluke assumes no responsibility for damage in transit.

For application or operation assistance or information on Fluke products, telephone:

1-800-44-FLUKE (1-800-443-5853) in USA and Canada
31 40 2 678200 in Europe
1-206-356-5500 from other countries

For written assistance or information, contact:

Fluke Corporation
Post Office Box 9090
Everett, WA
98206-9090
USA

Fluke Europe B.V.
Post Office Box 1186
5602 B.D
Eindhoven
The Netherlands

Fluke offers a 1-year warranty for the 264XA-801 (Ethernet plug-in card) and 264XA-802 (Ethernet Parallel-to-LAN adapter), and 264XA-803 (PCMCIA Adapter) options. Defective units may be returned to either Fluke or to the option manufacturer for repair or replacement. The original equipment manufacturer may offer warranties beyond the warranty supplied by Fluke.

Replacement Parts

6-39.

Replacement parts are listed in Table 6-3. To order replacement parts in the USA, call 1-800-526-4731. To order parts from outside the USA, contact the nearest Fluke Service Center. (See Appendix K, "Fluke Service Centers."). Other instrument models, options and accessories are listed in Table 1-1.

Table 6-3. Replacement Parts

Part Number	Description
343723	Power Cable
851712	RS-232 Cable (for calibration) 9-pin socket to 25-pin socket
875877	ALARM/TRIGGER I/O Connector
875880	DIGITAL I/O Connector
926126	Replacement Fuse 15/100A, 250V, Time Delay (lot of 5 pieces)
926134	Replacement Fuse 15/100A, 250V, Time Delay (lot of 25 pieces)
942615	NetDAQ Service Manual
942813	BNC "Y" Connector
942834	BNC 50-Ohm Termination without Ground Wire for 10Base2
943600	4-meter 10Base2 Coaxial Ethernet Cable
944538	BNC 50-Ohm Termination with Ground Wire for 10Base2
944629	Replacement Fuse 15/100A, 250V, Time Delay

Appendices

Appendix	Title	Page
A	Specifications	A-1
B	Noise, Shielding, and Crosstalk Considerations	B-1
C	True-RMS Measurements	C-1
D	RTD Linearization.....	D-1
E	Computed Channel Equations	E-1
F	Data File Format.....	F-1
G	Dynamic Data Exchange (DDE)	G-1
H	Ethernet Cabling.....	H-1
I	Network Considerations	I-1
J	Error Messages & Exception Condition.....	J-1
K	Fluke Service Centers.....	K-1

Appendix A Specifications

Introduction

A-1.

Specifications are divided into three sections. The first section contains the combined specifications that apply equally to both the 2640A and 2645A instruments. The second section contains specifications that apply only to the 2640A instrument. The third section contains specifications that apply only to the 2645A instrument.

2640A/2645A Combined Specifications

A-2.

The following specifications apply equally to both the 2640A and 2645A instruments. The topics include:

- 2640A/2645A General Specifications
- 2640A/2645A Environmental Specifications
- 2640A/2645A Digital I/O and Totalizer Interface

2640A/2645A General Specifications

A-3.

Table A-1 provides the general specifications for the 2640A and 2645A instruments.

Table A-1. 2640A/2645A General Specifications

Specification	Characteristic
Channel Capacity	20
I/O Lines Total	12
Size	9.3 cm high, 21.6 cm wide, 36.2 cm deep (3.67 in high, 8.5 in wide, 14.28 in deep)
Weight	Net, 4 kg (8.8 lb.) Shipping, 6.0 kg (13.2 lb.)
Power	107 to 264V ac (no switching required), 50 and 60 Hz, 15VA maximum 9V dc to 16V dc, 6W maximum If both sources are applied simultaneously, ac voltage is used if it exceeds approximately 8 times the dc voltage. Automatic switchover occurs between ac and dc without interruption.
Safety Standards	Both instruments comply with: IEC 1010-1 UL 1244 CSA Bulletin 556B. ANSI/ISA-S82.01-1994 CSA C22.2 No. 1010.1-92
EMC Standards	When shielded cables are used, both instruments comply with: Vfg. 243/1991 FCC-15B, at the Class B level EN 50081-1 EN 50082-1
Serial Interface (RS-232C)	Connector: 9 pin male (DI-9P) Signals: TX, RX, DTR, RTS, GND Modem Control: full duplex Baud rates: 4800, 9600, 19200, 38400 Data format: 8 data bits, no parity bit, one stop bit Flow control: XON/XOFF Echo: Off
Common Mode Voltage	2640A 150V (300V on channels 1 and 11) 2645A 50V dc or 30V ac rms.

Table A-1. 2640A/2645A General Specifications (cont)

Specification	Characteristic
Maximum Measurement Speed (Scanning Rates)	2640A Slow - 6 readings per second Medium - 45 readings per second (60 Hz) Fast - 143 readings per second (20 configured channels) 2645A Slow - 54 readings per second (60 Hz) Medium - 200 readings per second Fast - 1000 readings per second (20 configured channels) Fast single Channel - 400 readings per second
Accuracy of Medium Scanning Rate	= (Fast Accuracy + Slow Accuracy)/2
Additional error if "Automatic drift correction" is turned off.	If the instrument was fully warmed-up at the time drift correction was disabled, i.e. turned-on at least 1 hour earlier; 1/10 of the 90 day specification per °C change in ambient temperature from the temperature when drift correction was disabled. If the instrument was NOT fully warmed-up at the time drift correction was disabled; Add an error equal to the 90 day specification for instrument warm-up + 1/10 of the 90 day specification per °C change in ambient temperature from the temperature when drift correction was disabled.

2640A/2645A Environmental Specifications

A-4.

Table A-2 provides a summary of the environmental specifications for the 2640A/2645A.

Table A-2. 2640A/2645A Environmental Specifications

Specification	Characteristic
Warm-up Time	1 hour to rated specifications -or- 15 minutes if relative humidity (non-condensing) is 50% or less.
Operating Temperature	-20°C to 60°C (-4°F to 140°F)
Storage Temperature	-40°C to +70°C (-40°F to +158°F)
Relative Humidity	90% maximum for -10°C to 28°C (14°F to 82.4°F) 75% maximum for 28°C to 35°C (82.4°F to 95°F) 50% maximum for 35°C to 60°C (95°F to 140°F) (3 M Ω range, reduce humidity rating by 25% for 1 hour warm-up. 3 M Ω range meets full humidity ratings with 2 hour warm-up.)
Altitude	Operating: 2,000m (6,561 ft) maximum Non-operating: 12,200m (40,000 ft) maximum
Vibration	0.7g at 15 Hz 1.3g at 25 Hz 3g at 55 Hz
Shock	30g half sine per Mil-T-28800E Bench handling per Mil-T-28800E

2640A/2645A Input/Output Capabilities**A-5.**

The following specifications include the input/output functions, including the Digital I/O, Trigger Out, Trigger In, and Master Alarm output.

Digital I/O**A-6.**

Table A-3 provides a summary of the Digital I/O specifications for the 8 Digital I/O lines (0 to 7). Digital I/O is located on the DIGITAL I/O connector, terminals 0 to 7, and GND.

Table A-3. 2640A/2645A DIGITAL I/O Specification

Specification	Characteristic
Maximum Input Voltage	30V
Minimum Input Voltage	-4V
Isolation	None (dc coupled)
Threshold	1.4V
Hysteresis	500 mV

Table A-3. 2640A/2645A DIGITAL I/O Specification (cont)

Specification	Characteristic
Output Voltage - TTL Logical Zero	0.8V maximum for an I out of -1.0 mA (1 LSTTL load)
Output Voltage - TTL Logical One	3.8V minimum for an I out of 0.05 mA (1 LSTTL load)
Output Voltage - Non-TTL Load Zero	1.8V maximum for an I out of -20 mA
Output Voltage - Non-TTL Load One	3.25V maximum for an I out of -50 mA

Trigger In

A-7.

Table A-4 provides a summary of the Trigger In specifications. The Trigger In input is located on the ALARM/TRIGGER I/O connector, terminals TI and GND.

Table A-4. 2640A/2645A Trigger In (TI) Specification

Specification	Characteristic
Logical High - Trigger not set	Minimum: 2.0V Maximum: 7.0V
Logical Low - Trigger set	Minimum: -0.6V Maximum: +0.8V
Compatibility	TTL or Contact Closure
Isolation	None (dc coupled)
Minimum Pulse Width	5 μ s
Maximum Frequency	Nominal 400 Hz
Repeatability	3 ms

Trigger Out

A-8.

Table A-5 provides a summary of the Trigger Out specifications. The Trigger Out output is located on the ALARM/TRIGGER I/O connector, terminals TO and GND.

Table A-5. 2640A/2645A Trigger Out (TO) Specification

Specification	Characteristic
TTL Logical Zero - Trigger Out Set	0.8V maximum for an lout of -1.0 mA (1 LSTTL load)
TTL Logical One - Trigger Out Not Set	3.8V minimum for an lout of 0.05 mA (1 LSTTL load)
Non-TTL Logical Zero - Trigger Out Set	1.8V maximum for an lout of -20 mA
Non-TTL Logical One - Trigger Out Not Set	3.25V maximum for an lout of -50 mA
Pulse Duration (Logic Low)	125 μ s
Isolation	None

Master Alarm

A-9.

Table A-6 provides a summary of the Master Alarm specifications. The Master Alarm output is located on the ALARM/TRIGGER I/O connector, terminals MA and GND.

Table A-6. 2640A/2645A Master Alarm (MA) Specification

Specification	Characteristic
TTL Logical Zero - Master Alarm Set	0.8V maximum for an lout of -1.0 mA (1 LSTTL load)
TTL Logical One - Master Alarm Not Set	3.8V minimum for an lout of 0.05 mA (1 LSTTL load)
Non-TTL Logical Zero - Master Alarm Set	1.8V maximum for an lout of -20 mA
Non-TTL Logical One - Master Alarm Not Set	3.25V maximum for an lout of -50 mA
Isolation	None

2640A/2645A Totalizer

A-10.

Table A-7 provides a summary of the Totalizer specifications. The Totalizer input is located on the DIGITAL I/O connector, terminals Σ and GND.

Table A-7. 2640A/2645A Totalizer Specification

Specification	Characteristic
Maximum Input Voltage	30V
Minimum Input Voltage	-4V
Minimum Peak Voltage	2V
Isolation	None (dc coupled)
Threshold	1.4V
Hysteresis	500 mV
Input Debouncing	None or 1.75 ms (selectable)
Maximum Transition Rate	5 kHz (Debounce disabled) 500 Hz (Debounce enabled)
Maximum Count	4,294,967,295

2640A/2645A Real-Time Clock and Calendar

A-11.

Table A-8 provides a summary of the battery powered real-time clock and calendar.

Table A-8. 2640A/2645A Real-Time Clock and Calendar

Specification	Characteristic
Accuracy	1 minute per month for 0°C to 50°C range
Battery Life	>15 unpowered instrument years for -20°C to 28°C (32°F to 82.4°F). >6 unpowered instrument years for -20°C to 50°C (32°F to 122°F). >4 unpowered instrument years for 50°C to 70°C (122°F to 158°F).

2640A Specifications

A-12.

This section includes specifications specific to the 2640A instrument by measurement function.

2640A DC Voltage Measurement Specifications**A-13.**

Tables A-9 to A-11 provide 2640A specifications for the dc voltage measurement function.

Table A-9. 2640A DC Voltage Measurement General Specifications

Specification	Characteristic
Input Impedance	100 M Ω in parallel with 150 pF maximum for ranges $\leq 3V$ 10 M Ω in parallel with 100 pF maximum for ranges $> 3V$
Normal Mode Rejection	50dB minimum at 50 Hz/60 Hz $\pm 0.1\%$, Slow Rate
Common Mode Rejection	120dB minimum at dc, 50 Hz/60 Hz $\pm 0.1\%$, 1 k Ω imbalance, Slow Rate 80dB minimum at dc, 50 Hz/60 Hz $\pm 0.1\%$, 1 k Ω imbalance, Medium and Fast Rates
Channel-to-Channel Crosstalk	120dB minimum Slow Rate (e.g., 30V dc on channel 1 may cause a 30 μV error on channel 2) 100dB minimum Medium and Fast Rates (e.g., 1V dc on channel 1 may cause a 10 μV error on channel 2)
Temperature Coefficient	Add 1/10th the 90-day specification per $^{\circ}C$ above 28 $^{\circ}C$ or below 18 $^{\circ}C$. (Generally, only the %input portion is affected.)
Accuracy at -20 $^{\circ}C$	Multiply the -10 $^{\circ}C$ to + 60 $^{\circ}C$ accuracy specification by 2. After 1 hour warm-up. For accuracy between -10 $^{\circ}C$ and -20 $^{\circ}C$, interpolate linearly.
Maximum Input Voltage	150V (300V for channels 1 and 11) to any input terminal.

Table A-10. 2640A DC Voltage Range and Resolution Specifications

Range	Resolution	
	Slow	Fast
90 mV	.3 μV	1 μV
300 mV	1 μV	3 μV
3V	10 μV	30 μV
30V	100 μV	300 μV
150V/300V	1 mV	3 mV

Note 300V range applies to channels 1 and 11 only.

Table A-11. 2640A DC Voltage Accuracy Specifications

Range	Accuracy, $3\sigma \pm$ (% input + V)					
	18°C to 28°C				-10°C to 60°C	
	90 Day		1 Year		1 Year	
	Slow	Fast	Slow	Fast	Slow	Fast
90 mV	.01%+7 μ V	.01%+17 μ V	.013%+8 μ V	.013%+18 μ V	.042%+18.2 μ V	.042%+44.2 μ V
300 mV	.01%+15 μ V	.01%+30 μ V	.013%+17 μ V	.013%+35 μ V	.042%+39 μ V	.042%+78 μ V
3V	.01%+.1 mV	.01%+.2 mV	.013%+.15 mV	.013%+.2 mV	.042%+.26 mV	.042%+.52mV
30V	.01%+1.5 mV	.02%+3 mV	.013%+1.7 mV	.026%+3.5 mV	.042%+3.9 mV	.084%+7.8mV
150/300V	.01%+15 mV	.04%+30 mV	.013%+17 mV	.052%+35 mV	.042%+39 mV	.168%+78 mV
Note 300V range applies to channels 1 and 11 only.						

2640A AC Voltage Measurement Specifications

A-14.

Tables A-12 to A-14 provide 2640A specifications for the ac voltage measurement function.

Table A-12. 2640A AC Voltage General Specifications

Specification	Characteristic
Input Impedance	1 M Ω in parallel with 100 pF
Maximum Crest Factor	3.0 Maximum 2.0 for rated accuracy
Crest Factor Error	For non-sinusoidal input signals with crest factors between 2 and 3 and pulse widths \geq 100 μ s, add 0.2% to the accuracy specifications.
Common Mode Rejection	80 dB minimum at dc, 50 Hz/60 Hz \pm 0.1%, 1 k Ω imbalance, Slow Rate

Table A-12. 2640A AC Voltage General Specifications (cont)

Specification	Characteristic
Maximum Input Voltage	The lesser voltage of: 300V ac rms from any terminal on channels 1 and 11 to earth. 150V ac rms from any terminal on channels 2 through 10, and 12 through 20 to earth. 300V ac rms from any terminal on channels 1 and 11 to any other terminal. 150V ac rms from any terminal on channels 2 through 10 and 12 through 20 to any other input terminal.
Maximum Volt-Hertz Product	2×10^6 Volt-Hertz product on any range, normal mode input. 1×10^6 Volt-Hertz product on any range, common mode input.
Temperature Coefficient	Linear interpolation between 2 applicable points for temperatures between 28°C and 60°C, or -10°C and 18°C, e.g., if the applicable specification at 28°C is 2% and the specification at 60°C is 3%, then the specification at 40°C is $(3\% - 2\%) \times (40 - 28) / (60 - 28) + 2\% = 2.375\%$.
Accuracy at -20°C	Multiply the -10°C to + 60°C accuracy specification by 2. After 1 hour warm-up. For accuracy between -10°C and -20°C, interpolate linearly.
DC Component Error	The presence of a dc voltage will cause an indeterminate error in the reading of the ac voltage on the input.

Table A-13. 2640A AC Voltage Range and Resolution Specifications

Range	Resolution		Minimum Input for Rate Accuracy
	Slow	Fast	
Full Scale	$\pm 30,000$	$\pm 3,000$	—
300 mV	10 μ V	100 μ V	20 mV
3V	100 μ V	1 mV	200 mV
30V	1 mV	10 mV	2V
150/300V	10 mV	100 mV	20V

Note 300V range applies to channels 1 and 11 only.

Table A-14. 2640A AC Voltage Accuracy Specifications

Range	Frequency	1 Year Accuracy \pm (%input + V)*			
		18°C to 28°C		-10°C to 60°C	
		Slow	Fast	Slow	Fast
300 mV	20 to 50 Hz	3%+.25 mV	6%+.5 mV	3.5%+.25 mV	7%+.5 mV
	50 to 150 Hz	0.4%+.25 mV	1%+.5 mV	0.5%+.25 mV	1.5%+.5 mV
	150 Hz to 10 kHz	0.3%+.25 mV	1%+.5 mV	0.4%+.25 mV	1.5%+.5 mV
	10 kHz to 20 kHz	0.4%+.25 mV	1%+.5 mV	0.7%+.25 mV	1.5%+.5 mV
	20 kHz to 50 kHz	2%+.3 mV	3%+.5 mV	3%+.3 mV	4%+.5 mV
	50 kHz to 100 kHz	5%+.5 mV	5%+1 mV	7%+.5 mV	8%+1 mV
3V	20 to 50 Hz	3%+2.5 mV	6%+5 mV	3.5%+2.5 mV	7%+5 mV
	50 to 150 Hz	0.4%+2.5 mV	1%+5 mV	0.5%+2.5 mV	1.2%+5 mV
	150 Hz to 10 kHz	0.3%+2.5 mV	1%+5 mV	0.4%+2.5 mV	1.2%+5 mV
	10 kHz to 20 kHz	0.4%+2.5 mV	1%+5 mV	0.5%+2.5 mV	1.2%+5 mV
	20 kHz to 50 kHz	1%+3 mV	1.5%+6 mV	1.5%+3 mV	2%+6 mV
	50 kHz to 100 kHz	2%+5 mV	3%+10 mV	3%+5 mV	4%+10 mV
30V	20 to 50 Hz	3%+25 mV	6%+50 mV	3.5%+25 mV	7%+50 mV
	50 to 150 Hz	0.4%+25 mV	1%+50 mV	0.5%+25 mV	1.2%+40 mV
	150 Hz to 10 kHz	0.3%+25 mV	1%+50 mV	0.5%+25 mV	1.2%+40 mV
	10 kHz to 20 kHz	0.4%+25 mV	1%+50 mV	0.5%+25 mV	1.2%+40 mV
	20 kHz to 50 kHz	1%+30 mV	1.5%+60 mV	1%+30 mV	2%+50 mV
	50 kHz to 100 kHz V<20V	2%+50 mV	3%+100 mV	2.5%+50 mV	4%+100 mV
150/300V	20 to 50 Hz	3%+.25V	6%+.50V	3.5%+.25V	7%+.50V
	50 to 150 Hz	0.4%+.25V	1%+.5V	0.5%+.25V	1.2%+.40V
	150 Hz to 2 kHz V*Hz>2*106	0.3%+.25V	1.2%+.5V	0.5%+.25V	1.4%+.40V
	2 kHz to 20 kHz V<100V	0.4%+.25V	1.6%+.5V	0.5%+.25V	1.8%+.40V
	20 kHz to 50 kHz V<40V	1%+.30V	2%+.6V	1.2%+.30V	2.5%+.50V

* Sine wave inputs>6% of scale. Accuracy for signals with crest factors <2.

2640A 4-Wire Resistance Measurement Specifications**A-15.**

Tables A-15 to A-17 provide 2640A specifications for the 4-wire resistance measurement function. The 4-wire measurements use 2 input channels a decade apart, e.g., channels 4 and 14.

Table A-15. 2640A 4-Wire Resistance Temperature Coefficient

Specification	Characteristic
Temperature Coefficient	Add 1/10th the 90 day specification per °C above 28°C or below 18°C.
Accuracy at -20°C	Multiply the -10°C to + 60°C accuracy specification by 2. After 1 hour warmup. For accuracy between -10°C and -20°C, interpolate linearly.

Table A-16. 2640A 4-Wire Resistance Range and Resolution Specifications

Range	Resolution		Current Applied	Full Scale Voltage	Maximum voltage applied by instrument
	Slow	Fast			
300Ω	1 mΩ	3 mΩ	1 mA	300 mV	3.5V
3 kΩ	10 mΩ	30 mΩ	100 μA	300 mV	3.5V
30 kΩ	100 mΩ	300 mΩ	10 μA	300 mV	3.5V
300 kΩ	1Ω	3Ω	10 μA	3.0V	3.5V
3 MΩ	10Ω	30Ω	1 μA	3.0V	3.5V

Table A-17. 2640A 4-Wire Resistance Accuracy Specifications

Range	Accuracy, $3\sigma \pm$ (% input + V)					
	18°C to 28°C				-10°C to 60°C	
	90 Day		1 Year		1 Year	
	Slow	Fast	Slow	Fast	Slow	Fast
300Ω	.015%+20 mΩ	.02%+80 mΩ	.02%+50 mΩ	.02%+120 mΩ	.084%+126 mΩ	.084%+336 mΩ
3kΩ	.02%+.3Ω	.02%+.8Ω	.02%+.5Ω	.02%+1.2Ω	.084%+1.26Ω	.084%+3.36Ω
30 kΩ	.03%+3Ω	.04%+10Ω	.03%+5Ω	.04%+15Ω	.126%+12.6Ω	.168%+42Ω
300 kΩ	.1%+40Ω	.2%+100Ω	.1%+60Ω	.2%+150Ω	.42%+168Ω	.84%+420Ω
3 MΩ*	.25%+800Ω*	.5%+10kΩ*	.25%+1 kΩ*	.5%+1.5kΩ*	1.05%+3.36Ω	2.1%+4.2 kΩ*

* The 3 MΩ range is susceptible to the absorption of humidity under extreme conditions. If the instrument is operated normally within its specified temperature-humidity range, the 3 MΩ range meets its accuracy specifications. However, if the instrument is "soaked" at 50°C, 90% RH the 3MΩ range may require 1 hour of "dry-out" time at 25°C, <40% RH for each hour of "soak" time in order to achieve its specified accuracy.

2640A 2-Wire Resistance Measurement Specifications

A-16.

The 2640A specifications for the 2-wire resistance measurement function is based on the 4-wire resistance measurement specification (above) except you add a nominal 5-Ohm (10-Ohm maximum) positive offset. This value varies for each channel and with temperature (nominal +1%/°C).

2640A RTD's 4-Wire, per ITS-1990 Measurement Specifications

A-17.

Tables A-18 and A-19 provide 2640A specifications for the 4-wire Resistance-Temperature Detector (RTD) measurement function. The 4-wire measurements use 2 input channels a decade apart, e.g., channels 4 and 14.

Table A-18. 2640A 4-Wire RTD Temperature Coefficient

Specification	Characteristic
Temperature Coefficient	To calculate RTD accuracy for temperatures between 28°C and 60°C, or -10°C and 18°C, use a linear interpolation between the two applicable points. e.g. if the applicable spec at 28°C is .2 and the spec at 60°C is .75, then the specification at 40°C = $(.75-.2) \times (40-28) / (60-28) + .2 = .55 \times (12/32) + .2 = .406$.
Accuracy at -20°C	Multiply the -10°C to + 60°C accuracy specification by 2. After 1 hour warm-up. For accuracy between -10°C and -20°C, interpolate linearly.

Table A-19. 2640A 4-Wire RTD Specifications

Temperature	Resolution		Accuracy, 3σ ±°C				
			90 Day, 18°C to 28°C		1 Year, 18°C to 28°C	1 Year, -10°C to 60°C	
	Slow	Fast	Slow	Fast	Slow	Slow	Fast
-200°C (Note1)	0.003°C	0.007°C	0.06°C	0.16°C	0.09°C	0.33°C	0.63°C
0°C (Note 1)	0.003°C	0.007°C	0.09°C	0.20°C	0.13°C	0.53°C	0.86°C
100°C	0.003°C	0.007°C	0.10°C	0.23°C	0.16°C	0.63°C	0.97°C
300°C	0.003°C	0.007°C	0.14°C	0.3°C	0.21°C	0.83°C	1.2°C
600°C	0.003°C	0.007°C	0.19°C	0.53°C	0.30°C	1.2°C	1.6°C

1. The Custom 385 range is not recommended for use below -80°C. (See Appendix D)

2640A RTD's 2-Wire per ITS-1990 Measurement Specifications A-18.

The 2640A specifications for the 2-wire Resistance-Temperature Detector (RTD) measurement function is based on the 4-wire RTD measurement specification (above) except you add a nominal 5-Ohm (roughly 13°C) positive offset. This value varies for each channel and temperature gradient (nominal +0.4%/°C). Also note that the resistance of the RTD wiring adds directly to the error. After 100 million operations of a measurement channel, the offset will increase at an indeterminate rate.

2640A Thermocouple per ITS-1990 Measurement Specifications A-19.

Tables A-20 to A-21 provide 2640A specifications for the thermocouple measurement function per ITS-1990.

Table A-20. 2640A Thermocouple General Specifications

Specification	Characteristic
Input Impedance	100 MΩ minimum in parallel with 300 pF
Open Thermocouple Detect	Operates by injecting a small ac signal into the input after each measurement. A thermocouple resistance greater than 1kΩ to 10kΩ is detected as an open input.
Temperature Coefficient	To calculate thermocouple accuracy for temperatures between 28°C and 60°C, or -10°C and 18°C, use a linear interpolation between the two applicable points. e.g., if the applicable spec at 28°C is .6 and the spec at 60°C is 1.1, then the spec at 40°C = $(1.1-.6)*(40-28)/(60-28)+.6 = .5 * (12/32) + .6 = .7875$.
Accuracy at -20°C	Multiply the -10°C to + 60°C accuracy specification by 2. After 1 hour warm-up. For accuracy between -10°C and -20°C, interpolate linearly.

Table A-21. 2640A Thermocouple Specifications

Thermocouple		Resolution	Accuracy ± °C				
			18°C to 28°C			-10°C to 60°C	
			90 Day	1 Year		1 Year	
Type	Temperature °C	Slow	Slow	Slow	Fast	Slow	Fast
J	-100 to 80	.03	0.45	0.50	0.80	0.60	0.80
	80 to 230	.02	0.35	0.50	0.70	0.60	0.80
	230 to 760	.02	0.40	0.50	0.70	0.80	0.90
K	-100 to -25	.04	0.55	0.60	0.90	0.70	1.00
	-25 to 120	.03	0.40	0.50	0.80	0.60	0.90
	120 to 800	.03	0.50	0.65	0.90	1.00	1.20
	800 to 1372	.03	0.70	1.00	1.30	1.60	1.90
N	-100 to -25	.05	0.65	0.75	1.20	0.80	1.30
	-25 to 120	.05	0.55	0.60	1.00	0.70	1.10
	120 to 1000	.04	0.45	0.60	0.90	1.00	1.20
	1000 to 1300	.03	0.55	0.75	1.00	1.20	1.50
E	-100 to -25	.03	0.45	0.50	0.80	0.60	0.80
	-25 to 20	.02	0.35	0.40	0.60	0.50	0.70
	20 to 600	.02	0.30	0.40	0.60	0.50	0.80
	600 to 1000	.02	0.40	0.50	0.70	0.90	1.00
T	-100 to 0	.04	0.60	0.65	1.00	0.70	1.10
	0 to 150	.03	0.40	0.50	0.80	0.60	0.90
	150 to 400	.02	0.30	0.40	0.60	0.60	0.80
R	250 to 600	0.1	0.90	1.00	2.10	1.20	2.20
	600 to 1500	0.1	0.80	0.90	1.80	1.30	2.00
	1500 to 1767	0.1	0.85	0.85	1.90	1.70	2.50
S	250 to 1000	0.1	0.95	1.10	2.30	1.30	2.40
	1000 to 1400	0.1	0.80	1.00	1.90	1.40	2.30
	1400 to 1767	0.1	1.00	1.30	2.20	1.80	2.80
B	600 to 900	0.2	1.20	1.40	3.10	1.50	3.20
	900 to 1200	0.2	0.90	1.00	2.20	1.20	2.40
	1200 to 1820	0.1	0.75	1.00	1.90	1.30	2.20
C	0 to 150	0.2	0.80	0.90	1.60	1.00	1.70
	150 to 650	0.1	0.65	0.75	1.40	1.00	1.50
	650 to 1000	.05	0.65	0.85	1.40	1.20	1.80
	1000 to 1800	.05	1.00	1.30	2.10	2.10	2.80
	1800 to 2316	.05	1.60	2.10	3.20	3.40	4.60

2640A Frequency Measurement Specifications**A-20.**

Tables A-22 to A-23 provide 2640A specifications for the frequency measurement function.

Table A-22. 2640A Frequency Accuracy Specifications

Frequency Measurement Accuracy, 1 Year, -10°C to 60°C				
Range	Resolution		Accuracy \pm (% input + Hz)	
	Slow	Fast	Slow	Fast
15 Hz to 900 Hz	0.01 Hz	0.1 Hz	0.05%+0.02 Hz	0.05%+0.2Hz
900 Hz to 9 kHz	0.1 Hz	1 Hz	0.05%+0.1 Hz	0.05%+1 Hz
9 kHz to 90 kHz	1 Hz	10 Hz	0.05%+1 Hz	0.05%+10 Hz
90 kHz to 900 kHz	10 Hz	100 Hz	0.05%+10 Hz	0.05%+100 Hz
1 MHz	100 Hz	1 kHz	0.05%+100 Hz	0.05%+1 kHz

Table A-23. 2640A Frequency Sensitivity Specifications

Frequency Measurement Sensitivity (Sine Wave)		
Frequency Range	Minimum Signal	Maximum Signal
15 Hz to 70 Hz	100 mV rms	$V < 150/300V$ rms* (depends on channel used) and $V * Hz < 2 * 10^6$
70 Hz to 100 kHz	100 mV rms	20V rms
100 kHz to 200 kHz	150 mV rms	10V rms
200 kHz to 300 kHz	150 mV rms	7V rms
300 kHz to 1 MHz	Linearly increasing from 150V rms at 300 kHz to 2V rms at 1 MHz	Linearly decreasing from 7V rms at 300 kHz to 2V rms at 1 MHz
* 300V range applies to channels 1 and 11 only.		

2645A Specifications

A-21.

This section includes specifications specific to the 2644A instrument by measurement function.

2645A DC Voltage Measurement Specifications

A-22.

Tables A-24 to A-26 provide 2645A specifications for the dc voltage measurement function.

Table A-24. 2645A DC Voltage Measurement General Specifications

Specification	Characteristic
Input Impedance	100M Ω in parallel with 300 pF maximum for ranges $\leq 3V$ 10M Ω in parallel with 100 pF maximum for ranges $> 3V$
Normal Mode Rejection	50dB minimum at 50 Hz/60 Hz +0.1%, Slow Rate
Common Mode Rejection	120dB minimum at dc, 50 Hz/60 Hz +0.1%, 1k Ω imbalance, Slow Rate 80dB minimum at dc, 60 dB at 50 Hz/60 Hz +0.1%, 1k Ω imbalance, Medium and Fast Rates
Channel-to-Channel Crosstalk	120dB minimum Slow Rate (e.g., 30V dc on channel 1 may cause a 30 μV error on channel 2) 80dB minimum Medium and Fast Rates (e.g., 1V dc on channel 1 may cause a 10 μV error on channel 2)
Temperature Coefficient	For % input: Add 1/10th the 90-day specification per $^{\circ}C$ above 28 $^{\circ}C$ or below 18 $^{\circ}C$. For floor error (V): add 1/20th the 90-day specification per $^{\circ}C$ above 28 $^{\circ}C$ or below 18 $^{\circ}C$
Accuracy at -20 $^{\circ}C$	Multiply the -10 $^{\circ}C$ to + 60 $^{\circ}C$ accuracy specification by 2. After 1 hour warm-up. For accuracy between -10 $^{\circ}C$ and -20 $^{\circ}C$, interpolate linearly.
Maximum Input Voltage	The lesser voltage of: 50V dc or 30V ac rms from any input terminal to earth -or- 50V dc or 30V ac rms from any input terminal to any other input terminal

Table A-25. 2645A DC Voltage Resolution and Repeatability Specifications

Range	Resolution	
	Slow	Fast
90 mV	3 μ V	6 μ V
300 mV	10 μ V	20 μ V
3V	100 μ V	200 μ V
30V	1 mV	2 mV
50V/300V*	10 mV	20 mV

* 300V range applies to channels 1 and 11 only.

Table A-26. 2645A DC Voltage Accuracy Specifications

Range	Accuracy, $3\sigma \pm$ (% input + V)					
	18°C to 28°C				-10°C to 60°C	
	90 Day		1 Year		1 Year	
	Slow	Fast	Slow	Fast	Slow	Fast
90 mV	.01%+20 μ V	.01%+50 μ V	.013%+23 μ V	.013%+50 μ V	.042%+52 μ V	.042%+130 μ V
300 mV	.01%+40 μ V	.01%+90 μ V	.013%+49 μ V	.013%+93 μ V	.042%+104 μ V	.042%+234 μ V
3V	.01%+.3 mV	.01%+.6 mV	.013%+.38 mV	.013%+.64 mV	.042%+.78 mV	.042%+1.56 mV
30V	.01%+4 mV	.02%+8 mV	.013%+4.9 mV	.026%+9.5 mV	.042%+10.6 mV	.084%+20.3 mV
50V	.01%+30 mV	.04%+60 mV	.013%+40 mV	.052%+64 mV	.042%+78 mV	.168%+156 mV

2645A AC Voltage Measurement Specifications

A-23.

Tables A-27 to A-29 provide 2645A specifications for the ac voltage measurement function.

Table A-27. 2645A AC Voltage General Specifications

Specification	Characteristic
Input Impedance	1 M Ω in parallel with 100 pF
Maximum Crest Factor	3.0 Maximum 2.0 for rated accuracy
Crest Factor Error	For non-sinusoidal input signals with crest factors between 2 and 3 and pulse widths $\geq 100 \mu\text{s}$, add 0.2% to the accuracy specifications.
Common Mode Rejection	80dB minimum at dc, 50 Hz/60 Hz $\pm 0.1\%$, 1 k Ω imbalance, Slow Rate
Maximum Input Voltage	The lesser voltage of: 30V ac rms from any input terminal to earth. 30V ac rms from any terminal input to any other input terminal.
Maximum Volt-Hertz Product	2x10 ⁶ Volt-Hertz product on any range, normal mode input. 1x10 ⁶ Volt-Hertz product on any range, common mode input.
Temperature Coefficient	Linear interpolation between 2 applicable points for temperatures between 28°C and 60°C, or -10°C and 18°C, e.g., if the applicable specification at 28°C is 2% and the specification at 60°C is 3%, then the specification at 40°C is $(3\%-2\%)\times(40-28)/(60-28)+2\%=2.375\%$.
Accuracy at -20°C	Multiply the -10°C to + 60°C accuracy specification by 2. After 1 hour warm-up. For accuracy between -10°C and -20°C, interpolate linearly.
DC Component Error	The presence of a dc voltage will cause an indeterminate error in the reading of the ac voltage on the input.

Table A-28. 2645A AC Voltage Range and Resolution Specifications

Range	Resolution		Minimum Input for Rate Accuracy
	Slow	Fast	
Full Scale	±30,000	±3,000	—
300 mV	10 µV	100 µV	20 mV
3V	100 µV	1 mV	200 mV
30V	1 mV	10 mV	2V

Table A-29. 2645A AC Voltage Accuracy Specifications

Range	Frequency	1 Year Accuracy ± (%input + V)*			
		18°C to 28°C		-10°C to 60°C	
		Slow	Fast	Slow	Fast
300 mV	20 to 50 Hz	3%+.25 mV	6%+.5 mV	3.5%+.25 mV	7%+.5 mV
	50 to 150 Hz	0.4%+.25 mV	0.8%+.5 mV	0.5%+.25 mV	1%+.5 mV
	150 Hz to 10 kHz	0.3%+.25 mV	0.8%+.5 mV	0.4%+.25 mV	1%+.5 mV
	10 kHz to 20 kHz	0.4%+.25 mV	1%+.5 mV	0.7%+.25 mV	1.5%+.5 mV
	20 kHz to 50 kHz	2%+.3 mV	3%+.5 mV	3%+.3 mV	4%+.5 mV
3V	50 kHz to 100 kHz	5%+.5 mV	5%+1 mV	7%+.5 mV	8%+1 mV
	20 to 50 Hz	3%+2.5 mV	6%+5 mV	3.5%+2.5 mV	7%+5 mV
	50 to 150 Hz	0.4%+2.5 mV	0.8%+5 mV	0.5%+2.5 mV	1%+5 mV
	150 Hz to 10 kHz	0.3%+2.5 mV	0.6%+5 mV	0.4%+2.5 mV	1%+5 mV
	10 kHz to 20 kHz	0.4%+2.5 mV	0.8%+5 mV	0.5%+2.5 mV	1%+5 mV
30V	20 kHz to 50 kHz	1%+3 mV	1.5%+6 mV	1.5%+3 mV	2%+6 mV
	50 kHz to 100 kHz	2%+5 mV	3%+10 mV	3%+5 mV	4%+10 mV
	20 to 50 Hz	3%+50 mV	6%+100 mV	3.5%+50 mV	7%+100 mV
	50 to 150 Hz	1%+50 mV	1.5%+100 mV	1.2%+50 mV	2%+100 mV
	150 Hz to 10 kHz	0.4%+25 mV	0.6%+50 mV	1.2%+25 mV	1.3%+40 mV
V<20V	10 kHz to 20 kHz	0.4%+25 mV	0.8%+50 mV	1.2%+25 mV	1.3%+40 mV
	20 kHz to 50 kHz	1%+30 mV	1.5%+60 mV	1.2%+30 mV	2%+50 mV
	50 kHz to 100 kHz	2%+50 mV	3%+100 mV	2.5%+50 mV	4%+100 mV

* Sine wave inputs >6% of scale and signals with crest factors <2.

2645A 4-Wire Resistance Measurement Specifications

A-24.

Tables A-30 to A-32 provide 2645A specifications for the 4-wire resistance measurement function. The 4-wire measurements use 2 input channels a decade apart, e.g., channels 4 and 14.

Table A-30. 2645A 4-Wire Resistance Temperature Coefficient

Specification	Characteristic
Temperature Coefficient	Add 1/10th the 90 day specification per °C above 28°C or below 18°C.
Accuracy at -20°C	Multiply the -10°C to + 60°C accuracy specification by 2. After 1 hour warm-up. For accuracy between -10°C and -20°C, interpolate linearly.

Table A-31. 2645A 4-Wire Resistance Range and Resolution Specifications

Range	Resolution		Current Applied	Full Scale Voltage	Maximum Voltage Applied
	Slow	Fast			
300Ω	10 mΩ	30 mΩ	1 mA	300 mV	3.5V
3 kΩ	100 mΩ	300 mΩ	100 μA	300 mV	3.5V
30 kΩ	1Ω	3Ω	10 μA	300 mV	3.5V
300 kΩ	10Ω	30Ω	10 μA	3.0V	3.5V
3 MΩ	100Ω	300Ω	1 μA	3.0V	3.5V

Table A-32. 2645A 4-Wire Resistance Accuracy Specifications

Range	Accuracy, $3\sigma \pm$ (% input + V)					
	18°C to 28°C				-10°C to 60°C	
	90 Day		1 Year		1 Year	
	Slow	Fast	Slow	Fast	Slow	Fast
300Ω	.02%+60 mΩ	.02%+.1Ω	.02%+.1Ω	.02%+.2Ω	.084%+.25Ω	.084%+.42Ω
3 kΩ	.02%+.6Ω	.02%+2Ω	.02%+1Ω	.02%+3Ω	.084%+2.5Ω	.084%+8.4Ω
30 kΩ	.02%+6Ω	.2%+200Ω	.02%+10Ω	.2%+300Ω	.084%+25Ω	.84%+840Ω
300 kΩ	.5%+80Ω	1%+2 kΩ	.5%+150Ω	1%+3 kΩ	2.1%+336Ω	4.2%+8.4 kΩ
3 MΩ	1.3%+1 kΩ	2%+120 kΩ	1.3%+2 kΩ	2%+200 kΩ	5.46%+4.2 kΩ	8.4%+200 kΩ

2645A 2-Wire Resistance Measurement Specifications**A-25.**

The 2645A specifications for the 2-wire resistance measurement function is based on the 4-wire resistance measurement specification (above) except you add a 700 to 1000 Ohm positive offset. This value varies for each channel and temperature gradient (nominal +1%/°C).

2645A 4-Wire RTD per ITS-1990 Measurement Specifications**A-26.**

Tables A-33 and A-34 provide 2645A specifications for the 4-wire Resistance-Temperature Detector (RTD) measurement function. The 4-wire measurements use 2 input channels a decade apart, e.g., channels 4 and 14.

Table A-33. 2645A 4-Wire RTD Temperature Coefficient

Specification	Characteristic
Temperature Coefficient	To calculate RTD accuracy for temperatures between 28°C and 60°C, or -10°C and 18°C, use a linear interpolation between the two application points. e.g., if the applicable spec at 28°C is .2 and the spec at 60°C is .75, then the specification at 40°C is $(.75-.2)*(40-28)/(60-28) + .2 = .55*(12/32)+.2 = .406$.
Accuracy at -20°C	Multiply the -10°C to + 60°C accuracy specification by 2. After 1 hour warm-up. For accuracy between -10°C and -20°C, interpolate linearly.

Table A-34. 2645A 4-Wire RTD Specifications

Temperature	Resolution		Accuracy, $3\sigma \pm ^\circ\text{C}$				
			90 Day, 18°C to 28°C		1 Year, 18°C to 28°C	1 Year, -10°C to 60°C	
	Slow	Fast	Slow	Fast	Slow	Slow	Fast
-200°C*	0.03°C	0.06°C	0.16°C	0.25°C	0.25°C	0.62°C	1.10°C
0°C*	0.03°C	0.06°C	0.20°C	0.31°C	0.31°C	0.85°C	1.30°C
100°C	0.03°C	0.06°C	0.23°C	0.34°C	0.34°C	0.95°C	1.40°C
300°C	0.03°C	0.06°C	0.30°C	0.41°C	0.41°C	1.18°C	1.70°C
600°C	0.03°C	0.06°C	0.53°C	0.63°C	0.63°C	1.62°C	2.12°C

* The Custom-385 range is not recommended for use below -80°C. See Appendix D.

2645A Thermocouple per ITS-1990 Measurement Specifications A-27.

Tables A-35 to A-36 provide 2645A specifications for the thermocouple measurement function per ITS-1990.

Table A-35. 2645A Thermocouple General Specifications

Specification	Characteristic
Input Impedance	100 MΩ minimum in parallel with 150 pF
Open Thermocouple Detect	Operates by injecting a small ac signal into the input after each measurement. A thermocouple resistance greater than 1 kΩ to 10 kΩ is detected as an open input.
Temperature Coefficient	To calculate Thermocouple accuracy for temperatures between 28°C and 60°C, or -10°C and 18°C, use a linear interpolation between the two applicable points. e.g., if the applicable spec at 28°C is .6 and the spec at 60°C is 1.1, then the spec at 40°C is $(1.1-.6)*(40-28)/(60-28)+.6 = .5*(12.32) + .6 = .7875$.
Accuracy at -20°C	Multiply the -10°C to + 60°C accuracy specification by 2. After 1 hour warm-up. For accuracy between -10°C and -20°C, interpolate linearly.

Table A-36. 2645A Thermocouple Specifications

Thermocouple		Resolution	Accuracy ± °C				
			18°C to 28°C			-10°C to 60°C	
Type	Temperature °C		90 Day	1 Year		1 Year	
			Slow	Slow	Fast	Slow	Fast
J	-100 to 80	.3	0.8	0.9	1.6	0.9	1.7
	80 to 230	.2	0.7	0.8	1.4	0.9	1.5
	230 to 760	.2	0.7	0.8	1.3	1.0	1.5
K	-100 to -25	.4	1.0	1.1	2.0	1.2	2.1
	-25 to 120	.3	0.8	0.9	1.7	1.0	1.8
	120 to 1000	.3	0.9	1.1	1.8	1.5	2.2
	1000 to 1372	.3	1.2	1.5	2.3	2.0	2.9
N	-100 to -25	.5	1.4	1.5	2.8	1.5	2.9
	-25 to 120	.5	1.1	1.3	2.3	1.3	2.4
	120 to 1000	.4	1.0	1.1	2.0	1.2	2.1
	1000 to 1300	.3	1.0	1.2	1.9	1.6	2.4

Table A-36. 2645A Thermocouple Specifications (cont)

Thermocouple		Resolution	Accuracy \pm °C				
			18°C to 28°C			-10°C to 60°C	
Type	Temperature °C		90 Day	1 Year		1 Year	
			Slow	Slow	Fast	Slow	Fast
E	-100 to -25	.3	0.8	0.9	1.5	1.0	1.6
	-25 to 20	.2	0.7	0.7	1.2	0.8	1.3
	20 to 600	.2	0.6	0.7	1.1	0.8	1.2
	600 to 1000	.2	0.6	0.8	1.2	1.1	1.5
T	-100 to 0	.4	1.1	1.2	2.2	1.3	2.3
	0 to 150	.3	0.9	1.0	1.7	1.0	1.8
	150 to 400	.2	0.7	0.8	1.4	0.8	1.5
R	250 to 600	1	2.4	2.7	5.6	2.8	5.7
	600 to 1500	1	2.0	2.3	4.6	2.4	4.8
	1500 to 1767	1	2.0	2.3	4.5	2.8	5.1
S	250 to 1000	1	2.6	2.8	5.9	2.9	6.0
	1000 to 1400	1	2.0	2.3	4.6	2.6	5.0
	1400 to 1767	1	2.3	2.7	5.3	3.3	5.9
B	600 to 1200	2	3.6	3.9	8.5	4.0	8.6
	1200 to 1550	2	2.1	2.4	5.0	2.6	5.2
	1550 to 1820	1	2.0	2.3	4.7	2.7	5.0
C	0 to 150	2	1.9	2.0	4.0	2.1	4.2
	150 to 650	1	1.6	1.7	3.5	1.8	3.6
	650 to 1000	.5	1.4	1.7	3.2	2.0	3.5
	1000 to 1800	.5	2.0	2.5	4.5	3.2	5.3
	1800 to 2316	.5	3.1	3.8	6.8	5.1	8.1

2645A Frequency Measurement Specifications

A-28.

Tables A-37 to A-38 provide 2645A specifications for the frequency measurement function.

Table A-37. 2645A Frequency Accuracy Specifications

Frequency Measurement Accuracy, 1 Year, -10°C to 60°C				
Range	Resolution		Accuracy \pm (% input + Hz)	
	Slow	Fast	Slow	Fast
15 Hz to 900 Hz	0.01 Hz	0.1 Hz	0.05%+0.02 Hz	0.05%+0.2 Hz
900 Hz to 9 kHz	0.1 Hz	1 Hz	0.05%+0.1 Hz	0.05%+1 Hz
9 kHz to 90 kHz	1 Hz	10 Hz	0.05%+1 Hz	0.05%+10 Hz
90 kHz to 900 kHz	10 Hz	100 Hz	0.05%+10 Hz	0.05%+100 Hz
1 MHz	100 Hz	1 kHz	0.05%+100 Hz	0.05%+1 kHz

Table A-38. 2645A Frequency Sensitivity Specifications

Frequency Measurement Sensitivity (Sine Wave)		
Frequency Range	Minimum Signal	Maximum Signal
15 Hz to 70 kHz	100 mV rms	30V rms
70 kHz to 100 kHz	100 mV rms	20V rms
100 kHz to 200 kHz	150 mV rms	10V rms
200 kHz to 300 kHz	150 mV rms	7V rms
300 kHz to 1 MHz	Linearly increasing from 150V ms at 300 kHz to 2V rms at 1 MHz	Linearly decreasing from 7V rms at 300 kHz to 2V rms at 1 MHz

Appendix B Noise, Shielding, and Crosstalk Considerations

Introduction

B-1.

This appendix supplies information on how you can setup your instruments to minimize measurement errors. The topics include static versus dynamic measurement, noise and shielding, and how to minimize crosstalk effects

Static Versus Dynamic Measurements

B-2.

Some signals change value slowly. Other change rapidly. At some point things change quickly enough that we call the signals dynamic rather than static.

Frequently, one wishes to analyze dynamic signals in the frequency domain. However, if you wish to do that, you must use an anti-aliasing filter (a low pass filter with a sharp cutoff above the highest frequency of interest) ahead of every input that is to be digitized and you must sample at a frequency at least two times that of the transition band of the filter..

The 2640A/2645A instruments do not have an anti-aliasing filter built-in. They are not suitable for digitizing dynamic signals unless you put a suitable anti-aliasing filter in series with each input. Note that a suitable anti-aliasing filter is a low-pass filter with at least 3 poles and a fairly sharp cutoff characteristic. Good anti-aliasing filters have as many as 8 poles.

Noise and Shielding

B-3.

An additional manifestation of aliasing can appear even in static readings. If there is noise coupled into the signal wiring from power mains wiring, it usually appears as noise in the readings. However, it is possible to accidentally combine a fast

reading rate and scan interval that is an exact multiple of the power line period and cause line frequency noise to be aliased to a very low frequency, where it appears as drift, or instability, in the readings. For example, if the instrument is set to Reading Rate = Fast and a scan interval of 100 ms, line frequency noise is aliased because the scan interval is an exact multiple of the period of the power line.

One way to see whether your measurement setup has a potential problem like this is to pick a scan interval like 98 ms or 102 ms, that is not an exact multiple of the power line period. If the readings appear noisier with this scan interval than with an interval of 100 ms, there is a problem with the measurement setup. Possible solutions to this problem are:

1. Use shielded wiring to prevent power line noise pickup from mixing with the signal. Be sure the shield is connected to an earth ground.
2. Route signal wiring away from power mains wiring.
3. Remove noise from the signal using filters before the signal is applied to the instrument.
4. Select Reading Rate = Slow, which allows the instrument to filter out the noise.
5. Ensure that the chassis of the instrument is connected to earth ground. This is desirable for reasons of safety as well as noise.

Crosstalk Considerations

B-4.

The accuracy of low voltage measurements (e.g., thermocouples), low voltage ac measurements and resistance measurements above 3 k Ω can be greatly affected by undesired pickup from ac voltage sources (crosstalk). To reduce the effects of crosstalk, consider each of the following:

1. **Reading Rate** Do not use Reading Rate = Fast when mixing vac or frequency inputs with low level vdc, thermocouple, and/or resistance inputs. If you must use Reading Rate = Fast, compare a set of readings taken with Reading Rate = Slow against a set of readings taken on the Fast rate to determine the effects of crosstalk on your setup. Measurements made at the Fast reading rate are more susceptible to crosstalk than readings taken at the Slow reading rate.

Note

When you use the Fast rate, it is very easy to get noise into your readings. The Fast rate makes it possible to look at rapidly changing events, but it requires extreme care to keep the readings clean.

2. **Shielded Wiring** Crosstalk can occur outside the instrument as well as inside the instrument. Use shielded wiring and tie the shields to an earth ground to prevent noise from being coupled into your measurements. Be careful about

the routing of your input wiring: keep it away from or shielded from all ac power mains wiring and other sources of noise.

3. **Channel Spacing** When possible, leave as many unused channels as possible between your ac voltage channel inputs and your low level inputs.

Crosstalk from a VAC or frequency signal on a 2645A channel to an adjacent channel using the Slow reading rate is as shown in Table B-1:

Table B-1. 2645A Crosstalk Specifications.

VAC/Frequency	Volts DC	Resistance	Temperature (100 Ohm RTD)	Temperature (Thermocouple)
<100 Hz	-80 dB	.2%/V if R>3k	.04°/V	.1°/V
100 Hz	-100 dB	.1%/V if R>3k	.02°/V	.003°/V
500 Hz	-100 dB	.1%/V if R>3k	.02°/V	.03°/V
1 kHz	-50 dB	.1%/V if R>3k	.02°/V	.3°/V
2 kHz	-60 dB	.05%/V if R>3k	.02°/V	.1°/V
5 kHz	-66 dB	.1%/V if R>3k	.02°/V	.1°/V
10 kHz	-80 dB	.01%/V	.02°/V	.1°/V
20 kHz	-50 dB	.02%/V	.05°/V	.1°/V
50 kHz	-40 dB	.05%/V	.1°/V	.5°/V
100 kHz	-40 dB	.1%/V	.2°/V	1°/V
>100 kHz	-40 dB	.1%/V	.4°/V	2°/V

Note 1 The temperature ranges are particularly susceptible to crosstalk at frequencies above 20 kHz, and that the error goes up as the square of the voltage, e.g., 2V ac at 100 kHz can cause a 4 degree error on a thermocouple. Because of this sensitivity, it is not advisable to mix temperature signals and high frequency signals in the same 2645A.

Crosstalk from a VAC or frequency signal on a 2640A channel to an adjacent channel using the slow reading is as shown in Table B-2.

Table B-2. 2640A Crosstalk Specifications

Frequency	VDC 1 kΩ source	Resistance		100Ω RTD	Thermocouple
		R <20 kΩ	R >20 kΩ		
<100 Hz	-120 dB	.001%/V	.01%/V*MΩ	.001°/V	.001°/V
100 Hz	-120 dB	.001%/V	.05%/V*MΩ	.001°/V	.003°/V
500 Hz	-120 dB	.001%/V	.05%/V*MΩ	.001°/V	.01°/V
1 kHz	-100 dB	.001%/V	.05%/V*MΩ	.001°/V	.01°/V
2 kHz	-60	.001%/V	.1%/V*MΩ	.001°/V	.01°/V ²
5 kHz	.01 mV/V ²	.005%/V ²	Not recomm.	.001°/V ²	.01°/V ²
10 kHz	.01 mV/V ²	.005%/V ²	Not recomm.	.01°/V ²	.05°/V ²
20 kHz	.05 mV/V ²	.01%/V ²	Not recomm.	.01°/V ²	Not recomm.
50 kHz	.1 mV/V ²	.01%/V ²	Not recomm.	.01°/V ²	Not recomm.
100 kHz	.1 mV/V ²	.01%/V ²	Not recomm.	.01°/V ²	Not recomm.
>500 kHz	.1 mV/V ²	.1%/V ²	Not recomm.	.01°/V ²	Not recomm.

For frequencies below 5 kHz, the 2640A is roughly 10 times more susceptible to crosstalk at frequencies that are exact multiples of 300 Hz than it is at the frequencies shown above. e.g., the sensitivity at 3 kHz will be about 10 times worse than at 2 kHz or 5 kHz.

The above table indicates the amount of crosstalk interference caused by applying VAC to one other channel. If VAC (or frequency) inputs are applied to multiple channels, multiply the value in the table by the number of channels with VAC (or frequency) applied.

Appendix C

True-RMS Measurements

Introduction

C-1.

The instrument measures the true rms value of ac voltages. In physical terms, the rms (root-mean-square) value of an waveform is the equivalent dc value that causes the same amount of heat to be dissipated in a resistor. True rms measurement greatly implies the analysis of complex ac signals. Since the rms value is the dc equivalent of the original waveform, it provides a reliable basis for comparing dissimilar waveforms.

Effects of Internal Noise in AC Measurements

C-2.

With the input shorted and the instrument set for ac volts (VAC) measurement, internal amplifier noise causes a typical display reading of approximately 0.50 mV ac. Since the instrument is a true rms responding measurement device, this noise contributes minimally to the readings at the specified floor of each range. When the rms value of the two signals (internal noise and range floor) is calculated, the effect of the noise is shown as:

$$\text{Total rms digits} = \text{Square Root of } (0.50^2 + 15.00^2) = 15.008$$

The display will read 15.01. At the 28.00 mV input level on the 300.00 mV range in the slow rate, the display will read 28.00 with no observable error.

Waveform Comparison (True RMS vs Average Responding)



C-3.

Figure C-1 illustrates the relationship between ac and dc components for common waveforms and compares readings for true-rms measurements (NetDAQ) and average-responding measurements. For example, consider the first waveform, a 1.41421V (zero-to-peak) sine wave. Both the instrument and rms-calibrated average-responding measurement devices display the correct rms reading of

1.0000V ac (the dc component equals 0). However, consider the 2V (peak-to-peak) square wave.

Both types of measurement correctly display the dc component (0V), but the NetDAQ instrument also correctly measures the ac component (1.0000V). The average-responding device measures 1.11V, which amounts to an 11% error.

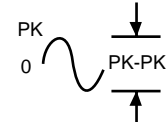
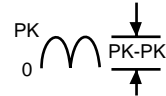
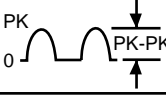
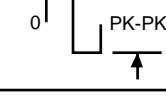
Average-responding measurement devices have been in use for a long time; you may have accumulated test or reference data based on such instruments. The conversion factors in Figure C-1 can help in converting between the two measurement methods.

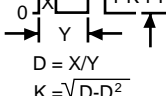
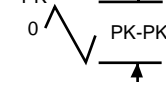
AC-COUPLED INPUT WAVEFORM	PEAK VOLTAGES		MEASURED VOLTAGES			DC AND AC TOTAL RMS
	PK-PK	0-PK	AC COMPONENT ONLY		DC COMPONENT ONLY	TRUE RMS = $\sqrt{ac^2 + dc^2}$
			RMS CAL*	HYDRA		
SINE 	2.828	1.414	1.000	1.000	0.000	1.000
RECTIFIED SINE (FULL WAVE) 	1.414	1.414	0.421	0.436	0.900	1.000
RECTIFIED SINE (HALF WAVE) 	2.000	2.000	0.779	0.771	0.636	1.000
SQUARE 	2.000	1.000	1.111	1.000	0.000	1.000
RECTIFIED SQUARE 	1.414	1.414	0.785	0.707	0.707	1.000
RECTANGULAR PULSE  $D = X/Y$ $K = \sqrt{D-D^2}$	2.000	2.000	$4.442 K^2$	2K	2D	$2\sqrt{D}$
TRIANGLE SAWTOOTH 	3.464	1.732	0.962	1.000	0.000	1.000

* RMS CAL IS THE DISPLAYED VALUE FOR AVERAGE RESPONDING INSTRUMENTS THAT ARE CALIBRATED TO DISPLAY RMS FOR SINE WAVES

Figure C-1. Comparison of Common Waveforms

Appendix D

RTD Linearization

Introduction

D-1.

This appendix discusses Fixed-385 and Custom-385 RTD measurements with NetDAQ.

Fixed-385 RTD

D-2.

The Fixed-385 RTD linearization uses segmented polynomials to approximate the Callendar Van-Dusen equation for a 385 RTD. R_0 may be specified via NetDAQ Logger but α , δ , and β are fixed. These fixed coefficients are the modified DIN 43760 coefficients that conform to ITS90:

$$\begin{aligned}\alpha &= 0.00385055 \\ \delta &= 1.49978574 \\ \beta &= 0.10863383\end{aligned}$$

The accuracy specifications of Fixed-385 measurements with a 385 RTD that matches the above coefficients are shown in Table A-34 in Appendix A.

Custom-385 RTD**D-3.**

The Custom-385 RTD linearization solves the Callendar Van-Dusen equation for positive temperatures and uses a polynomial approximation to the Callendar Van-Dusen equation for negative temperatures. In addition to R_0 , α may also be specified via NetDAQ Logger. δ and β are fixed. These fixed coefficients are the modified DIN 43760 coefficients that conform to ITS90:

$$\delta = 1.49978574$$

$$\beta = 0.10863383$$

Figure D-1 shows the accuracy envelope for a 385 RTD that has δ and β that match the above coefficients. Because of the error introduced by the linearization at low temperatures, it is recommended that use of the Custom-385 RTD type be limited to temperatures between -100 and 600°C.

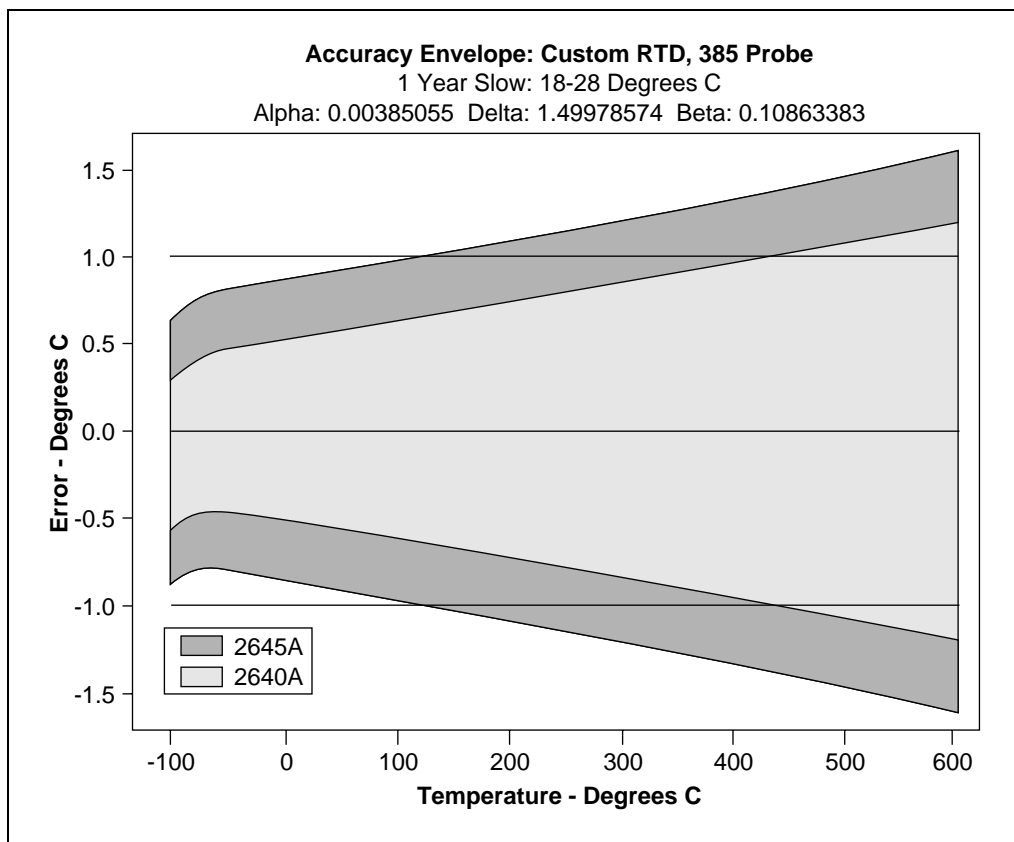

Figure D-1. 385 RTD

Using the Custom-385 RTD with Other Platinum RTDs

D-4.

Although the Custom-385 RTD linearization uses a β and δ from a 385 RTD, other RTD types can be used. The Custom-385 linearization will compensate for the change in α , but errors will be introduced due to the difference in the δ and β coefficients of the RTD and the fixed coefficients. Figure D-2 shows the accuracy envelope for a 375 RTD. Because of the error introduced by the approximation and the difference in δ it is recommended that the use of the 375 RTD be limited to temperatures between -100°C and 300°C . Figure D-3 shows the accuracy envelope for a 391 RTD and Figure D-4 shows the accuracy envelope for a 392 RTD. Due to errors introduced by the approximation and the difference in δ it is recommended that the use of the 391 RTD and 392 RTD be limited to temperatures between -100°C and 600°C .

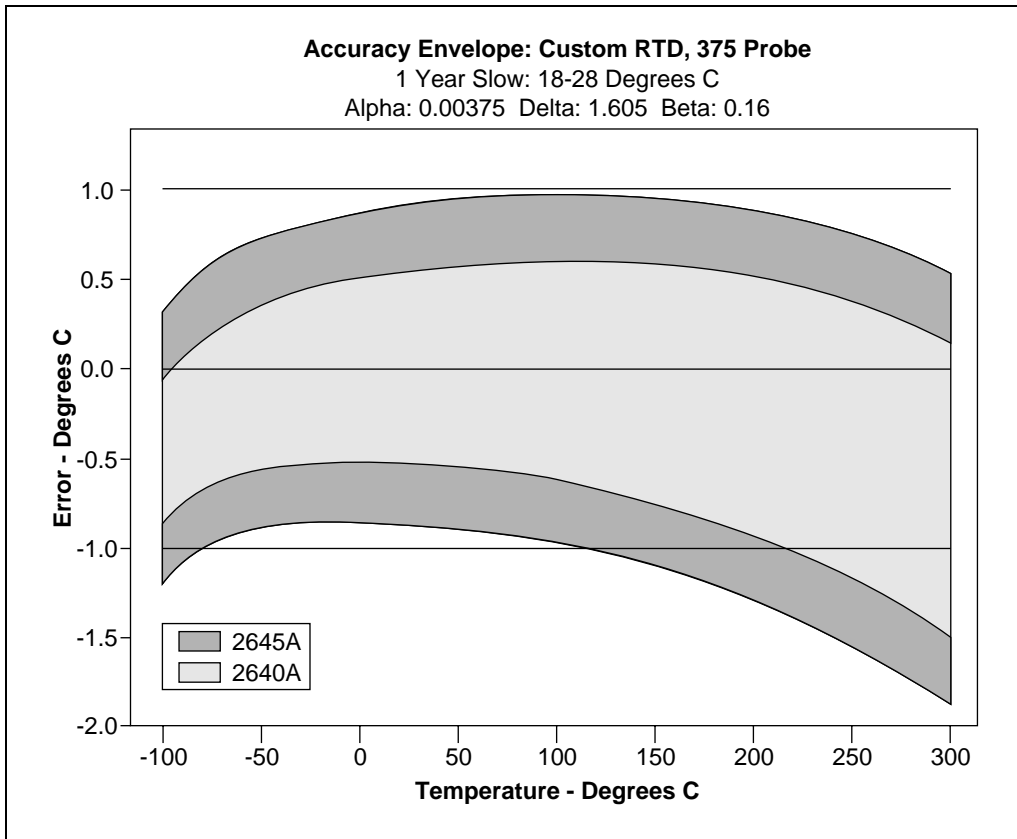

Figure D-2. 375 RTD

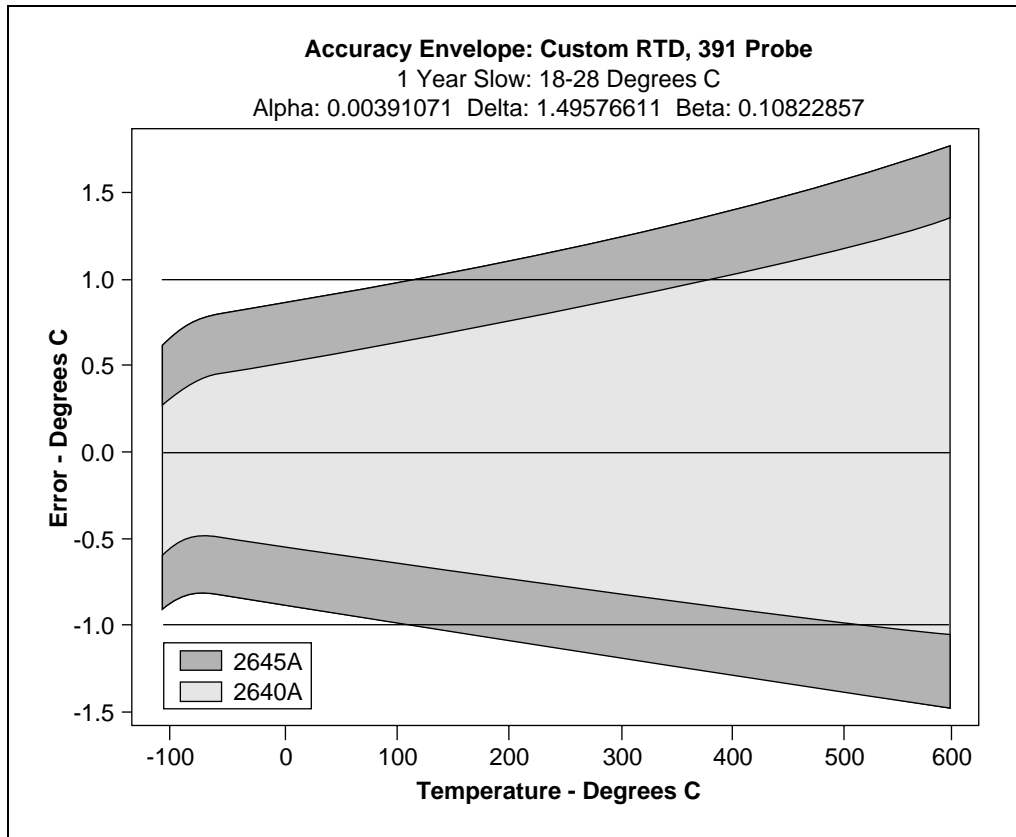

Figure D-3. 391 RTD

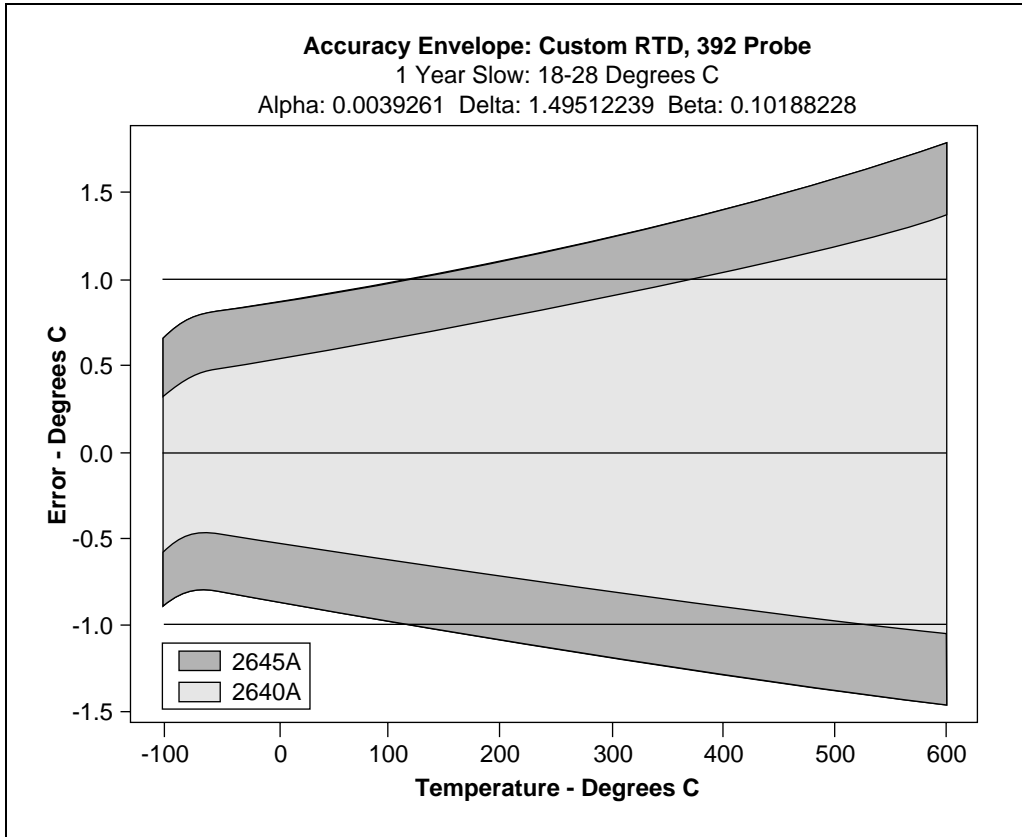

Figure D-4. 392 RTD

Appendix E

Computed Channel Equations

Introduction

E-1.

An equation is converted into a stored binary format which is sent to the instrument where the calculations are performed during the processing of each scan. Constants are passed to the instrument as single precision (4 byte) floating point numbers which have a maximum magnitude of $3.402823E38$. Calculations and intermediate values in the instrument use double precision (8 bytes) in order to preserve resolution. The resulting computed channel value is a single precision floating point number. When the result is $>9999.9E+6$ or $<-9999.9E+6$, NetDAQ Logger displays +OL or -OL for that channel, and changes the channel value to $+1.0E+9$ or $-1.0E+9$, according to the sign.

The instrument traps math errors such as divide by zero and $\log(0)$ and returns a non-numeric result which the logger reports as +OL. If a the value of a reference channel is non-numeric (indicating an open thermocouple or overload), that value will be returned for the computed channel.

Computed channel equations must observe the following syntax:

- White space is allowed, but not required, between symbols.
- White space and parentheses do contribute to the 100-character limit for the text string, but do not contribute to the size of the stored binary equation (all stored binary equations for an instrument cannot exceed 1000 bytes).
- Alphabetic characters may be in upper or lower case.

The symbols used in the syntax definition have the following meanings:

- $\langle \rangle$ enclose an element which needs further definition
- $\{ \}$ enclose elements that may be present zero or more times
- $[]$ enclose elements that may be present zero or one time
- $|$ separates alternative elements

” ” enclose literal characters or strings which must appear as shown (except for case)

() enclose groups of elements to clarify the scope of other symbols

<equation>	=	<add-term> { (“+” “-”) <add-term> }
<add-term>	=	<mul-term> { (“*” “/”) <mul-term> }
<mul-term>	=	<exp-term> { (“**”) <exp-term> }
<exp-term>	=	[(“+” “-”)] <operand>
<operand>	=	<channel> <constant> <function> “(“ <equation> ”)
<channel>	=	“C” <digit> [<digit>]
<constant>	=	<mantissa> [<exponent>]
<mantissa>	=	({<digit> } “.” <digit> { <digit> }) (<digit> {<digit> } [“.” {<digit> }])
<exponent>	=	“E” [“+” “-”] <digit> { <digit> }
<function>	=	<function-name> “(“ <equation> ”)
<function-name>	=	“ABS” “EXP” “INT” “LN” “LOG” “SQR”

Appendix F Data File Format

Introduction

F-1.

The ASCII (CSV) data file is maintained in comma-separated ASCII format. The ASCII format is compatible with data analysis and management tools running simultaneously in other computers on a network. A conversion utility, Binary to ASCII Conversion (Utilities menu) is provided for converting data files recorded in Fast Binary (BIN) to ASCII (CSV).

File Format

F-2.

The comma separated ASCII file format is as follows (<EOL> means “end of line”, a <CR><LF> sequence):

"File name string" <EOL>

"Date and time file was created" <EOL>

"File Comment" (< 70 character string) <EOL>

Number of Columns (including timestamp) <EOL>

Channel Units string (comma-separated strings) <EOL>

Scan Record 1 <EOL>

.

.

Scan Record n <EOL>

Data files from an asynchronous instrument contain channel readings from one instrument only. Data files from a group of instruments contain the time tag from the Master instrument and data from all the instruments in the group.

Each scan record consists of the instrument time tag and a comma separated list of channel readings (including the DIO word, totalizer, alarm1 and alarm2). The time tag format (Excel/Lotus) is:

For example, 14453.652384270 - indicates 04/29/94 15:39:26.001

Strings in the data file are quoted to allow direct importation into Microsoft Excel and other data analysis and presentation packages.

Appendix G

Dynamic Data Exchange (DDE)

Introduction

G-1.

Dynamic Data Exchange (DDE) provides NetDAQ Logger data to other Windows applications in real time. For example, with a DDE connection, data collected by NetDAQ Logger can be displayed in a spreadsheet as it is being collected from the instruments. This appendix includes a reference section for DDE and an example using the Microsoft Excel spreadsheet application.

DDE Links Reference

G-2.

DDE reference includes the Service Name, Topics, and Items:

Service Name	Topics	Items
NETDAQ for 16-bit NETDAQ32 for 32-bit	BCNnn (nn is the instrument BCN between 01 and 99.)	'Cnn' (nn is the channel number between 01 and 30.)
		DIO (The status of the eight Digital I/O lines are summarized in a decimal number between 0 and 255.)
		Totalizer (The status of the Totalizer is a number between 0 and 4294967294.)

DDE reference includes the Service Name, Topics, and Items: (cont)

Service Name	Topics	Items
NETDAQ for 16-bit NETDAQ32 for 32-bit		Alarm1 (The status of Alarm 1 for all 30 channels is summarized as a 30-bit binary number expressed in decimal.)
		Alarm2 (The status of Alarm 2 for all 30 channels is summarized as a 30-bit binary number expressed in decimal.)
		ELDateTime (The scan timestamp in Excel format.)
	System	Topics (System,BCN01, BCN02, etc)
		SysItems (Topics, SysItems, Formats)
		Formats (TEXT)

DDE Example Using Excel

G-3.

Complete the following procedure to make a DDE connection between NetDAQ Logger and an Excel spreadsheet. This is presented as an example where instrument BCN=25, is logging data from three configured channels, 13, 14, and 15 into Excel cells A1, A2, and A3 respectively.

1. In NetDAQ Logger, click the Start Instrument button to begin data collection. You do not have to be recording to a data file to use DDE.
2. Open Excel from the Applications group in Program Manager or from Start | Programs.

3. Select cell A1 on the spreadsheet, move the cursor to the Formula Bar and enter the *remote reference formula* to link cell A1 to instrument 25 channel 13, then <Enter>. (See below.)

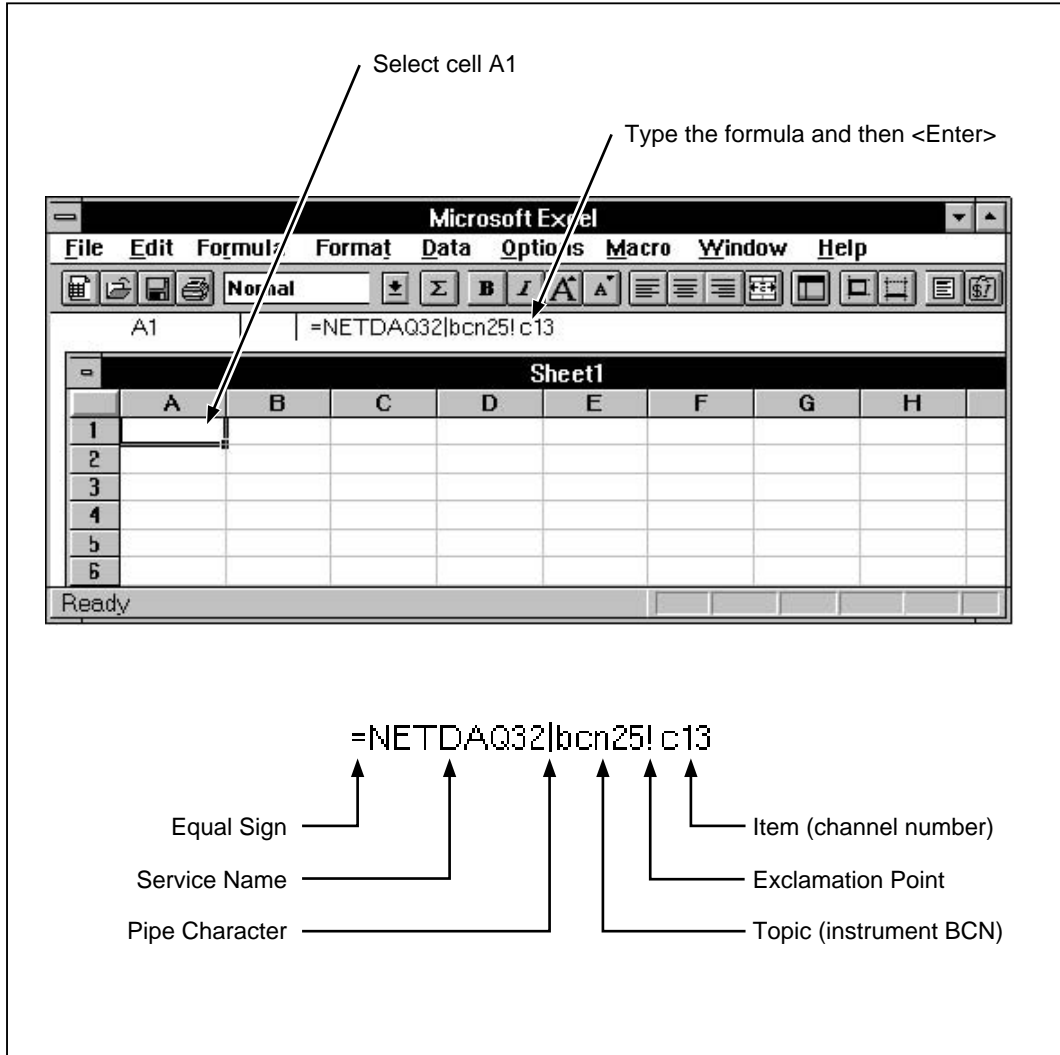

If the instrument is scanning, measurement data is displayed in cell A1.

4. In the same manner, select cell A2 and enter formula =NETDAQ32|bcn25!'c14' <Enter>; then select cell A3 and enter formula =NETDAQ32|bcn25!'c15' <Enter>.

5. Continue by entering the following:

Cell	Formula
A4	=NETDAQ32 bcn25!DIO
A5	=NETDAQ32 bcn25!Totalizer
A6	=NETDAQ32 bcn25!Alarm1
A7	=NETDAQ32 bcn25!Alarm2
A8	=NETDAQ32 bcn25!EIDateTime

6. Your entries will appear on the spreadsheet as shown below for the conditions entered in this example.

Note

The Excel formatting commands allow the Scan Time cell to display as a date/time (for example, 3/4/96, 12:04:00)

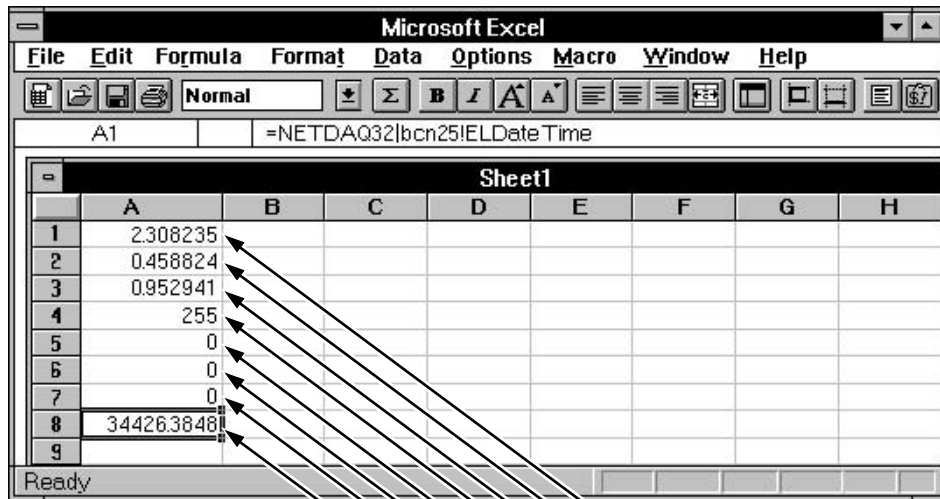

- Channel 13
- Channel 14
- Channel 15
- Digital I/O Status
- Totalizer Status
- Alarm 1 Value
- Alarm 2 Value
- Scan Time in Excell Format

A note about the Alarm 1 and Alarm 2 values reported in Excel:

The alarm value is the decimal equivalent of a 30-bit binary number represents the alarm conditions for each of the 30 instrument channels (20 analog and 10 computed channels).

In the simplest case, all 30 channel alarms are off and alarm value is 0. In the most complex case, all 30 channel alarms are on and the alarm value is 1073741823. See the following chart for Alarm Value examples.

29	28	27	26	25	24	23	22	21	20	19	18	17	16	15	14	13	12	11	10	9	8	7	6	5	4	3	2	1	0	BITS
30	29	28	27	26	25	24	23	22	21	20	19	18	17	16	15	14	13	12	11	10	9	8	7	6	5	4	3	2	1	CHANNEL
EXAMPLES																														
0	0	0	0	0	0	0	0	0	0	0	0	0	0	0	0	0	0	0	0	0	0	0	0	0	0	0	0	0	0	0
0	0	0	0	0	0	0	0	0	0	0	0	0	0	0	0	0	0	0	0	0	0	0	0	0	0	0	0	0	1	0
1	1	1	1	1	1	1	1	1	1	1	1	1	1	1	1	1	1	1	1	1	1	1	1	1	1	1	1	1	1	1
0	0	0	0	0	0	0	0	0	0	0	0	0	0	0	0	0	0	0	0	0	0	0	0	0	1	0	1	1	1	0
0	0	0	0	0	0	0	0	0	0	0	0	0	0	0	0	0	0	0	1	1	1	0	0	0	0	0	0	1	1	0
0	0	0	0	1	1	0	0	0	1	0	0	0	0	1	1	1	0	0	0	0	0	1	0	0	0	0	1	1	0	0
																													0	
																													1	
																													1073741823	
																													46	
																													1795	
																													51409030	
Alarm value 0 indicates no channels were in alarm for this scan. Alarm value 1 indicates channel 1 was in alarm for this scan. Alarm value 1073741823 indicates all channels were in alarm for this scan. Alarm value 46 indicates channels 6, 4, 3, and 2 were in alarm for this scan. Alarm value 1795 indicates channels 11, 10, 9, 2 and 1 were in alarm for this scan. Alarm value 51409030 indicates channels 26, 25, 21, 16, 15, 14, 8, 3, and 2 were in alarm for this scan.																														

ds072c.bmp

7. Continue with other Excel functions to show charts and features. (See your Excel documentation.)

For example, select cells A1, A2, and A3 (click on each cell while holding down the <Cntl> key), then select the New command from the File menu. Click on Chart and then OK. A chart is displayed for the three channels, which updates with each new measurement at a maximum rate of once per second (see the example below).

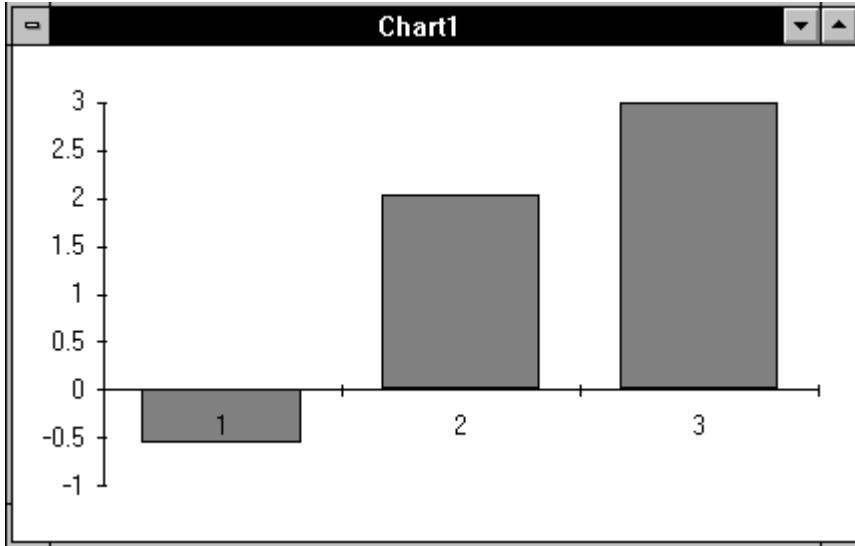

Appendix H

Ethernet Cabling

Introduction

H-1.

This appendix details the unshielded twisted-pair (UTP) cables used for 10BaseT Ethernet interconnection. UTP cable configurations are summarized in Figure H-1.

UTP Cables

H-2.

There are two types of UTP cables: patch cord cables and direct connection cables.

Patch cord cables connect an instrument or host computer to an existing 10BaseT hub, usually via a network outlet. A patch cord cable is characterized by pin-to-pin conformity (see Figure H-1).

Direct connection cables are used to make a direct connection between an instrument and a host computer. A direct connection cable is characterized by crossing the receive (RX) and transmit (TX) signals lines. This allows the RX line input to become a TX output, and vice versa (see Figure H-1). This signal reversal is a requirement when making a direct connection between an instrument and host computer. Be sure you use twisted-pairs for the RX and TX lines.

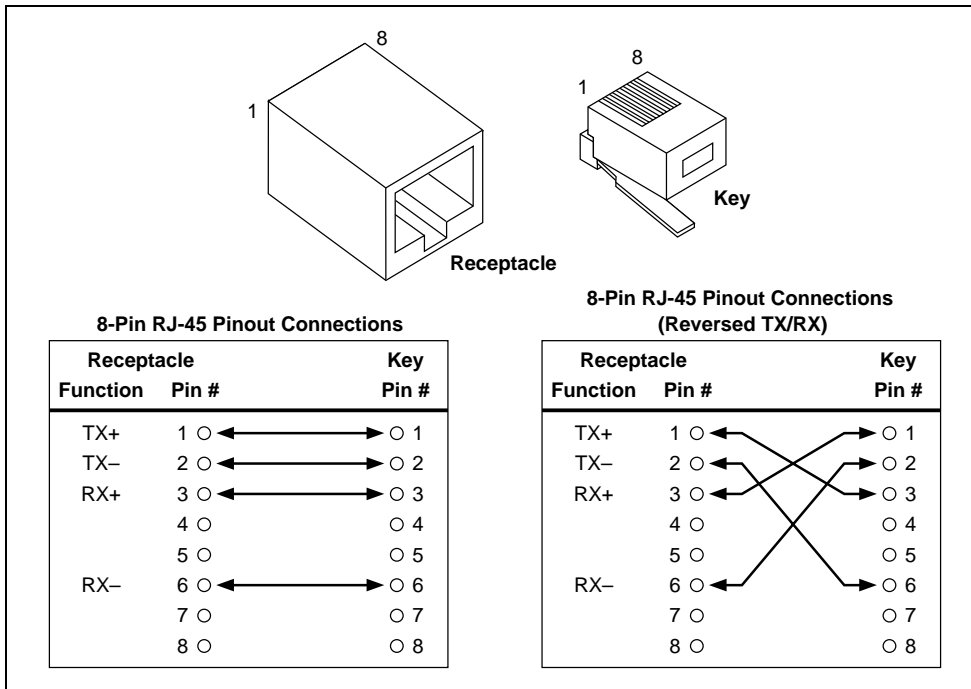

Figure H-1. 10BaseT Ethernet Cables

Appendix I

Network Considerations

Introduction

I-1.

This is a tutorial on commonly used Network communication technology and how to get started using the NetDAQ instruments. It's not necessary to know the details of Network communication methods in order to use NetDAQ effectively. However, there are such a wide variety of Network techniques and technology in use that you can become lost in the jargon used by Network Professionals.

This tutorial will attempt to take some of the mystery out of Networking. After all, Networking is just a way of communicating digital information from one point to another. Computer Networks are very similar to a postal service. Just like in postal services, in networks you can:

- Write a message.
- Assign a destination address.
- Add a return address on the message in case of delivery problems.
- Specify a delivery method (overnight, two day, etc.)
- Drop the message into the network.
- Expect the message to arrive at its destination some time later.

The software, hardware, and wiring of a network ensures that a message with proper addressing and type gets to its destination, and that errors are detected.

NetDAQ and Network Communication Techniques

I-2.

In the past, Fluke data acquisition instruments depended on RS-232 and IEEE-488 communication methods. This was OK with limited channel measurement rates,

low system data throughput because of the processing rate of host computers and disk systems, and instruments that are physically close to the host computer.

Now, the increased processing capability of affordable host computers, increased channel measurement rates, and pressure to place the instruments close to the signal source have made support of high-speed, long distance communication techniques necessary. At the same time, many companies are installing network wiring to support general client/server processing on Personal Computers.

Using networking techniques to communicate between the PC and the instrument has many advantages (and a few disadvantages). Advantages include:

- High data transfer rates
- Standard wiring methods and use of in-place wiring
- Standard protocols
- Low cost interface boards

Disadvantages include:

- Increased setup complexity
- Increased instrument power consumption (compared to RS-232)
- Additional interface in the PC

The NetDAQ instrument and host computer software use Ethernet wiring and low level protocols, TCP/IP high level protocols, and the WINSOCK application interface layer. These are all public domain, non-proprietary standards with multiple-company support. Use of these non-proprietary protocols and hardware ensures that NetDAQ instruments and software will operate on most installed networks and have the lowest possible cost using off-the-shelf commercial networking products. Read “Network Primer” in this appendix for more information on these standards.

NetDAQ and Your Network Administrator

I-3.

If you plan to communicate between your host PC and the NetDAQ instruments on a network that is totally isolated from any other network communication devices, you can install the network and set up the devices without consulting Network Administration. However, if you're going to communicate on an existing network, you need to coordinate this with your Network Administrator. Specifically, you need to ask the following questions before installing and setting up your instruments and host PC:

1. What values should I use for my IP addresses, Socket Port Number, and Subnet Mask?

2. Does the network contain more than one subnet? If so, what's the IP address of my default gateway or router device?
3. Will all the routers route IP packets?
4. What are my domain and host names (optional)?

The minimum information you need to get is the IP Addresses for the PC and the instruments. If your network contains more than one subnet and you want to place the PC and one or more instruments in different subnets, you must also set the default gateway address and subnet mask on both the NetDAQ instrument and the PC.

Your Network Administrator may also need to know the Ethernet addresses of the PC Ethernet adapter and each NetDAQ instrument that you will attach to the network. Obtain the Ethernet address of the PC by running the hardware setup program supplied with the adapter hardware. Obtain the address of the NetDAQ instruments by using the front panel controls.

Please read "Network Primer" in this appendix for more information on IP addressing and the other information needed to operate NetDAQ on a general network.

Network Primer

I-4.

In the early days of computer networking, vendors used many proprietary communication schemes. These forced users to purchase equipment and software from one or a few companies. As networking became more popular, users placed pressure on vendors to establish standards to allow interoperation of various types of computers, operating system software, and interface hardware.

One of these standardization efforts was started by the DARPA agency of the U.S. Defense department. Another was headed up by the DEC and Xerox companies. This effort resulted in the Ethernet wiring and low-level protocol scheme. The DARPA effort resulted in the TCP/IP high-level protocols. Ethernet became an international standard by the efforts of the IEEE-802.3 committee. TCP/IP is the protocol used on the international Internet Network and is supported by consensus of the users of that network (many thousands of hosts).

The Sockets API was developed at U.C. Berkeley and was widely adopted by the UNIX community to support direct Host-to-Host communication within a TCP/IP network. WINSOCK is an MS Windows Dynamic Link Library (DLL) version of the original UNIX Sockets library and has been standardized by a large number of PC Software and Hardware Vendors.

To reduce the complexity of network schemes and to encourage interoperation between varieties of networks, the protocols are built up of several layers that are isolated from each other by well-described interfaces. Usually, the lowest layers of the protocol are implemented in hardware logic on the interface circuits used by

the computers and other devices attached to the network wiring. The Ethernet standard consists of a set of low-level addressing and data transmission protocols that run on several different wiring schemes.

Computers on a network are usually referred to as a “host.” The NetDAQ instruments are hosts in this context. Devices that facilitate communication between different sections of a network are called by names that indicate their function, for example, routers, bridges, repeaters, etc.

Physical Layer Wiring Schemes Supported by NetDAQ

I-5.

NetDAQ supports two of the most common wiring schemes used in Ethernet networks: 10BaseT (or UTP), and 10Base2 (thin coax).

The 10Base2 wiring method uses coaxial cable (similar to cable TV wire). This simple wiring method supports many connections to the cable, allowing multiple instruments to be directly connected to the PC. The only trick to 10Base2 wiring is that a terminator must be connected to the cable at each open end. Fluke supplies a terminator with each NetDAQ instrument and wiring kit.

The 10BaseT wiring method uses two or four pairs of twisted wires. It is also referred to as Unshielded Twisted Pair (UTP) wiring. This wiring method supports only two connections to any one run of wire. To support more than two connections, an active device called a "hub" must be used.

A hub is an active device that supports multiple 10BaseT connections. The network host attached to each connection of the hub may communicate with every other host attached to the hub. Hubs also typically allow other types of cable connections, such as 10Base2 and 10Base5 (fat coax). This is done to allow a hub to communicate with other network hosts, such as other hubs, routers, bridges, etc.

If you want to use 10BaseT wiring without a hub (to connect one NetDAQ and one PC), you must use a special 10BaseT cable. This is necessary because both hosts transmit and receive on the same pair of wires within the cable. To operate correctly in a direct wiring situation, these pairs must be crossed in the cable, so that the transmitter on one end is connected to the receiver on the other.

The 10BaseT wiring method is becoming very popular because the wire is inexpensive to purchase and install, the use of a hub allows some protection from malfunctioning network hosts, and this type of wiring is easier for network administrators to manage and control.

Network Interconnection Devices

I-6.

The following five basic devices are used in networks to extend, partition, and interconnect networks:

- A *Repeater* is a device used to physically isolate and extend the length of a network segment, but it does not divide the network into subnets.
- A *hub* is a device that allows communication among multiple 10BaseT network hosts and allows these hosts to communicate with other Ethernet wiring. Some hubs also perform Router functions.
- A *Bridge* is used on Ethernet networks to isolate two portions of the network at the Frame level (see “Basic Network Packet and Frame Contents” in this appendix). This is done to minimize transmission collisions, but the two portions isolated by a Bridge remain on the same subnet. A Bridge also acts as a Repeater.
- A *Router* is used to isolate two portions of the network into subnets, as described in “IP Addresses and Segmented Networks” in this appendix. A Router also acts as a Bridge. Make sure your Router will route IP packets if you want to place the PC and NetDAQ instruments in different subnets.
- A *Gateway* is used to connect two networks with different architecture and protocols. For example, a Gateway could be used to connect an Ethernet to an X.25 net running on public telephone wiring. Gateways also perform Router, Bridge, and Repeater functions.

The operation of NetDAQ software and instruments should be unaffected by a properly designed network using any of these network devices. However, you must use extra care when setting up PCs and NetDAQ instruments in a network containing multiple subnets (net containing one or more routers and/or gateways). The IP addresses assigned to the PC and instruments must be carefully selected in this case. See “IP Addresses and Segmented Networks” for more information on IP address assignment.

When a Bridge, Router, or Gateway is used in a network containing NetDAQ instruments and hosts, be sure to reboot the host PC whenever an instrument is moved from one section of the net to another. This is required to allow the network hardware devices to initialize bridging and routing tables.

Also, when NetDAQ is used in a different subnet from the PC, the Routers and Gateways used to connect the subnets must be able to route IP packets. The default gateway addresses on the NetDAQ and PC must be set properly.

Basic Network Packet and Frame Contents

I-7.

Network messages consist of short (mostly less than 1K byte) hunks of data, surrounded by header and error detection information used by the protocols. The message, together with the protocol information, is called a "Packet." When physical network information (clock synchronization, error detection, etc.) is wrapped around the packet, it is called a "Frame." The interface hardware adds and

strips off the Frame information around the packet. So, unless you're doing low-level analysis of network traffic, you never need to deal with Frame information.

For any protocol, the Packet consists of a destination address, a source address, some protocol type information, a message length field, and error detection information.

The TCP/IP protocol adds additional fields to the packet for message sequence determination and application port ID. The sequence number allows multi-packet messages to be assembled into the correct order. The port ID specifies which application running on a system is sending or receiving the message. Support of port IDs allow multi-tasking within a computer system, with messages being sent and received from the individual task.

In the TCP/IP protocol, error detection is supported by adding a checksum of the data in the packet to the end of each packet. Using this checksum, the receiving system can detect a bad packet and request a re-transmit (using the source address).

Each *Host* (device attached to the network wiring) in an Ethernet network has a unique address that is assigned by the interface hardware vendor. Each vendor is assigned a block of addresses and it is required that each device produced have a unique Ethernet address. Users of the TCP/IP protocol very rarely need to know or deal with the Ethernet address.

When TCP/IP is used, each host is also assigned a unique IP address, but this address is assigned by the user when the TCP/IP protocol software is initialized. In contrast to the Ethernet address, IP addresses have a structure that can be used by Network Management to facilitate breaking the network into segments (subnets) that make better use of the available data communication capacity (bandwidth). Use of IP addressing and the network segmentation scheme is described in "IP Addresses and Segmented Networks" in this appendix.

The relationship between a host's Ethernet address and its IP address is established by the TCP/IP protocol software. No user interaction is needed to establish this relationship. However, some network management systems require that the Ethernet address of each network host be kept in a data base. So, it is sometimes necessary to communicate the Ethernet addresses of all devices on the network to the Network Administrator.

IP Addresses and Segmented Networks

I-8.

If all networks consisted of a few computers and other devices attached to each other locally, use of IP addressing and network segmentation schemes would not be necessary. However, networks have evolved past simple work groups into campus-wide, inter-campus, and even international interconnect schemes. This makes it necessary to divide the network into subnets.

The IP address provides two pieces of information: the *network ID* and the *host ID*. The network ID must be unique among all network subnets within a connected Internet. It identifies the network subnet to which a host is connected. The host ID must be unique among hosts within a network subnet and identifies the host within the subnet.

Network subnets connected to the public Internet must obtain an official network ID from the *Network Information Center* (800-444-4345 or nic@nic.ddn.mil) to preserve the unique network ID's within the Internet. However, if you never intend to connect to the Internet, you're free to select your own network IDs.

The IP address consists of four numbers. Each of these four numbers can have a value in the range 1 to 254. An IP address is written in the form w.x.y.z. For example, "198.178.246.10" (or "C6.B2.F6.0A" in hexadecimal) is a valid IP address.

There are three commonly used classes of IP address assignment as follows:

Class	w Value	Net ID	Host ID	Available Subnets	Available Hosts
A	1 to 126	w	x, y, z	126	16777214
B	128 to 191	w, x	y, z	16384	65534
C	192 to 223	w, x, y	z	2097151	254

The following are reserved addresses and may not be assigned to hosts:

127.0.0.0

128.0.0.0

191.255.0.0

192.0.0.0

223.255.255.0

w = 224 through 255 with x, y, and z equal to any value

Most IP subnets have Class B or C Net IDs because there are quite a few of these available. You may be able to get a Class A Net ID, but there are so few of these available (only 126 world-wide) that they are rarely issued and most are already assigned.

Most companies get one or more Class C assignments, which means that there is a limit of 254 hosts per network subnet.

The TCP/IP software separates the Net ID portion of the IP address from the Host ID portion using the user-assigned Subnet Mask. This mask looks like an IP address, but has a bit set in each bit position of the portion of the IP address that is in the Net ID portion. For example, the Subnet Mask 255.255.255.0 sets the Net

ID portion to be the higher order 24 bits of the IP address (a class C address). Using the Subnet Mask, the TCP/IP software is able to detect if a destination address is in the local subnet or if the packet must be sent to another subnet through a Router or Gateway.

Networks are segmented by use of an active device called a *Router* (*Gateways* and *hubs* sometimes have router capabilities.) When a host on one subnet wants to send a message to a host on another subnet (the Net ID sections of the IP source and destination are different), the Router is used to deliver the packet to the other network subnet.

NetDAQ instruments are shipped with a default IP address of 198.178.246.*bcn*, where *bcn* is the base channel number assigned to the instrument. This is a Class C Net ID assigned to the Fluke Corporation, so it is highly unlikely that it will overlap with a Net ID in use at your company. However, if you want to attach a NetDAQ instrument to an existing network, you should check with your Network Administrator before using the default IP address or assigning a new IP address to a NetDAQ instrument or PC.

When assigning the IP address to your PC, unless your network contains a Router, you must use the same Net ID used by the NetDAQ instruments (for example, 198.178.246.*z*). If you do this, you should set *z* to a number that does not interfere with the instruments. Because the BCN can range from 1-99, you should set *z* of the IP address of your PC in the range 101-254. The Subnet Mask assigned to the PC should be 255.255.255.0.

If your network contains more than one subnet, and you want to communicate with a NetDAQ instrument in another subnet, you need to set the default gateway address in both the PC and NetDAQ to the address of the local router. The TCI/IP stack will detect that the destination address for a packet is in a different subnet (via the subnet mask) and send the packet to the default gateway address where the router will route it to the proper subnet.

For example, if you have three NetDAQ instruments with *bcn*'s 1, 2, and 3, and a single PC, you could set the following IP addresses:

NetDAQ #1	198.178.246.1
NetDAQ #2	198.178.246.2
NetDAQ #3	198.178.246.3
Host PC	198.178.246.101

This would place all three instruments and the PC in the same subnet (net ID 198.178.246).

During initial operation of the TCP/IP software the IP section builds a table that contains the correspondence between the IP address and Ethernet address of each host. This is done via the Address Resolution Protocol (ARP). To do this, the IP

software sends out a broadcast frame that every TCP/IP host and router receives. This frame contains a request for the host with the unknown IP address to return a frame to the ARP requester. This response frame contains the Ethernet address of the sourcing host, and this information is then added to the address correspondence table. All communication with a host can then be done with information from the table.

The operation of ARP also initializes the routing tables in bridges, routers, and gateway devices on the net. These tables are used to determine the section of the network to which a frame should be sent.

Ethernet Adapter Hardware for the PC

I-9.

To communicate via the Ethernet network, each PC must be equipped with an Ethernet adapter. There are several types of adapters available (i.e. internal interface boards, Parallel to LAN Adapters (PLAs), and PCMCIA interface cards.) Some PCs are equipped with an Ethernet adapter by the manufacturer, but most adapters must be added after purchase.

Installation of an Ethernet adapter is quite simple. The 264XA-801 card, available as an option to the NetDAQ instruments is supplied with a small software package that investigates the current configuration of the PC and sets the card so there is no interference with other hardware and software. Windows 95 and Windows NT can install commonly used adapters without using the adapter's installation software.

During the installation of an internal interface board on an ISA bus computer, you must make several detailed configuration decisions. An interrupt line (IRQ) is assigned, port addresses selected, and the network connection type selected. Be sure to record these configuration values because you will need them when installing the network interface software (on Windows 3.1).

During installation of a PCMCIA or PLA interface, few, if any decisions need to be made. These devices make use of already established interfaces to the computer bus.

Drivers

I-10.

A driver is the low-level software within the PC that communicates directly with the interface adapter hardware. Drivers cover up the specific nature of the hardware interface and allow the protocol software to be unaware of the type of hardware being used.

Drivers are usually written and supplied by the adapter vendor. Windows 95 and Windows NT supply drivers for commonly used adapters. On Windows 3.1, you may need to install Newt or Trumpet networking software and a driver. The Newt networking software supports two driver standards: ODI and NDIS. The Trumpet network software supports the Packet driver standard.

Packet drivers support only one protocol at a time. As a result, only one package of protocol software can use a packet driver at any one time.

Packet drivers are usually loaded by executing a *.com or an *.exe file in the autoexec.bat. This loads a terminate and stay resident (TSR) program during the DOS boot process. The setup of the packet driver is usually done by including command line switches on the driver load line. There must be at least one switch that assigns the soft interrupt used to communicate with the protocol stack. Other switches may be required to set the IRQ, port address, and other parameters.

For example, the 3Com EtherLink packet driver is loaded by executing the line 3c5x9pd.com 0x60, where the 0x60 sets the soft interrupt to number 60 (hex). This driver needs no other parameters because it reads the other information from flash memory on the interface board. On the other hand, the Cabletron adapter packet driver reads setup information from a file named e21pd.cfg. Since each driver is different, the NetDAQ Logger installation program has packet driver information built-in for only the Ethernet drivers we sell. If other hardware is used, you must enter the proper information in the Trumpet setup window during the installation process or edit the autoexec.bat file directly.

Both ODI and NDIS are multi-protocol, packet driver standards. They both allow operation of more than one set of protocol software "over" the driver at the same time. Use of this feature will be discussed in the protocol section below.

The ODI standard was defined by Novell for use with the netware line of networking software. It supports the native IPX/SPX protocol of netware and other protocols, such as TCP/IP.

NDIS was defined by 3COM and Microsoft for use with the LANManager networking software. It has since become commonly used by other network operating systems. It also supports multiple protocols, including IPX/SPX and TCP/IP.

ODI and NDIS drivers are usually loaded by being included in a DEVICE= line in the config.sys file. This line loads a DOS-level driver. There are a few implementations of the NDIS driver as a Windows VxD level driver. The NDIS driver used with the Windows for Workgroups version of MS Windows is a Windows VxD.

The setup information for NDIS drivers is contained in a file called protocol.ini that must be in the same directory from which the driver is loaded. This file contains sections describing the driver characteristics and the protocols that may be operating over the driver. For example, a driver characteristic section might look like this:

```
[EtherLinkII]
DRIVERNAME=ELNKII$
INTERRUPT=5
TRANCEIVER=INTERNAL
IOADDRESS=0x300
```

While a protocol section might look like the following:

```
[NETMANAGE]
DRIVERNAME=NETMNG$
BINDINGS=EtherLinkII
```

These two `protocol.ini` file sections describe a hardware driver characteristic for a 3COM EtherLink II hardware card and specifies that the NetManage protocol stack should bind with the EtherLink II driver.

The setup information for ODI drivers is contained in a file called `net.cfg` that must be in the Novell directory (the driver must be there too). This file contains sections describing the driver characteristics and the protocols that may be operating over the driver. For example, a driver characteristic section might look like the following:

```
Link Support
    Buffers 8 1589
    MemPool 4096

Protocol IPX
    Bind EXP16ODI

Protocol
    Bind EXP16ODI
    ip_address 198.178.246.101

Link Driver EXP16ODI
    Port 300
    Frame Ethernet_802.3
    Frame Ethernet_II
    Protocol IPX Ethernet_802.3
```

This `net.cfg` file describes a hardware driver characteristic for an Intel EtherExpress 16C hardware card and specifies that the IPX and TCP/IP protocol stacks should bind with the EtherExpress driver.

TCP/IP Protocol Stack

I-11.

A protocol stack is a group of interacting programs that implement the various functions of the network communication protocol. They are usually arranged in a hierarchy of low to higher level functions, so the collection is called a *stack*.

Windows 95 and Windows NT supply a TCP/IP protocol stack and you can obtain TCP/IP software for Windows for Workgroups from Microsoft. On Windows 3.1, you may need to install Newt or Trumpet. Novell sells an optional package for NetWare called LAN Workplace for DOS/Windows that includes a TCP/IP stack.

Currently, the WINSOCK DLL that operates with LAN Workplace must be downloaded from the Novell forum on CompuServe or you must request a copy from Novell. TCP/IP protocol packages with included WINSOCK DLLs can be purchased from a variety of sources including Microsoft, Banyan, FTP, SunSoft, and IBM.

The *Transmission Control Protocol/Internet Protocol* (TCP/IP) has evolved as a networking protocol that supports communication among diverse computers and devices (at U.C. Berkeley there once was a TCP/IP-connected Coke machine). The TCP/IP protocol can be used to communicate between programs running on many different computer systems, running under many different operating systems, and even running on several different physical network types (Ethernet being only one of the many types supported).

The TCP/IP protocol stack is isolated from the underlying network hardware by a device driver. Applications use TCP/IP resources via one of the several Application Programming Interfaces (API) that are commonly supported by network software vendors. The API used by the NetDAQ software is WINSOCK (discussed below). There are also API's for file transfer (FTP) and file sharing (NFS and others).

You rarely need to know the details of the TCP/IP protocol. In summary, TCP/IP enables two computer systems to establish a connection that allows data to be exchanged. Data to be transmitted is broken up into manageable chunks (packets) by the TCP portion of TCP/IP. TCP also reconstructs the data at the receiving end by merging the chunks back together in the correct order. TCP also assures error-free communication by use of a checksum within each packet. Finally, TCP uses the Port ID to specify the specific application within each system that is sending and receiving the data.

The IP portion of the TCP/IP protocol simply addresses, sends, and receives packets. It uses the IP address, the Subnet Mask, and the Default Gateway information. The IP address is described in "IP Addresses and Segmented Networks" in this appendix.

The subnet mask is used to separate the network ID from the host ID in an IP address. For example: if the IP address of a NetDAQ address was 198.178.246.10, and a class C network ID was active, the subnet mask would be 255.255.255.0. When this mask is applied to the address, the network ID is extracted as 198.178.246 and the host ID as 10.

The default gateway information is only used when your network contains more than one subnet, or is connected directly to the Internet. When the network ID of the source and destination address of a packet are different (hosts on different network segments), the packet is forwarded to the default gateway for delivery. The default gateway has knowledge of the network IDs of the other network segments, so it forwards the packet to other gateways on the network until the packet is delivered to the gateway attached to the destination segment with the

matching network ID. This process is generally referred to as *routing the packet*, and devices that do this are also referred to as *Routers or Gateways*.

In many modern networks, the use of subnet masking and the default gateway is not necessary. These networks contain routers and gateways that support the Proxy ARP protocol. In this protocol, the routing path between any two hosts is automatically established by the routers during the ARP process. As a result, the user doesn't need to manually enter the subnet mask and default gateway information.

When the TCP/IP protocol stack software starts operation, it communicates with an NDIS or ODI driver in a process called *Binding*. During this process, the stack tells the driver which protocol it is handling. In this way, a driver can direct packets to more than one protocol stack. For example, it is quite common to have the Novell IPX/SPX protocol stack and the TCP/IP protocol stack operating over the same ODI multi-protocol driver.

The `protocol.ini` file, associated with the NDIS driver and the `net.cfg` file, associated with the ODI driver, contain driver characteristics and information about each protocol that is operating over the driver.

WINSOCK DLL and Application Programming Interface

I-12.

The NetDAQ Logger software uses the TCP/IP protocol via a set of resources contained in a `winsoc.dll`. This DLL contains a set of functions that support two-way communication between two hosts on the network. Of course, both hosts must support the TCP/IP protocol for a WINSOCK connection to be successful.

WINSOCK isolates the NetDAQ application software from the specific implementation of TCP/IP operating in the PC. WINSOCK's interface to applications has been standardized by a committee of many different PC hardware and software vendors. This makes it possible to operate NetDAQ software over WINSOCK's from several different software vendors.

Windows 95 and Windows NT provide a WINSOCK. You can obtain a Winsock for Windows for Workgroups from Microsoft. On Windows 3.1, you may need to install Newt or Trumpet to get a WINSOCK.

Notes to Network Administrators

I-13.

The NetDAQ product line consists of two instruments, the PC software, and some options. The instruments communicate with the PC using the TCP/IP protocol and the Ethernet physical network. Using proper Gateway devices, the PC could be on almost any physical network that is capable of carrying or tunneling TCP/IP packets and can gate to an Ethernet.

NetDAQ instruments support user entry of the subnet mask and the default gateway. On networks that contain routers and gateways and support the Proxy

ARP protocol or have static routing tables, you don't have to use these parameters. In the Proxy ARP protocol, the routing path between any two hosts is automatically established by the routers during the ARP process.

The NetDAQ PC software communicates with the NetDAQ instruments in a totally peer-to-peer manner. Operation of the instruments and software require no server support. As a result, as long as your network can carry and route TCP/IP packets, you should have no interaction between communication with the NetDAQ instruments and other traffic on the network.

The PC software runs in the MS Windows environment and is designed to operate over any `winsoc.dll` that supports version 1.1 of the WINSOCK standard. A 16-bit WINSOCK and TCP/IP software package (Trumpet) is included with the PC software. However, if your PCs already have a `winsoc.dll` and TCP/IP stack loaded, you should use that instead. Especially in Novell environments, you may want to use the "LAN Workplace for DOS & Windows" product from Novell instead of the WINSOCK and stack supplied with the NetDAQ Logger software.

Whichever `winsoc.dll` that you use, make sure that there's only one file with this name in any directory specified in your PATH. WINSOCK libraries are specifically matched to the underlying TCP/IP software and are not interchangeable between software vendors. If the wrong `winsoc.dll` is found during NetDAQ Logger startup, it will be loaded and the network interface will not operate.

The NetDAQ instruments have both coaxial (10Base2) and unshielded twisted pair (10BaseT) connectors for network connection. Only one of these may be connected to a network at any one time because network activity on the connection is used to automatically select which is to be active.

If you are already using the TCP/IP protocol for client/server activities on your network, you may want to review the socket port assignment for the NetDAQ instruments and PC software. If you already have a service assigned to the socket port that is used as the default in the NetDAQ products, you may have to change the port used by NetDAQ. The list of supported services is usually in the "SERVICES" file in the directory that contains the TCP/IP stack software. Changing the socket port used by NetDAQ is easy to do (see Chapters 2 and 3 of this manual for details).

Again, if you are already using TCP/IP, you must assign IP addresses to the instruments (and PCs of course) in accordance with your established subnet scheme. If you install the NetDAQ Logger software for "general network" operation, you are free to select any IP address for the PC and instruments. With the isolated network operation, you are limited to using the 198.178.246.0 subnet (Class C subnet assigned to the Fluke Corporation) for both the PC and instruments.

If your network contains routers, bridges, gateways, or other devices that divide the network into subnets, and you intend to have the PC on a different subnet from the NetDAQ instrument(s), you need to make sure that the devices can route IP packets. This is especially true on Novell networks, where the network may contain devices that can route only IPX packets.

The PC software uses the Address Resolution Protocol (ARP) to establish the relationship between the physical address and IP address of the NetDAQ instruments. The ARP protocol uses broadcast messages. So, your routers must be set up to pass ARP broadcasts to all subnets containing NetDAQ instruments.

Running Two Network Cards in a PC

I-14.

There are cases when you may want to operate more than one network interface on your PC. You can do this if you're careful in setting up the adapters and configuring the software.

One instance when you might want to use two adapters in your PC is when you want to communicate with the NetDAQ instruments on a network that is separate from your general, multipurpose network. Another is when your general network uses other than Ethernet hardware (such as Token Ring).

Use of two network adapters will allow higher throughput when communicating at high speed with a set of NetDAQ instruments on one network and logging data to a file server over the other network.

When setting up two network adapters in a single PC, make sure that the hardware resource setups do not overlap. Each adapter needs a unique interrupt level (IRQ) and port address. This is sometimes hard to do because of the limited number of IRQ levels available in the PC hardware, so be careful.

If you're using two Parallel-to-LAN Adapter Ethernet interfaces (264XA-802), you should include the LPTn switch on the packet driver load line, in the driver section of the `protocol.ini` file for the NDIS driver, or in the driver section of the `net.cfg` file for the ODI driver. This switch specifies which of the parallel ports that adapter is connected to. If you leave this switch off, the driver may attach to the wrong adapter.

If you're using two ISA bus Ethernet adapter cards, make sure that the IRQ level and port addresses don't overlap. Also make sure that you add the I/O address to the end of the packet driver load line, in the driver section of the `protocol.ini` file for the NDIS driver, or in the driver section of the `net.cfg` file for the ODI driver.

Load the network operating system client software first, then load the Trumpet or Newt software.

During installation of the Newt software, be careful to enter the IRQ and port address that matches the network card attached to the NetDAQ instruments.

Network drivers typically use PC soft interrupts to communicate with the protocol software. If you're using two network cards, and as a result, two drivers, you must select two different soft interrupt levels for the drivers. For example, Packet drivers (used with Trumpet) usually use soft interrupt level 60 (hex). If two packet drivers are resident, one can use 60, but the other must use something else (like 61). Usually, this must be communicated to the driver (via a command line switch or configuration file) and to the level of protocol software that is communicating with the driver (winpkt in the case of Trumpet).

So, you usually have to include a command line switch on both the driver load line and on some other load line (like the winpkt line) to identify the soft interrupt and these must match each other. Packet drivers may use soft interrupts in the range 60 - 7F (hex).

Troubleshooting Information

I-15.

This section presents some information about what to do if you cannot successfully communicate between your PC and NetDAQ instruments.

1. Mouse stops working when using a Parallel-to-LAN adapter (PLA).

This is usually due to a bus mouse using the same IRQ as the PLA's parallel port. Move the bus mouse to a different IRQ.

2. Bind fails during PC boot.

Check that the information in the driver section of the `protocol.ini` file associated with the NDIS driver, matches the setup of the Ethernet adapter.

Check for misspelled words in the `protocol.ini` file (NDIS driver). Make sure that the `BINDINGS=` line in the `[NETMANAGE]` section contains the name of the correct driver section.

Check that the soft interrupt specified for use by the network interface driver is the same as specified for use by the protocol software. Make sure that this interrupt is not being used by another software package (i.e. another hardware driver).

3. Network software loads and binds properly, but NetDAQ Logger cannot communicate with the instrument.

Use the communication configuration dialog and the instrument front panel interface to check that the Base Channel Number (BCN), IP address, Socket Port Number, and Instrument Type are all correct for each instrument.

If General Networking mode is selected, check that the subnet of the PC is the same as the subnet of each instrument (see "IP Addresses and Segmented Networks" in this appendix). If the subnets are not the same, check the router connecting the subnets to make sure it can route IP packets. Also check the

NetDAQ instrument and the PC default gateway addresses to make sure they are set correctly.

Check all network wiring. Make sure that 10Base2 terminators are placed at the two open ends of the coax. Make sure that there is no more than one terminator on each end (some network repeaters, bridges, and routers have termination built into the unit.)

In a 10Base2 network, make sure that the collision indicator on the instruments (amber LED) is not lighting. If the collision indicator lights often, check all wiring for possible sources of impedance mismatch, missing terminators, broken insulation, metal parts touching each other (i.e. the Tee touching another connector on the PC), or other wiring problems.

In a 10BaseT network, make sure that the link indicator (same amber LED) is lit continuously. If it is not, make sure that connection to the hub is correct and that the hub port is active.

If you have replaced an instrument with another with the same IP address (same BCN in the isolated network mode), you must reboot your PC. The TCP/IP software builds a table of the relationship between an instrument's IP address and its Ethernet address. If you attach a new instrument to the network with an IP address that has been previously used, the relationship between the IP and Ethernet address will be wrong, causing communication with that instrument to fail. Rebooting the PC clears the IP/Ethernet address relationship table (the ARP table).

Make sure that there is only one TCP/IP stack software package running on this PC.

4. Instrument to PC communication starts OK, but there are frequent communication interruptions reported.

On a general network that is heavily loaded or if there are lots of routers or gateways between the host and the instrument, the communication time-out value may need to be increased. Edit the CommTimeout parameter in the `netdaq.ini` file (value is seconds) to increase the timeout up to 1000 seconds.

There may be times on a very heavily loaded general network where it is impossible to maintain high enough speed communication with the instrument to avoid communication interruptions. In this case, consider moving the instrument to an isolated network or a different subnet.

5. NetDAQ Logger can not keep up with the scan rate selected in the instruments. This is indicated by the count of the number of scans in the instrument increasing continually, to the maximum count, during a data acquisition run. Once the maximum count is reached, an error message is displayed by the NetDAQ Logger software indicating that scans are being lost.

Move your instrument to a less loaded subnet of your network or isolate the NetDAQ instruments on their own network.

If possible, increase the scan interval.

Use the Fast Binary file format rather than CSV or Trend Link formats.

Make sure that there are few or no other Windows applications running at the same time as NetDAQ Logger.

Upgrade to a faster PC and disk drive and increase the amount of RAM in your PC.

Disable the Windows Screen Saver function or make sure that it doesn't activate during data collection.

Turn off Trend Link, QuickPlot, and Spy in NetDAQ Logger and don't open any dialog boxes in NetDAQ Logger.

Close any dialog boxes that you have open in NetDAQ Logger. Avoid operations which open dialog boxes, such as configuring an instrument, while logging data at high speed.

Load smartdrive during PC boot or use vcache with Windows for Workgroups. Use of disk caching utilities increases throughput to the data files. However, data could be lost if the PC crashed suddenly due to power failure or malfunction.

Make sure the disk drive that you're writing the data files to is not fragmented. Disk fragmentation develops during a long period of writing and deleting files on the disk. Use a defragmentation utility (like Norton speedisk) to reduce this problem.

If you're using a general network that is loaded by other communication, isolate your instruments and host computer onto separate wiring and a separate host computer interface adapter from general network communication. If you must still communicate via the general network, consider installing two network adapters in your host computer and communicate only with NetDAQ instruments on one adapter and wiring (see "Running Two Network Cards in a PC" in this appendix).

6. Interaction with advanced display adapter driver packages.

A very common software interaction exists between network support software and advanced display adapter driver and support packages. If your network software doesn't load or operate properly, try selecting the standard VGA driver in Windows Setup under the control panel. If the problems go away, contact your display adapter vendor for the latest version of their display adapter driver and associated support software. If using the latest version doesn't fix the problems, you may have to use a less capable display adapter driver package when running the NetDAQ and other networking software.

7. Failure to communicate when using the Parallel to LAN Adapter (PLA)

In some computers the speed of the parallel port hardware is insufficient to support the normal bi-directional communication used by the Silicom PLA. In these rare cases, you must force use of the uni-directional communication on this interface. You do this by adding the `unidir` switch to the driver.

If you are using the Trumpet TCP/IP package (isolated network), you place the `unidir` switch on the command line in your `autoexec.bat` file where the `etpacket.com` packet driver is loaded as follows:

The line in the `autoexec.bat` before the change:

```
c:\netdaq\etpacket.com int:60
```

The line in the `autoexec.bat` after the change:

```
c:\netdaq\etpacket.com int:60 unidir
```

If you are using the Newt TCP/IP package (General Network), you place the `unidir` switch on a line in the driver information area of the `protocol.ini` file (NDIS driver) as follows:

The lines in the `protocol.ini` file before the change:

```
[silicom]  
drivername=epndis$
```

The lines in the `protocol.ini` file after the change:

```
[silicom]  
drivername=epndis$  
unidir
```

For further information on the `unidir` switch, see the Silicom SET User Guide.

8. Newt loads without error on a Novell work station, but cannot communicate with NetDAQ instrument.

Be sure that there is only one `net.cfg` file, or that the one modified by the newt installation program is also loaded by the Novell station.

Handling Token Ring Networks

I-16.

If you need to install your NetDAQ system on an existing token ring network, your network must contain a Gateway device (see “Network Interconnection Devices” in this appendix). The Gateway must support both Ethernet and Token Ring subnets, and must be capable of routing IP packets between these two subnets. You will need to consult with your Network Administrator about setting up the routing tables in the Ethernet to Token Ring Gateway device to allow proper routing of IP packets.

If you install Newt networking software on a token ring network on Windows 3.1, the Newt installation procedure must be modified slightly. When prompted for the interface type in the “Add Interface” dialog box, use the list pull-down control to display the other types. From the type list, select “Token Ring”, then hit the OK button on the dialog box.

Continuing with the Newt setup, when the hardware selection dialog is presented, you will see only Token Ring network adapters in the list. Select your adapter or select “Other” for hardware that is not on the list. If you choose other, you need to enter information from the hardware vendor documentation in the Section Name and Driver Name fields in the hardware setup dialog box. You will also be asked to enter the file name of the driver. Consult the Newt documentation for more information on this.

Once hardware setup is complete, continue the installation.

Newt Networking Software

I-17.

If you are running Windows 3.1 and do not already have a TCP/IP protocol stack, you can purchase and install Newt Networking Software, option 2640A-913. Read the following sections to decide whether you need the Newt software, then use the installation instructions later in this appendix. Before installing Newt software, review the following checklist to make sure your network is ready for this installation.

Ethernet Adapter For most general networks, an Ethernet adapter will already have been installed on the host computer. If this is not the case, one of the recommended Ethernet adapters for your host computer may be purchased from Fluke as an option. See “Installing the Host Computer Ethernet Adapter” before proceeding with the Newt software installation.

Driver for Ethernet Adapter If you intend to interoperate (communicate over the same Ethernet adapter hardware and wiring) with your existing network software, and this software (including Ethernet adapter driver) is already installed and operating, one of the following conditions must be met:

- An NDIS or ODI driver is already installed and configured to support the existing network but a TCP/IP stack is not installed.
- A driver other than an NDIS or ODI driver is used by the existing network software. In this case, you will need to upgrade your networking software to accommodate an NDIS or ODI driver. Consult your local network administrator or your network software vendor for information on this upgrade. Once the NDIS or ODI driver is in use, the Newt software can be installed.
- If your Ethernet adapter is newly installed, run the manufacturer’s installation program to install the NDIS and/or ODI drivers.

Ethernet Components and Wiring The NetDAQ instruments and host computer should be connected to the network as shown in Chapter 2 of this manual.

Instrument Preparation Each NetDAQ instrument should be connected to an ac outlet or dc source with a proper ground. The instrument's line frequency and network parameters should be set properly (see "Instrument Preparation" in Chapter 2 of this manual).

General Network Parameters Before you begin software installation, obtain the parameters needed to complete the items listed below. These parameters are available from your network administrator, network software vendor, or Ethernet adapter documentation. The default gateway parameters are only needed if your network contains router or gateway devices. The Ethernet adapter parameters are needed only if this hardware is not in the list of devices supported by the Newt installation program. The socket port number is needed only if the default socket port number (4369) is currently in use on your network.

If your host computer is already running network software in the Windows 3.1 or 3.11 environment using a separate adapter and isolated network wiring, make sure that the two Ethernet adapters do not interfere with each other. Consult the documentation that came with your Ethernet adapter and see and see "Running Two Network Cards in a PC" in this appendix for information on installing two network adapters on one host computer.

Newt TCP/IP vs. Novell NetWare

I-18.

If you have the Novell TCP/IP package (LAN Workplace for DOS/Windows) with WINSOCK already installed on your PC, you do not need to install the Newt package. You do, however, need to get the `winsoc.dll` associated with the LAN Workplace product from Novell. This is available by down-load from CompuServe or from the Novell BBS.

If you don't have the Novell TCP/IP package, use the Newt package with the basic NetWare client software on your PC. First, boot your PC with your Novell NetWare Client software active. Make sure that the version of NetWare you have uses an ODI driver.

Next, use the basic Newt installation procedure in this appendix. Newt Setup will detect the presence of the Novell NetWare software and automatically modify the NetWare `net.cfg` file. If Newt Setup cannot find the active `net.cfg` file, it will prompt you for its location.

Novell NetWare uses an ODI driver, loaded during your Novell client code setup. The Newt TCP/IP stack will be loaded to operate over this driver.

On completion of Newt installation, you will see that the `net.cfg` file in the Novell NetWare directory has had something like the following lines added (example for the Intel EtherExpress 16C adapter).

```

Link Driver EXP16ODI
Port 300
Frame Ethernet_802.3
Frame Ethernet_II
Protocol IPX 0 Ethernet_802.3

```

Newt TCP/IP vs. Microsoft LANManager

I-19.

If you have the Microsoft LANManager software already installed on your PC, you do not need to install a new driver. However, unless you have the LANManager TCP/IP software option, you will need to install the Newt TCP/IP stack.

During NetManage Newt installation, select *None* when asked for a hardware Vendor.

LANManager uses an NDIS driver that is loaded during installation of this software. To add NetManage TCP/IP support to this driver, you must add lines to the `config.sys` and `protocol.ini` files. Add a line to the `config.sys` just after the line where the NDIS network driver is loaded as follows:

```
DEVICE=c:\netmanag\netmanag.dos
```

Add a section to the `protocol.ini` file as follows

```
[NETMANAGE]
```

```
DRIVERNAME=NETMNG$
```

```
BINDINGS=hardware driver name
```

The *hardware driver name* should be the same as that used in the drivers section of the `protocol.ini` file (section that identifies the hardware used).

Delete the following line from your `autoexec.bat` file (the Newt Setup program placed it there):

```
c:\netmanag\netbind
```

If you already have the LANManager TCP/IP software package installed, you do not need to install the Newt package. Just make sure that the directory containing the `winsock.dll` file is in the path as specified in your `autoexec.bat`.

Newt TCP/IP vs. Banyan Vines

I-20.

Banyan Vines versions 4.10, 4.11, and 5.5 or higher can use the NDIS driver for network card support. You must configure Vines to use the NDIS driver in order to install the Newt software. This is done via the Banyan PCCONFIG utility supplied with Vines.

After configuring Vines for NDIS driver support, install Newt. Select "None" when asked for a hardware Vendor.

Once Newt is installed, edit the `protocol.ini` file in the Vines directory to add the following section:

```
[NETMANAGE]
DRIVERNAME=NETMNG$
BINDINGS=hardware driver name
```

The *hardware driver name* should be the same as that used in the drivers section of the `protocol.ini` file (section that identifies the hardware used).

Add a line to the `config.sys` just after the line where the NDIS network driver is loaded as follows:

```
device=c:\netmanag\netmanag.dos
```

Delete the following line from your `autoexec.bat` file (the Newt Setup program placed it there):

```
c:\netmanag\netbind
```

At present, the Banyan TCP/IP software package doesn't support `winsock.dll`. Since this is needed to run NetDAQ Logger, you must replace the Banyan TCP/IP package with Newt.

Newt TCP/IP vs. Windows for Workgroups

I-21.

Microsoft Windows for Workgroups contains built-in peer to peer networking capability. This capability normally uses the Microsoft Network Protocol (combination of NetBIOS and NetBEUI), but can operate over TCP/IP or other protocols. You can also run Newt TCP/IP and the Microsoft Network Protocol at the same time on a PC because Windows for Workgroups normally uses NDIS drivers that are capable of supporting more than one protocol.

If you already have the TCP/IP for Windows for Workgroups optional software package from Microsoft, you do not need to install Newt. Just install NetDAQ Logger. It will use the `winsock.dll` included in your TCP/IP package.

We recommend that you upgrade to Windows for Workgroups Version 3.11 before attempting to install Newt and NetDAQ Logger. You should also have Windows for Workgroups configured and operating with networking enabled before starting Newt installation.

After ensuring that the proper version of Windows for Workgroups is installed and working properly, install Newt. Select "None" when asked for a hardware Vendor. Aside from that, install Newt in the same way as described above.

Newt will modify the following files:

- **autoexec.bat** Netmanage directory added to the path.
- **system.ini** netmanage.dos added to the transport= line under the [Network Drivers] section. LoadRMDrivers= will be changed to Yes.
- **protocol.ini** [NETMANAGE] section added that should have a BINDINGS= line that links to the adapter driver that is to be used for the interface to the NetDAQ instruments.

Once Newt is properly installed, search the Windows directory for a file named `winsock.dll`. If you find this file, you must remove it or rename it so the Newt `winsock.dll` is used instead of the one that came with Windows for Workgroups.

Newt TCP/IP vs. Windows for Workgroups and Novell NetWare I-22.

If you're running Novell NetWare Client functions in Windows for Workgroups, the Installation will be somewhat different.

Make sure that Windows for Workgroups with Novell Client functions is operating properly before installing Newt. If this is the case, your `autoexec.bat` will load an ODI driver and the `odihlp.exe` shim rather than the usual NDIS driver.

After ensuring that Windows for Workgroups and Novell NetWare are operating properly, install Newt as described above. You will not be prompted for hardware setup, because the Newt setup will sense that an ODI driver is already active.

Newt will modify the `net.cfg` file to add the necessary Frame and Protocol lines to support TCP/IP as an active protocol over the ODI driver. It will also add a load of the NMODI shim to your `autoexec.bat` file to allow the Newt stack to operate over the ODI driver.

Installing Newt Networking Software I-23.

Complete the following procedure to install Newt:

1. Insert Newt disk 1 and run `setup.exe`.
2. Follow the Newt setup instructions:
 - a. Enter the Serial Number and Key Number from the NetManage License Record Card. Use UPPERCASE for alpha characters. Click Continue.
 - b. If you are *not* prompted for the Identification information above, then you have residual elements of a previous Newt installation on your host computer.
 - c. If you do not intend to update the current Newt installation, do not continue with this procedure.

- d. Accept the default directory `c:\netmanag`. Click Continue.
- e. Acknowledge the Setup is Complete! message by clicking OK.
3. Select Interface | Add. Accept the Ethernet defaults. Click OK.

If you are already using Novell NetWare Client software, Banyan Vines, Windows for Workgroups (with networking enabled) or another package that already has installed an ODI or NDIS driver, the following Hardware Selection dialog box will not appear and the existing driver is used. Newt modifies the `protocol.ini` (NDIS driver) or `net.cfg` (ODI driver) file associated with the installed driver.
4. Select Setup | Hardware. Select the desired Ethernet adapter hardware type. If your hardware device is not shown, select Other and enter the Section Name, Driver name, and the Driver File name and location in the appropriate fields (Entries in this box are case-sensitive.) Refer to the *Newt Manual* for more information.
5. Select Setup | IP address. Enter the IP address assigned by your network administrator for this host computer and click OK.

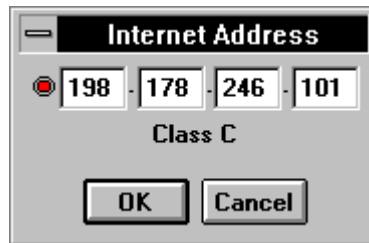

6. Select Setup | Subnet Mask. Accept the default of zero additional mask bits unless your system administrator says otherwise. A subnet mask other than the default for your IP address is required if routers are used on your network to divide the net into "subnets.



7. Select Setup | Host Name. Enter the host name assigned by your network administrator for this host computer. Click OK.
8. Select Setup | Domain Name. Enter the domain name assigned by your network administrator for this host computer. Click OK.
9. Select Setup | Ethernet Type and verify that Ethernet/DIX is selected. Click OK.



10. Check the Custom window for a summary of your parameters (the example below is typical). Repeat Steps 4 to 9 as required to make changes. The Physical Address (host computer Ethernet Adapter interface address) is entered automatically when the computer is rebooted.

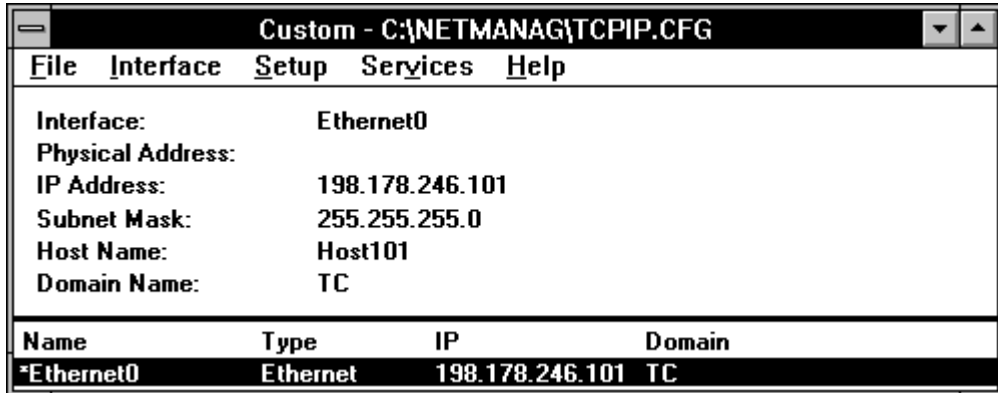

11. Select File | Save. If the NDIS driver must be loaded, and it cannot be found on one of the directories specified in your PATH environment variable, the following dialog box displays. Enter the path to the NDIS driver. It is usually found in the NDIS directory of the diskette supplied with your Ethernet adapter.

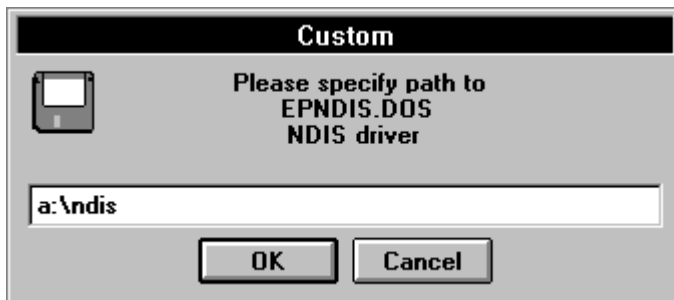

If communication between the host computer and a NetDAQ instrument must pass through a router or gateway, you must set up the default gateway address on both the host computer and the instrument. (This information is available from your network administrator.) To set the default gateway address in Newt, select Service | Default Gateway and enter the address for your local router or gateway.

12. In the Custom window, select File | Exit. Click OK to reboot the computer. After rebooting is complete, continue to Step 13.
13. In Windows, open Custom from the NEWT group. Verify that the Physical Address is filled in (the example below is typical). If you receive error messages, see Table I-1 Newt Quick Check.

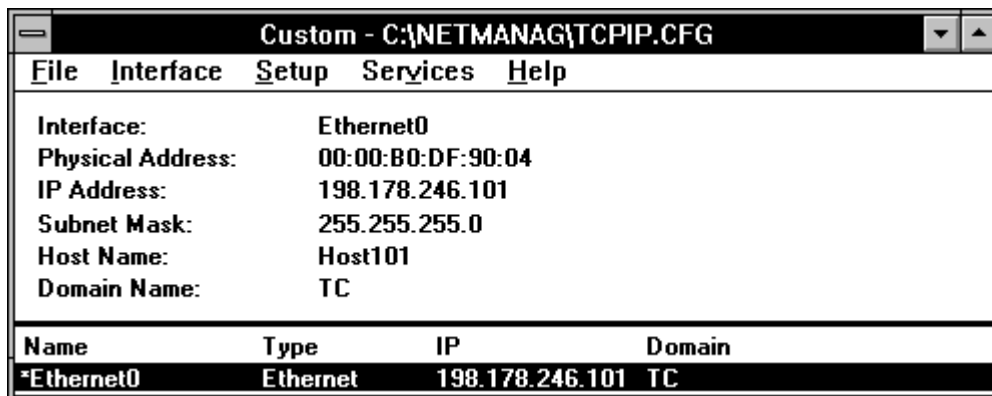

Write down the Physical (Ethernet) Address from the Custom window inside the back cover of this manual. Select File | Exit to close Newt.

Table I-1. Newt Quick Check

Newt Error Messages	Description of Problems and Problem Resolution
Plug-in Card	
Failed to get interface characteristics table	1. No Ethernet card is installed. Complete "Installing the Host Computer Ethernet Adapter" in Chapter 2 of this manual.
Failed to initialize interface	2. The installed Ethernet card does not match the Newt Custom Hardware selection. Change hardware selection. See Step 4 of the Newt installation procedure.
	3. Newt was installed but the computer was not rebooted to implement the changes to the autoexec.bat and config.sys files. Reboot the computer.
Failed to open driver	4. The Ethernet card I/O Base Address given in step 5 is incorrect.
Parallel-to-LAN	
Failed to get interface characteristics table	1. No Ethernet adapter or the adapter is not powered. Check that the Ethernet Adapter power LED (red) is on.
	2. The installed Ethernet Adapter does not match the Newt Custom Hardware selection. See Step 4 of the Newt installation procedure.
Failed to initialize interface	3. Newt was installed but the computer was not rebooted to implement the changes to the autoexec.bat and config.sys files. Reboot the computer.
	4. There is an IRQ5 or IRQ7 (Interrupt Request) conflict with your parallel port. For example, you may be sharing the IRQ with a bus mouse (a mouse not connected to a COM port). In DOS, use the MSD utility (supplied with Windows) to examine your computer setup and make corrections as required, or use a different parallel port.
Failed to open driver	5. Errors in autoexec.bat, config.sys, or win.ini. See Table I-2 for the correct listings. Use the Notepad accessory to check each file and make corrections.

Table I-2. Additions to Host Computer Files made by Newt Installation

Newt Installation	Host Computer Files Addition or Modification
<p>Newt for a typical plug-in Ethernet card</p>	<p>Five lines added to c:\autoexec.bat</p> <pre>@REM The following line was added by Chameleon (date) C:\NETMANAG\NETBIND C:\NETMANAG; (to the PATH command) @REM The following line was added by Chameleon (date) SHARE</pre> <p>Six lines added to c:\config.sys</p> <pre>REM The following line was added by Chameleon (date) DEVICE=C:\NETMANAG\PROTMAN.DOS /I:C:\NETMANAG REM The following line was added by Chameleon (date) DEVICE=C:\NETMANAG\ELNK3.DOS REM The following line was added by Chameleon (date) DEVICE=C:\NETMANAG\NETMANAG.DOS</pre> <p>Four lines added to c:\windows\win.ini</p> <pre>[TCPIP] ID=M4py50snByr0sl_Srhf (typical) SLIP=C:\NETMANAG\SLIP.INI FILE=C:\NETMANAG\TCPIP.EFG</pre> <p>Directory added: C:\NETMANAG</p> <p>Group added to Program Manager: NEWT</p>
<p>Newt for a typical Parallel-to-LAN Ethernet Adapter</p>	<p>Two lines added to c:\autoexec.bat</p> <pre>C:\NETMANAG; (to the PATH command) C:\NETMANAG\NETBIND</pre> <p>Three lines added to c:\config.sys</p> <pre>DEVICE=C:\NETMANG\PROTMAN.DOS/I:C:\NETMANAG DEVICE=C:\NETMANG\EPNDIS.DOS DEVICE=C:\NETMANAG\NETMANAG.DOS</pre> <p>Four lines added to c:\windows\win.ini</p> <pre>[TCPIP] ID=m4py50snByr0sl_Srhf (typical) SLIP=C:\NETMANAG\SLIP.INI FILE=C:\NETMANAG\TCPIP.CFG</pre> <p>Directory added: c:\netmang</p> <p>Group added to the Program Manager: NEWT</p>

Glossary

I-24.

10Base2 Network wiring scheme using 50 ohm coaxial cable (10 MHz, Baseband, 200 meter max. length).

10BaseT Also called UTP. Network wiring scheme using unshielded, twisted pair cable (10 MHz, Baseband, Twisted Pair).

API Application Programming Interface. A documented interface that allows application software packages to access resources from a library. For example, WINSOCK is an API into the `winsock.dll` library, which itself gives users access to functions in the TCP/IP protocol stack software. Other commonly used APIs are the Windows SDK, OLE, NetBIOS, and DPML.

ARP Address Resolution Protocol. A low-level portion of the TCP/IP protocol that automatically determines the relationship between a host's IP address and its physical address. For example, on an Ethernet, the ARP table contains the relationship between a host's IP address and Ethernet address.

BCN Base Channel Number. Used by the NetDAQ instruments and software to identify the channel number range assigned to a specific instrument. Set from the front panel controls on the instrument. Also used in the isolated network mode to set the lowest order portion of the IP address assigned to the instrument (198.178.246.BCN).

Bind The process of initializing the interface between the physical interface driver (device driver) and the bottom of the TCP/IP stack software. During the bind process the information in the `protocol.ini` (NDIS Driver) or `net.cfg` (ODI Driver) is communicated to the driver and the protocol software.

Bridge A device used to isolate two portions of a network on the Frame level. Used to minimize collisions on an Ethernet. Also acts as a repeater.

Brouter A device that combines bridge and router functions in the same box.

Client A computer system that uses resources made available by other computers on a network.

Default Gateway Address The address of the router or gateway that routes packets from the local subnet to other subnets in the network. If a host determines that the destination address for a packet has a different subnet number than its own subnet (via use of the subnet mask), it sends the packet to the default gateway to be routed to the correct subnet.

Dialog Box A standard MS Windows user interface mechanism that consists of a window containing various controls (input fields, check boxes, radio buttons, etc.)

DLL Dynamic Link Library. A library loaded automatically by MS Windows when required by an application software package and unloaded when it is no longer needed.

DNS Domain Name Service. A database and associated software packages that provides the means of establishing and accessing the relationship between the names and IP addresses of network hosts.

Domain A group of computers on the network may be assigned a domain name and referred to by that name. Domain names can be used as part of the Internet name of a host. For example, my Internet name is dag@tc.fluke.com. My domain name is “tc”.

DOS An operating system used on the IBM PC and clones of this architecture. There are three major variations of DOS (and lots of minor ones): MS/DOS from Microsoft, PC/DOS from IBM, and DR/DOS from Novell.

Driver A software package that provides a specific and usually standardized interface between a hardware interface and application software. There are three standard network driver types; NDIS, ODI, and Packet.

Ethernet One type of physical network standardized by IEEE-802.3. The Ethernet standard supports several wiring types.

Ethernet Address An Ethernet address is a six-part number. It is usually expressed in hexadecimal format, with each part separated by a colon. This address must be unique and is usually assigned to a hardware interface device at the point of manufacture.

Frame A sequence of bits on a physical net that encompasses one block of communication between a transmitter and one or more receiver. A frame usually contains a header, source and destination physical addresses, an error detection field, and the information that is to be transferred. In TCP/IP over Ethernet, the Ethernet frame contains the IP packet, which, in turn contains the TCP packet.

Gate Also called a Gateway. A device used to interconnect different types of physical networks. Gateways also usually perform router functions.

Host Any computer system attached to a network.

Hub The central unit of a 10BaseT network. It is a hardware device that allows multiple hosts to communicate with each other via 10BaseT cable. Most hub devices also support gating 10BaseT wiring to other forms of network wiring.

Interrupt A scheme for signaling the CPU in a computer that an event has happened that needs software service. In the IBM PC there are two types of interrupts. The first are IRQs (or hardware interrupts) that are communicated via signals on hardware connections to an interrupt controller on the PC motherboard. The second are soft interrupts that allow one software package to signal another that some event has happened. Soft interrupts are initiated by executing a CPU instruction. In the PC/AT architecture, there are 16 IRQs and 256 soft interrupt levels available.

IP A unit of information passed across an Internet. The IP portion of the TCP/IP protocol is responsible for transmitting blocks of data from the source to the destination using the IP addresses specified. It also provides for fragmentation and reassembly of data blocks that are too long for one frame on the physical network.

IPX A protocol used by Novell NetWare LANs.

IP Address Internet Protocol Address. A 32-bit address assigned to a host on a TCP/IP Internet. The IP address is divided into Host ID and Network ID portions.

IRQ Hardware interrupt level in the IBM PC standard. The PC/XT supports 8 IRQ levels and the PC/AT supports 16 levels.

LAN Local Area Network. A network that covers a single site, usually at most, a single building or cluster of buildings.

MAC Media Access Control. The lowest layer of network interface hardware and software. Most of the MAC layer is usually implemented in hardware and embedded software in the network interface hardware. Some of the functionality of the MAC layer may be in the driver for the interface hardware.

Network A system of computers interconnected by wires or other means in order to share information.

Network Interface Adapter A hardware device that allows a computer to communicate with a network. Modern network adapters contain on-board logic that implements most of the MAC layer of the network protocol.

NetDAQ A trademarked name for a series of really fine instruments, software, and accessories from the Fluke Corporation. Stands for *Networked Data Acquisition*.

NDIS Driver Network Device Interface Specification. One of the three popular device driver specifications used on Personal Computers. NDIS supports operation of multiple protocol stacks over the same driver and hardware interface.

NIC Network Information Center. The central agency for IP address assignment to organizations. You must get an IP address range assignment from the NIC before connecting to the international Internet.

ODI Driver A network device driver specification defined by Novell for use with the NetWare line of networking software. ODI supports operation of multiple protocol stacks over the same driver and hardware interface.

Packet A block of digital data on a network, usually containing source and destination addresses, protocol type information, and other information that allows it to be directed to the proper destination and for the receiving host to detect transmission errors.

Packet Driver A network device driver specification defined by 3COM. Packet drivers support operation of only a single protocol stack over the driver and hardware interface.

PC Personal Computer. A much misused term usually used to refer to a computer built to comply with the IBM PC defacto standards. Also used to refer to just about any small computer.

PC Port Address The Intel X86 processor architecture supports addressing of I/O devices in a separate address space from memory. The PC/AT architecture supports 1024 of these I/O device addresses, commonly called port addresses. In most cases, each I/O device (including network adapter cards) are assigned one or more port addresses to allow the software to communicate with the interface hardware.

PING Packet Internet Groper. A program for testing if a host with a specified IP address or name is reachable on the net. Some PING programs report statistics about the path to the host that is found.

PLA Parallel to LAN adapter. A network interface adapter device that plugs into the standard parallel interface (Printer Port) of an IBM PC or clone.

Port Also called an application port or socket port. A number used to identify a specific connection to an application using TCP services. TCP uses port numbers to provide multiple connections between applications in one host and applications in one or more other host.

Proxy ARP A protocol used by Routers and Gateways to establish inter-subnet routine paths automatically during the execution of an ARP between two hosts.

Network Protocol A standard procedure for regulating data transmission between computers.

net.cfg A file in a standard format used to hold configuration information for an ODI driver.

Protocol Stack A group of software packages that work together to implement a network protocol. These packages are usually arranged so that one package communicates with at most two other packages, one that implements a lower level of the protocol and one at a higher level. This is why the collection is called a "Stack".

protocol.ini A file with a standard format used to hold configuration information for NDIS drivers.

Repeater A device used to physically isolate and extend the length of a network wiring segment.

RFC Request For Comment. RFC documents describe all aspects and issues associated with the International Internet and the TCP/IP protocol. Whenever a

change to TCP/IP is contemplated, an RFC is issued over the Internet and everyone is invited to comment on the change before its implementation.

Router A router provides a communication path between two or more sections of a network. It directs packets between sections (subnets) of the network so that only those packets addressed to hosts (or other routers) within the subnet are communicated to that subnet.

Server A computer that provides services (such as file, print, and database services) to other computers on a network.

Shim A driver-like TSR that translates the interface of a driver of one type to communicate with protocol stacks that expect to communicate with a driver of a different type. In most cases this is a TSR that allows stacks that can operate only over NDIS or ODI drivers to use another type of driver (such as a packet driver).

Socket A two-way pipe-like connection between an application port in one host and an application port in another host. Once a socket is established between two hosts, everything that is placed in the output socket of one host will appear in the input socket of the other host. An API to the socket functions of TCP is provided by WINSOCK.

Subnet A portion of the network that is partially isolated from other sections of the net by a router device. In IP networks, the upper portion of the IP address defines the subnet and the lower portion is unique for each host computer.

Subnet Mask A 32-bit pattern that is used to separate the subnet portion from the host portion of an IP address. This mask is used to determine whether an addressed host is on the local subnet, or if the packet needs to be communicated to a different subnet through a router.

TCP Transmission Control Protocol. The high level portion of the TCP/IP protocol. It is responsible for providing reliable, securable, end-to-end connection service between pairs of processes in hosts on the network. It must provide facilities for:

- Basic Data Transfer
- Reliability (retry, sequence numbering)
- Flow Control (ACK/NACK)
- Multiplexing (socket ports)
- Connections (Sockets)
- Precedence and Security

TSR Terminate and Stay Resident. A DOS program that, when run, leaves a portion of itself resident upon termination.

Token Bus One type of physical network standardized by IEEE-802.4.

Token Ring One type of physical network standardized by IEEE-802.5.

UDP User Datagram Protocol. A portion of the TCP/IP protocol. It supports unreliable, connectionless, datagram services. UDP has much lower overhead (both time and space) than TCP, but is unreliable and should be used only when the application software provides algorithms for reliability, sequencing, flow control, and other such services usually provided by TCP.

UTP Unshielded Twisted Pair also called 10BaseT. A network wiring scheme using twisted pair wiring and connectors that look somewhat like telephone jacks and plugs.

WAN Wide Area Network. A network that supports hosts at locations that are far apart. Usually refers to a network that covers more than one city and can refer to a world-wide network.

Windows An operating environment developed by the Microsoft Corporation. Also the name of a rectangular region on a computer screen containing the user interface for a task or a portion of a task. Each MS Windows application maintains at least one window (even though you can't see some of them).

Appendix J

Error Messages & Exception Conditions

Introduction **J-1.**

This appendix describes error messages and how NetDAQ Logger handles exception conditions during operation.

Communications Connection **J-2.**

If the communications connection to an instrument is broken during logging, a modeless window appears with a warning message, bringing NetDAQ Logger to the top. NetDAQ Logger continues on with other instruments in a round-robin fashion and attempts to regain communication with the disconnected instrument each time around.

Full-Disk **J-3.**

If the disk becomes full during data collection or if the directory structure is deleted such that attempts to write to the data file fail, subsequent scans are not be recorded, but communication with the instrument and data display continues. A modeless window appears with a warning, bringing the NetDAQ Logger application to the top.

Scan Queue Overflows **J-4.**

If the instrument's scan queue overflows, a modeless window appears with a warning message.

Error Conditions **J-5.**

Various error conditions in the instrument are checked and reported at the time communications are opened. Diagnostic messages are displayed if the user enters

invalid values into the fields of a dialog box. If a critical instrument error occurs (RAM constants failure or A/D not responding), a modeless window appears with a warning message. For a description of each error message, refer to Error and Status Messages in the online help.

Error and Status Messages

J-6.

NetDAQ Logger displays three types of messages: Verification, Exclamation, and Information.

Verification messages (below is typical) ask you to verify your operation. Click the Yes or No button. No cancels the operation.

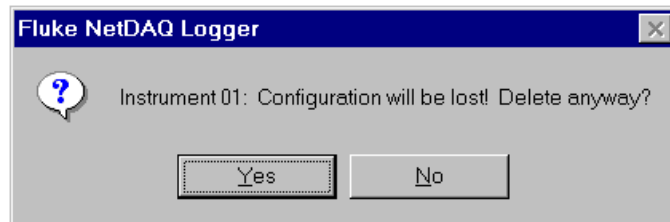

ds309s.bmp

Exclamation messages (below is typical) notify you of an operational error. Click the OK button in acknowledgment.

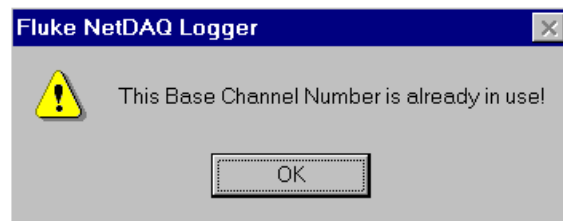

ds310s.bmp

Information messages (the example below is typical) provide information or notify you of a non-allowed operation. Click the OK button in acknowledgment.



ds311s.bmp

Error and status messages are summarized below in alphabetical order. Locate the message and then read the Explanation for more information.

[File Name] is not a valid ASCII file!

You are trying to use an incompatible ASCII file for this conversion. Make sure you are selecting a NetDAQ ASCII (CSV) file. Other CSV formats such as Trend Link cannot be used with the NetDAQ conversion utilities (Utilities menu).

[File Name] is not a valid Binary file!

You are trying to use an incompatible Binary file for this conversion. Make sure you are selecting a NetDAQ Binary (BIN) file. Other BIN formats cannot be used with the NetDAQ conversion utilities (Utilities menu).

4W Measurements not allowed on Channels 11-20!

You tried to configure 4-wire measurements on channels 11 to 20. 4-Wire measurements require two channels spaced a decade apart, e.g., channel 3 and channel 13. The lower channel is configured and the upper channel is prevented from being configured. This means you can configure 4-wire measurements only on channels 1 to 10.

A/D Board Failure! Continue?

Your instrument has detected a fault during internal performance monitoring. This message does not appear under normal operating conditions. Note the message and click Yes to continue operations or No to terminate operations. If the fault recurs, stop operations, and cycle instrument power. If the fault still persists, remove the instrument from service and return it to a Fluke Service Center for repair, along with a description of the error message.

A/D Open Thermocouple Detection Failure! Continue?

Your instrument has detected a fault during internal performance monitoring. This message does not appear under normal operating conditions. Note the message and click Yes to continue operations or No to terminate operations. If this fault occurs again, stop operations and cycle instrument power. If the fault still persists, remove the instrument from service and return it to a Fluke Service Center for repair, along with a description of the error message.

A/D Overload Detection Failure! Continue?

Your instrument has detected a fault during internal performance monitoring. This message does not appear under normal operating conditions. Note the message and click Yes to continue operations or No to terminate operations. If the fault recurs, stop operations, and cycle instrument power. If the fault still persists, remove the instrument from service and return it to a Fluke Service Center for repair, along with a description of the error message.

A/D Reference Balance Values Invalid! Continue?

Your instrument has detected a fault during internal performance monitoring.

This message does not appear under normal operating conditions. Note the message and click Yes to continue operations or No to terminate operations. If the fault recurs, stop operations, and cycle instrument power. If the fault still persists, remove the instrument from service and return it to a Fluke Service Center for repair, along with a description of the error message.

A/D Zero Offsets Invalid! Continue?

Your instrument has detected a fault during internal performance monitoring.

This message does not appear under normal operating conditions. Note the message and click Yes to continue operations or No to terminate operations. If the fault recurs, stop operations, and cycle instrument power. If the fault still persists, remove the instrument from service and return it to a Fluke Service Center for repair, along with a description of the error message.

All associated configurations will be lost. Continue?

You are deleting all the instruments in the Communications Configuration File, which will also clear the configuration data from the instruments and remove all the instruments from the Icon Bar and network.

Clearing the Communications Configuration File of all network instruments invalidates all references to network instruments in *all* setup files as the Communications Configuration File is common to all setup files. Click Yes to proceed or No to cancel the operation.

All Slave instruments will become Async. Continue?

You are setting a Master instrument back to an Asynchronous instrument.

A group instrument consists of a Master and one or more Slaves. If you redefine the Master as an Asynchronous instrument, then the Slaves will automatically also become Asynchronous. Click Yes to proceed or No to cancel the operation.

Analog Processor not responding! Continue?

Your instrument has detected a fault during internal performance monitoring.

This message does not appear under normal operating conditions. Note the message and click Yes to continue operations or No to terminate operations. If the fault recurs, stop operations, and cycle instrument power. If the fault still persists, remove the instrument from service and return it to a Fluke Service Center for repair, along with a description of the error message.

Analog Processor not responding!

Your instrument may have experienced a failure.

Stop operations and cycle instrument power. On rare occasions when measuring extremely noisy inputs at maximum voltage levels, the analog processor may fail to respond. In this case, try to reconfigure the instrument. If the problem persists, return the instrument to a Fluke Service Center for repair.

Are you sure you want to Delete All?

You are deleting all the instruments in the Communications Configuration File, which will remove all the instruments from the network.

Clearing the Communications Configuration File of all network instruments invalidates all references to network instruments in *all* setup files as the Communications Configuration File is common to all setup files. Click Yes to proceed or No to cancel the operation.

Are you sure you want to Delete?

You are deleting an instrument in the Communications Configuration File, which will remove it from the network.

Clearing the Communications Configuration File of an instrument invalidates references to the instrument in *all* setup files as the Communications Configuration File is common to all setup files. Click Yes to proceed or No to cancel the operation.

Associated configuration will change to reflect new instrument model. Continue?

You are modifying an instrument model number in the Communications Configuration File, which will also modify the instrument model number for the associated icon on the Icon Bar.

Associated icon will change to the new number. Continue?

You are modifying an instrument BCN in the Communications Configuration File, which will also modify the BCN for the associated icon on the Icon Bar.

Attempt to set instrument to invalid time - Verify your PC time!

When logging starts, the instrument time is set according to the clock on your PC. If your PC date and time settings are invalid, the instrument time cannot be set and this message will appear.

Reset the date and time on your PC. If this message continues to appear, check your PC's clock batteries and replace if necessary.

Attempt to start Trend Link failed!

Trend Link could not start.

Make sure Trend Link is installed. Note the directory used for the installation and try again. If prompted for the directory location, enter the path to the location of the Trend Link installation. If Trend Link is not installed, see the procedures in Chapter 2.

Bad calibration input value - Check your source!

Your calibrator did not input a valid calibration value to the instrument.

Check your calibrator output, particularly for 4-wire connections (Ohms for example) as the calibrator must be configured for both Sense and Source.

Base Channel Number must range from 1 to 99!

You tried to enter the number 00, or other characters. Select a number in the range 01 to 99.

Batch information in data set has been corrupted!

This will occur when NetDAQ Logger starts logging into an existing Trend Link data file for which the batch information has been corrupted. The best workaround is to start logging into a new Trend Link data file.

Boot ROM Failure! Continue?

Your instrument has detected a fault during internal performance monitoring.

This message does not appear under normal operating conditions. Note the message and click Yes to continue operations or No to terminate operations. If the fault recurs, stop operations, and cycle instrument power. If the fault still persists, remove the instrument from service and return it to a Fluke Service Center for repair, along with a description of the error message.

Calibration Constants Corrupted! Continue?

Your instrument has detected a fault during internal performance monitoring.

This message does not appear under normal operating conditions. Note the message and click Yes to continue operations or No to terminate operations. If the fault recurs, stop operations, and cycle instrument power. If the fault still persists, remove the instrument from service and return it to a Fluke Service Center for repair, along with a description of the error message.

Calibration Mode not enabled! See service manual.

You have not pressed the calibration button behind the instrument front panel CALIBRATION SEAL.

Do not enable calibration unless you have all the equipment for a complete instrument calibration procedure, as defined in the Service Manual.

Cannot access specified drive [Drive] for Trend Link data!

You specified a disk drive for the Trend Link data file that cannot be used.

Check the availability of the disk drive you selected for the Trend Link data file.

Cannot add [Channel] to the Trend Link Data Set! Check amount of free disk space available.

You have tried to add another tag (instrument channel) to the Trend Link data file when the disk space is insufficient.

To use this disk drive, delete unneeded files to create space for the new Trend Link tags and try again. To delete old Trend Link data files, see "Deleting Old Trend Link Files" in Chapter 5 of this manual.

Cannot add more grouped Trend Link Data Sets! Delete a Data Set(s) or create a new Data Set.

Your `infolink.ini` file specifies more than 25 instruments for a group instrument.

A Data Set is opened for each instrument in a group instrument and each data set is created by appending 1 of 25 letters in the alphabet. If more than 25 letters are required, then this message appears. To delete old Trend Link files, see "Deleting Old Trend Link Files" in Chapter 5 of this manual.

Cannot change Configuration while logging!

You tried to copy channels to an instrument that was logging.

Copy channels only to instruments that are not logging.

Cannot create data file!

You are trying to start logging into a directory that does not exist or into a "read only" file.

Correct the data file name and directory path or use File Manager to check the data file properties.

Cannot create file [File Name]!

Your output file for a conversion utility (Utilities menu) cannot be created.

Enter a valid file name and directory path for the output file.

Cannot create Trend Link Data Set directory [Directory]. Check directory permissions or free disk space.

Trend Link is unable to create the Data Set directory for your Trend Link data file.

Check that the directory permission is not set to Read-Only, check the path for your data file to make sure the directory path allows access, and verify you have sufficient disk space for the new directory.

Cannot create Trend Link Data Set dummy file [File Name]!

Trend Link is unable to create the Data Set * .set file for your Trend Link data file.

Verify that the Data Set directory permission is not set to Read-Only, check the path for your data file to make sure the directory path allows access, and verify you have sufficient disk space for the new files.

Cannot write to Trend Link Data Set! Check amount of free disk space available.

You are trying to write to a Trend Link data file on a disk drive that has little or no storage capacity.

To use this disk drive, delete unneeded files to create space for the Trend Link data file with its associated data set. To delete old Trend Link data files, see "Deleting Old Trend Link Files" in Chapter 5 of this manual.

Cannot write to Trend Link infolink.ini! Check file permissions or location of file.

Trend Link is unable to write to your `infolink.ini` file.

The Trend Link `infolink.ini` file is either missing, corrupted, is from a previous version of Trend Link, or is write-protected. Trend Link will look for the `infolink.ini` file in one of three places. The default location is in the `c:\Program Files\Fluke\tl` directory. Refer to Chapter 4 of your *Trend Link for Fluke* manual for more information. Check your Trend Link installation or reinstall Trend Link using the procedures in Chapter 2.

Cannot open data file!

Your data file cannot be opened.

Enter a valid file name and directory path.

Cannot open file [File Name]!

Your input file for a conversion utility (Utilities menu) cannot be opened.

Enter a valid file name or valid formatted file.

Cannot write to NETDAQ.INI file! Check file permissions.

You are not being allowed to write to the `c:\Program Files\Fluke\netdaq\netdaq.ini` file (assuming you have used the default directory).

Check the permissions for the `netdaq.ini` file. In particular, remove Read-Only protection. If you have `netdaq.ini` opened in an editor or some other application, close that application.

Changes made in lower level dialog boxes will be lost. Are you sure you want to cancel?

This will occur in the Instrument Configuration, Channels Configuration, and Data File Configuration dialog boxes if the user cancels after having made changes in lower level dialogs under these dialogs. For example, if the user okays

changes in the Auto Rollover dialog box and then cancels the Data File Configuration dialog box, the message will appear.

Channel [GCN] must be defined for calculation of computed channel [GCN]

You tried to reference a channel set to OFF in a computed channel definition.

Make sure the channels you reference in computed channels have a function, even if the function is another computed channel.

Communications Configuration File is Damaged! Delete CCF.CFG file and reconfigure communications.

Your c:\Program Files\Fluke\netdaq\ccf.cfg file is corrupted.

Close NetDAQ Logger. Use the Windows Explorer feature to delete the existing ccf.cfg file. Open NetDAQ Logger, and then select the Communications Config command from the Setup menu to create a new ccf.cfg file. Reenter the network parameters for each instrument.

Communication Interruption!

Communications with your instrument have been interrupted. This may be a temporary condition.

Acknowledge the message. If the problem persists, check the network connections and make sure the instrument is powered.

Communication Parameters Corrupted! Continue?

Your instrument has detected a fault during internal performance monitoring.

This message does not appear under normal operating conditions. Note the message and click Yes to continue operations or No to terminate operations. If the fault recurs, stop operations, and cycle instrument power. If the fault still persists, remove the instrument from service and return it to a Fluke Service Center for repair, along with a description of the error message.

Communications with this instrument have already been opened!

You are trying to communicate with an instrument after communications have already been established with the instrument.

This message does not appear under normal operating conditions. Close NetDAQ Logger and restart the application.

Computed channel [Channel #]: Instrument equation buffer size limits will be exceeded!

The instrument's buffer space for storing equation tokens (1000 bytes) has been exceeded.

Delete or modify the equations until they occupy no more than 1000 bytes. If this message continues to appear when you click OK, continue to modify or delete equations as necessary. See Equation Syntax for instructions on entering equation for computed channels.

Computed channels must be calculated from lower numbered channels!

You tried to create a computed channel that has a lower channel number than the channels used for the computed function.

Use channels that are lower when creating a computed channel function. For example, if creating computed channel 24 for channel averaging, then the channels used for channel averaging must be lower, e.g., channel 23, 18, 6 and so forth.

Configuration will be lost! Delete anyway?

You are deleting an icon from the Icon Bar, which will clear the instrument of configuration data. Click Yes to proceed or No to cancel the operation.

To save configuration data for all the instruments, save the setup as a new setup file. (Select the Save Setup As command from the Setup menu.)

Connection is Down!

Your network cannot support the connection with the instrument.

For the general network, this is usually caused by network downtime. Verify your general network is operating. For the isolated network, this may be caused by an Ethernet interface failure at the instrument. Cycle the instrument power and try again. If the problem persists, your instrument may need service.

Connection Successful!

You have successfully communicated with the selected instrument.
Click OK.

Connection Successful, but instrument has older software that will not support computed channel equations or custom RTDs!

You have successfully established communications with an instrument and can continue to operate, but you will not be able to use computed channel equations or custom RTDs.

As long as you do not attempt to set computed channel equations or custom RTDs in NetDAQ Logger, you can continue to operate with your current software. If you want to use these features, you will need to contact your Fluke Service Center for a firmware upgrade.

Constant too Large!

Your equation contains a constant that exceeds the maximum limit of 3.402823e38.

Modify the equation as necessary so no constants exceed this limit.

Conversion is complete!

Indicates the conversion for Binary to ASCII Conversion, ASCII Timestamp Conversion, or Binary to Trend Link Conversion (Utilities menu) is complete.

Converting File: [% Complete]

Gives the status of file conversion activities in percent complete for Binary to ASCII Conversion, ASCII Timestamp Conversion, and Binary to Trend Link Conversion (Utilities menu).

During file conversion, you can click the Abort button to terminate the conversion process.

Copying to different model. Some channel definitions may differ. Continue?

You are trying to copy channel configurations between different models.

Channel functions and ranges are different for each instrument. For example, the maximum volts dc range is 50V for the 2645A and 300V for the 2640A (channels 1 and 11), and there is no 2-wire RTD function for the 2645A. Click Yes to copy the channels configuration as closely as possible between instrument models, or No to cancel the operation.

Current Master instrument will become a Slave. Continue?

You are changing a Slave instrument into a Master instrument.

A group instrument consists of a Master and one or more Slaves. If you redefine a Slave as a Master, the old Master becomes a Slave. Click Yes to proceed or No to cancel the operation.

Current Master instrument will become Async. Continue?

You are changing an Asynchronous instrument into a Master instrument.

A group instrument consists of a Master and one or more Slaves. If you redefine an Asynchronous instrument as a Master, the old Master becomes an Asynchronous instrument. Click Yes to proceed or No to cancel the operation.

Currently logging instruments will be stopped!

You tried to exit NetDAQ Logger while instruments are still logging.

If you wish to exit and stop all logging, click OK. To keep the application open until logging has stopped, click Cancel.

Demo Version of NetDAQ Logger - 60 minutes is up!

Your NetDAQ Logger demonstration software has been in operation for 60 minutes.

Close the application. You may open the application again for another 60 minutes of operation, if desired.

Demo Version of NetDAQ Logger - will stop after 60 minutes!

You will be able to use the NetDAQ Logger software in the demonstration mode for up to 60 minutes.

After the 60 minutes is over, the message "Demo Version of NetDAQ Logger - 60 minutes is up!" appears. You must close the application and, if desired, open it again for another 60 minutes of operation.

Duration Interval must be greater than zero!

You tried to enter a duration interval of 0 or else entered extraneous characters.

Enter a duration interval greater than 0. The format is Hours:Minutes:Seconds.

Entered values do not generate valid Mx+B values!

Your Input Range and Scaled Range values for the Mx+B calculation generate invalid M and/or B values.

Enter Input Range and Scale Range values such that M and B are less than +9.9999E+9.

Error registering window class!

Windows was unable to open NetDAQ Logger due to a conflict with other versions of Windows, or Windows is operating with marginal memory.

Error returned from Trend Link function [Error]

The Trend Link application has experienced an error.

The Trend Link error message that appears will indicate the fault experienced by Trend Link.

Ethernet Chip Failure! Continue?

Your instrument has detected a fault during internal performance monitoring.

This message does not appear under normal operating conditions. Note the message and click Yes to continue operations or No to terminate operations. If the fault recurs, stop operations, and cycle instrument power. If the fault still persists, remove the instrument from service and return it to a Fluke Service Center for repair, along with a description of the error message.

Ethernet Parameters Corrupted! Continue?

Your instrument has detected a fault during internal performance monitoring.

This message does not appear under normal operating conditions. Note the message and click Yes to continue operations or No to terminate operations. If the fault recurs, stop operations, and cycle instrument power. If the fault still persists, remove the instrument from service and return it to a Fluke Service Center for repair, along with a description of the error message.

Exceeded Nested Parentheses Limit!

Your equation contains too many sets of nested parentheses.

Do not use more than three sets of nested parentheses. The following examples demonstrate how you should construct your equations when you use nested parentheses:

Allowed:

$$(-2*c21/c2)/(2*((c1+1)-(c21/c2)*(c1-1)))$$

Not Allowed:

$$(-2*(abs(c1/(c2-c3))))$$

Existing data file is not compatible for appending!

You tried to log data to a data file in the Append mode but have added or subtracted instrument channels from the configuration since the previous logging session.

Change the instrument channels back to their original settings, log to a new data file, or rename the original file. You cannot append a data file after adding or subtracting channels. You can, however, append a data file if you change channel functions or ranges.

File Size must be between 200 and 100000!

You entered an invalid File Size into the Auto Rollover dialog box.

Enter a value between 200 and 100000 k bytes.

Front Panel Display Failure! Continue?

Your instrument has detected a fault during internal performance monitoring.

This message does not appear under normal operating conditions. Note the message and click Yes to continue operations or No to terminate operations. If the fault recurs, stop operations, and cycle instrument power. If the fault still persists, remove the instrument from service and return it to a Fluke Service Center for repair, along with a description of the error message.

Front Panel Display Not Responding! Continue?

Your instrument has detected a fault during internal performance monitoring.

This message does not appear under normal operating conditions. Note the message and click Yes to continue operations or No to terminate operations. If the fault recurs, stop operations, and cycle instrument power. If the fault still persists, remove the instrument from service and return it to a Fluke Service Center for repair, along with a description of the error message.

Hour of Day must be between 0 and 23!

You entered an invalid Hour of Day into the Auto Rollover dialog box.

Enter a value between 0 (midnight) and 23.

Instrument [BCN] already has this filename!

You have configured more than one instrument with the same data file name.

Check your data file names and make sure each instrument has a unique data file name, or uncheck Enable Data File Recording in the Data File Configuration dialog box.

Instrument BCN does not match! Reconfigure Communications!

You have a BCN mismatch between what is entered at the instrument and what is entered in NetDAQ Logger.

The BCN shown on the Icon Bar and the BCN shown on the instrument front panel do not agree. Change one or the other. If you change the BCN for an instrument, you must change it at both the instrument front panel and in the Communications Configuration File.

Instrument has older software that will not support computed channel equations or custom RTDs!

You attempted to configure computed channel equations or custom RTDs on an instrument that does not support these features.

As long as you do not attempt to set computed channel equations or custom RTDs in NetDAQ Logger, you can continue to operate with your current software. If you want to use these features, you will need to contact a Fluke Service Center for a software upgrade.

Instrument is busy completing its last received command!

Your instrument is currently processing a command and cannot accept another command until the first command operation is complete.

This can occur when sending a command to an instrument after aborting the Reading Remaining Scan process, particularly when the measurement time of a scan is long. Long measurement times result from configuring several channels with slow-reading functions such as frequency and AC volts.

Instrument is in use by another PC, or Socket Port number is incorrect!

You are trying to operate the instrument from more than one host computer, or the instrument Socket Port does not match the host computer Socket Port.

Operate the instrument from one host computer at a time, or check the Socket Port settings at both the instrument and host computer.

Instrument model does not match! Reconfigure Communications!

The instrument model does not match the entry in the Communications Configuration File.

Modify the instrument model number in the Communications Configuration File (select the Communications Config command from the Setup menu and click the Modify button).

Instrument not found!

You have a communications problem with the instrument or with the network. (The host computer Ethernet interface is operating correctly, i.e., the problem is not with the host computer.)

If the network connection has never worked, check the installation procedures in Chapter 2, or "Troubleshooting Network Problems."

If the network connection stopped working, check the following:

Network Connections Verify all network connections. For the isolated network using 10Base2 coaxial cable, be sure the 50-Ohm terminations at the network endpoints are still in place, especially if you have made a direct connection between the instrument and the host computer. For a network using 10BaseT unshielded twisted-pair cable, be sure you have used a standard cable when connecting to a hub, or a reverse-signal cable (reversing the transmit and receive wires) when making a direct connection between the instrument and the host computer.

Instrument Preparation Verify the instrument is powered and prepared for operation. The network parameters entered at the front panel of the instrument must agree with the network parameters at the host computer Communications Configuration File. For the isolated network, this includes the BCN and isolated network. For the general network, this includes the BCN, general network, socket port, IP address and default gateway.

Instrument Scan Queue Overflow! Newest scans discarded.

NetDAQ Logger is unable to retrieve scans from the instruments quickly enough and the instrument scan queue has overflowed. In this condition, the instrument is discarding the newest scans and saving the oldest scans.

Improve the data throughput characteristic. (See "Optimizing Performance for Speed" in Chapter 4 of this manual.) When the scan queue overflows, the action taken depends on your setting in the `netdaq.ini` file, i.e., discard the newest scans or overwrite the oldest scans. (See, "Configuring the `netdaq.ini` file" in Chapter 3 of this manual.)

Instrument Scan Queue Overflow! Oldest scans overwritten!

NetDAQ Logger is unable to retrieve scans from the instruments quickly enough and the instrument scan queue has overflowed. In this condition, the instrument is overwriting the oldest scans and saving the newest scans.

Improve the data throughput characteristic. (See "Optimizing Performance for Speed" in Chapter 4 of this manual.) When the scan queue overflows, the action taken depends on your setting in the `netdaq.ini` file, i.e., discard the newest scans or overwrite the oldest scans. (See, "Configuring the `netdaq.ini` file" in Chapter 3 of this manual.)

Instrument software is outdated for this version of NetDAQ Logger!

You are attempting to communicate with an instrument whose software is incompatible with this version of NetDAQ Logger.

Contact your Fluke Service Center to have your instrument software upgraded.

Instruments with invalid BCNs [Setup File Name] not loaded! Configure communications with desired BCNs!

You have tried to load instrument icons from a setup file for instruments that do not appear in the Communications Configuration File.

The Communications Configuration File dialog box (select the Communication Config command from the Setup menu) has an Instruments on Network list, which is common to all setup files. When a setup file is opened and contains icons for instruments that are no longer on the Instruments on Network list, this message appears. You must add the missing instruments to the Instruments on Network list that you removed in other operations and then reopen the setup file to place the instruments back on the Icon Bar.

Invalid Actual Calibration Value! Choose a value closer to the suggested value!

You have selected a calibration input value that is invalid.

Calibration consists of entering specified values over the range of the instrument input. You must select these or similar values for proper calibration. If you select values too far from an acceptable input, they will not be accepted as calibration values.

Invalid Alarm Value!

You have entered an alarm value that is excessively large.

Select an alarm value that is less than $+9.9999E+9$.

Invalid Channel Number!

Your equation contains a channel number that is not expressed with the correct syntax.

When used within an equation, channel numbers must be preceded by the letter 'c' (or 'C'). The channel number itself is expressed as an integer between 1 and 30. For example, channel 21 should be expressed as c21 (or C21).

Invalid Equation!

NetDAQ Logger attempted to read an equation that is missing or was entered in invalid syntax.

This messages appears when a computed function is defined as Equation, but the equation is either missing from the dialog box or was entered in a format that cannot be read by NetDAQ Logger. Verify the equation has been entered, check for missing operators or operands, misspelled operators, or illegal characters, and correct the equation as necessary.

Invalid Factor (M) Value!

You have entered a Factor (M) value for $Mx+B$ scaling that is excessively large. Select a M value that is less than $+9.9999E+9$.

Invalid IP Address or Socket Port Number! Reconfigure Communications!

Your Communications Configuration File does not have a valid IP Address, or Socket Port for this instrument. (General Network only.)

Make sure you have not set an IP address to 000.000.000.000 in the Communications Configuration File. (Select the Communications Config command from the Setup menu.)

Invalid Maximum Value for Scaled Range!

You have entered an invalid Maximum Value for the $Mx+B$ Input Range calculation.

Enter a Maximum Value that is less than $+9.9999E+9$.

Invalid Maximum Value for Input Range!

You have entered an invalid Maximum Value for the $Mx+B$ Input Range calculation.

Enter a Maximum Value that is less than $+9.9999E+9$.

Invalid Minimum Value for Scaled Range!

You have entered an invalid Minimum Value for the $Mx+B$ Input Range calculation.

Enter a Minimum Value that is less than $+9.9999E+9$.

Invalid Minimum Value for Input Range!

You have entered an invalid Minimum Value for the $Mx+B$ Input Range calculation.

Enter a Minimum Value that is less than $+9.9999E+9$.

Invalid Offset (B) Value!

You have entered an Offset (B) value for $Mx+B$ scaling that is excessively large.

Select a B value that is less than $+9.9999E+9$.

Invalid Plot Maximum Value!

You have entered a Plot Maximum value that is excessively large.

Select a Plot Maximum value that is less than $+9.9999E+9$.

Invalid Plot Minimum Value!

You have entered a Plot Minimum value that is excessively large.

Select a Plot Minimum value that is less than $+9.9999E+9$.

Invalid Value!

You entered a value in a format that cannot be read by NetDAQ Logger.

Re-enter the value according to the instructions for the dialog box, which are available within Online Help (use the Search feature in the Help menu).

IP Address segments must range from 0 to 255!

You tried to enter an IP address segment that is over 255.

An IP address is 32 bits divided into four octets (8 bits), with each octet expressed in dotted-decimal format. For example, 198.187.246.101. The maximum decimal number expressed by 8 bits is 255, therefore, the largest possible IP address segment is 255.

Low on memory!

The current Windows memory level cannot support your operations.
Close all applications and restart Windows.

Maximum number of Instruments reached!

You tried to add more than 20 instruments to the Icon Bar.
The maximum number of instruments on the Icon Bar is 20. If you wish to add a new instrument, you must first delete an existing instrument on the Icon Bar.

Min. Free Disk Space must be between 0 and 100000!

You entered an invalid Low Disk Space amount into the Auto Rollover dialog box.
Enter the number of k bytes as a number between 0 and 100000. This amount will be used as the Low Disk Space amount, and should be entered into the Low Disk Space field in the Auto Rollover dialog box.

Minimum and Maximum values for Input Range must be farther apart!

You have entered invalid Minimum and Maximum values for the input range of the Mx+B calculation.
Enter representative values for the Minimum and Maximum Input Range that are farther apart, for example, 0 and 100 for Celsius calculations. Very small values such as .00001 and .00002 cannot be used for the required calculations.

Missing channel number reference!

A computed channel equation must contain at least one reference to another configured channel.
Amend the equation to refer to another channel.

Missing left parenthesis!

You neglected to use a complete set of parentheses to delimit the argument to a function.
This message will show the location of the error. Amend the equation as necessary so a complete set of parentheses is used to delimit the argument.

Missing right parenthesis!

One of the sets of parentheses in your equation is not complete, leaving a left parenthesis without a matching right one.

Check each set of parentheses in your equation to locate the one that is missing the right parenthesis.

Must Select Function for Monitor Channel!

You selected a Monitor Channel that has the function OFF.

Select a Monitor Channel that has a function, e.g., volts dc, thermocouple, Ohms.

Mx+B Load File is Invalid!

You attempted to load an Mx+B File which cannot be read by NetDAQ Logger, either because the file contains invalid input, or because it is larger than 1 k byte.

If possible, the line which caused the error will be displayed with this error message allowing you to locate the invalid line in the Mx+B file. Change the syntax of all invalid lines in the file in accordance with the instructions under Loading an Mx+B File.

NetDAQ Logger software is not compatible with Setup File version: xx

You attempted to load a setup file that is not compatible with this version of NetDAQ Logger software.

Contact your Fluke Service Center for a software upgrade. You will need to provide a description of this error message along with the current version numbers of both the Setup File and NetDAQ Logger.

NetDAQ Logger software is outdated for this instrument!

The NetDAQ Logger software you are running is not compatible with the software on your instrument.

Contact your Fluke Service Center to obtain an updated version of the NetDAQ Logger software.

No channels defined!

You are trying to start logging for an instrument that has no configured channels (all channels show OFF in the Function column in the Main Window).

Configure at least one channel for a function, e.g., volts dc, thermocouple, Ohms.

No instruments are available for association!

You tried to create an instrument icon from the Available Instruments list when there were no instruments listed.

Instruments on the network are either shown as icons on the Icon Bar or are listed on the Available Instruments list. Adding a new instrument to the network and Icon Bar is a 2-step process. First, you add the instrument to the Communications Configuration File, where all the network parameters are saved (select the Communications Config command from the Setup menu). The new instrument appears on the Available Instruments list. Second, you create an instrument icon (select the Create Instrument Icon command from the Setup menu) by selecting the instrument from the Available Instruments list. When an instrument is placed on the Icon Bar, it is removed from the Available Instruments list. When an instrument is removed from the Icon Bar, it is returned to the Available Instruments list.

No timers available! Close another application and try again!

Windows timer resources have been exceeded.

Close other applications to free Windows timers and continue operations.

Not responding to command!

Your instrument has detected a fault during internal performance monitoring.

This message does not appear under normal operating conditions. Note the message and click Yes to continue operations or No to terminate operations. If the fault recurs, stop operations, and cycle instrument power. If the fault still persists, remove the instrument from service and return it to a Fluke Service Center for repair, along with a description of the error message.

Only [Number] bytes free disk space remain on [Drive] for Trend Link data!

You are logging to a Trend Link file and the minimum Low Disk Space amount has been reached.

When you are logging to a Trend Link data file, NetDAQ Logger periodically checks for available disk space. When this space reaches the value set in the Auto Rollover dialog box, this warning is displayed and a rollover of the Data Set file automatically takes place. To change the disk space default value (1000 k bytes), refer to Low Disk Space for Trend Link section of the Auto Rollover dialog box.

Out of Memory! Close another application and try again!

You have run out of Windows memory.

Close other applications to free Windows memory and continue operations.

PC time earlier than existing Trend Link data! Verify PC time, wait [nn] seconds, or create a new Data Set.

This message indicates that the Trend Link Data Set you are trying to initialize or log to has a timestamp that is newer than the current PC time.

This message can occur under the following conditions:

- The Instrument clock is slightly faster than the PC clock. If NetDAQ Logger runs for several days, then when the instrument is stopped, the last recorded timestamp may be later than the PC time. In this case, wait for the PC time to “catch up” before trying to initialize the Trend Link data file for collecting additional data. For example, if the PC time is 1 minute behind the instrument time, wait at least 1 minute before restarting. You can also create a new Trend Link Data Set.
- The PC clock is losing time. Reset the PC clock to the correct time. If this problem continues, you may have to replace the battery in your PC that powers the internal clock.
- The PC clock is set to a new time. You will not be able to log data to an existing Trend Link file after changing the PC clock to a time earlier than the timestamps in the Trend Link file. To continue, let the PC time catch up to the time recorded in the timestamps or create a new Trend Link file.

Performing Rollover.

This is a status message that appears at the end of converting a binary data file to a Trend Link data file. It indicates that the Trend Link *.now file just created by the conversion procedure is being rolled over into a *.t1g (history) file.

Plot Maximum must be larger than Plot Minimum!

You tried to configure a Quick Plot where the plot maximum was less than the plot minimum.

Change your Quick Plot maximum and minimum values such that the maximum value exceeds the minimum value.

Primary Interval must range from 0 to 24 hours (86400 seconds)!

You tried to enter a Primary Interval greater than 86400 or tried to enter extraneous characters.

Enter numbers only between 00000.000 and 86400.000 for the Primary Interval.

RAM Constants Corrupted! Continue?

Your instrument has detected a fault during internal performance monitoring.

This message does not appear under normal operating conditions. Note the message and click Yes to continue or No to terminate operations. If the fault recurs, stop operations, and cycle instrument power. If the fault still persists, remove the instrument from service and return it to a Fluke Service Center for repair, along with a description of the error message.

RAM Constants Corrupted!

Your instrument has detected a fault during internal performance monitoring.

This message does not appear under normal operating conditions. Note the message and click OK. If the fault recurs, stop operations, and cycle instrument power. If the fault still persists, remove the instrument from service and return to a Fluke Service Center for repair, along with a description of the error message.

RAM Failure! Continue?

Your instrument has detected a fault during internal performance monitoring.

This message does not appear under normal operating conditions. Note the message and click Yes to continue operations or No to terminate operations. If the fault recurs, stop operations, and cycle instrument power. If the fault still persists, remove the instrument from service and return it to a Fluke Service Center for repair, along with a description of the error message.

Reading Remaining Scans...

This message appears when you stop scanning and there are still scans in the instrument scan queue. When all the scans are read, the message clears, or you can click Abort and terminate the reading process.

Reconfigure Communications to include this instrument!

You have an error in your Communications Configuration File.

The Communications Configuration File resides in the `c:\Program Files\Fluke\netdaq` directory as `ccf.cfg`. If somehow this file has been deleted, modified, or copied to this directory from another source, you may have instrument icons without the attendant network parameters. If this condition

occurs, you must reconfigure communications to add the network parameters (select the Communications Config command from the Setup menu).

ROM Failure! Continue?

Your instrument has detected a fault during internal performance monitoring.

This message does not appear under normal operating conditions. Note the message and click Yes to continue operations or No to terminate operations. If the fault recurs, stop operations, and cycle instrument power. If the fault still persists, remove the instrument from service and return it to a Fluke Service Center for repair, along with a description of the error message.

RTD Alpha value must range from 0.00374 to 0.00393!

You entered an out-of-range RTD probe constant Alpha value.

Enter a value between 0.00374 and 0.00393. The default is 0.00385055.

RTD R0 value must range from 10 to 1010 Ohms!

You entered an out-of-range RTD R0 (ice point).

Enter an R0 value between 10 and 1010 Ohms. The default is 100 Ohms. (The R0, or ice point, refers to the resistance of the RTD at 0 degrees C.)

Sampling interval must range from 1 to 3600 seconds!

You tried to select a Quick Plot X-Axis Sampling Interval that was less than 1 second or more than 3600 seconds.

Reenter a Sampling Interval that is between 1 and 3600 seconds. The Quick Plot displays 40 interval points on the plot.

Select at least one group average channel!

You selected the Average Computed Channel or the Difference from Average function but did not specify any channels to average.

Select at least one channel from the Group Average list box for the Average Computed Channel function.

Select at least one spy channel!

You selected the Spy window but did not specify any channels to spy on.

Select at least one channel from the Channel list box for the Spy window feature.

Select at least one trigger type!

Your scan parameters do not include a type of trigger.

Configure your scan parameters to include at least one of the triggers: Interval Trigger, External Trigger or Alarm Trigger.

Selected Trend Link Data Set already contains data for instrument [BCN] Delete the Data Set or create a new Data Set.

The name you selected for your Trend Link data file is already being used by another instrument.

Select another data file name for this Trend Link file or delete the old Trend Link data set and try again. To delete old Trend Link data files, see "Deleting Old Trend Link Files" in Chapter 5 of this manual.

Setup File Is Invalid!

Your setup file is corrupted.

Delete the setup file and recreate a new setup file with the same name.

Setup has changed. Save the changes?

You tried to exit the application or select another setup file without saving the changes to the current setup file.

Select Yes to save the changes, No to not save the changes, or Cancel to return to your previous operation.

Shunt Resistance value must range from 10 to 250 Ohms!

You entered an out-of-range shunt resistance for dc current measurements.

Enter a shunt resistance value between 10 and 250 Ohms. The default is 10 Ohms.

Socket Error!

Your host computer is not able to connect to the network.

Check that your networking software has not been corrupted and is correctly installed. If necessary, reinstall your networking software as described in Chapter 2. Check that your Ethernet adapter is operating by using the diagnostic procedures that are on the diskette supplied with the adapter. You may have experienced a hardware failure in the Ethernet adapter.

Socket Port Number must range from 1024 to 65535!

You tried to enter a Socket Port number less than 1024, greater than 65535 or included extraneous characters.

Enter a Socket Port number between 1024 and 65535. The default is 04369.

There are no Trend Link data files to be initialized!

You do not have Trend Link selected as a data file format for any of the instruments, or instruments with the Trend Link data file format are already logging and therefore do not need initializing.

There is not enough free disk space on [Drive] for the Trend Link Data Set files!

You are trying to create a Trend Link data file on a disk drive that has little or no storage space.

To use this disk drive, delete unneeded files to create space for the new Trend Link data file with its associated data set. To delete old Trend Link data files, see "Deleting Old Trend Link Files" in Chapter 5 of this manual.

This Base Channel Number is already in use!

You tried to add an instrument to the Communications Configuration File with a BCN that is already in use.

Select a BCN number that is unique, that is, not used by any other instrument on the network. The range of BCNs is 01 to 99.

Time Interval must be between 1 and 99!

You entered an invalid Time Interval into the Auto Rollover dialog box.

Enter the number of hours as a whole number between 1 and 99. Do not enter minutes.

Time Interval must range from 1 minute to 999 hours and 99 minutes!

This will occur in the Batch Options dialog box when the user selects Periodic Interval with an interval value outside the stated range.

Time of Day must be entered as 0 to 23 hours and 0 and 59 minutes!

This will occur in the Batch Options dialog box when the user selects Periodic Interval and checks "Begin first interval at specified time," and enters a time outside the stated range.

Token String is too Large!

This equation exceeds the limit of 1000 bytes after it's been converted into binary format.

Once equations are converted into binary format (so they can be read by the instrument) they cannot exceed 1000 bytes in length. To reduce this equation's length, reference other computed channels (average, difference, and difference from average) in the equation.

Trend Link data file paths must begin with a drive letter. Universal Naming Convention (UNC) path names are not supported at this time.

This will occur in the 32-bit version only, in the Data File Configuration dialog box, when the user has selected an UNC path name for a Trend Link data file name.

Trend Link Data Set file not found! Close Trend Link, start logging again, and then reopen Trend Link.

A Trend Link data file that Trend Link is currently accessing has been deleted. Exit Trend Link, begin logging data again, and then re-open Trend Link.

Trend Link Data Set .NOW file already exists! Delete the Data Set or create a new Data Set.

You are attempting a Fast Binary (BIN) to Trend Link (SET) conversion using an existing Data Set name that contains a * .now file.

Choose new Trend Link file names when converting Fast Binary files instead of using existing names.

Trend Link file prefix must be 7 characters or less!

Your Trend Link data file name has 8 characters instead of 7 (or less) characters.

Trend Link file names are a maximum 7 characters (plus extension). For example, testdat.set. This is necessary because the data set directory is the same name as the data file name, preceded by an underscore, e.g., the data file testdat.set is in the directory _testdat.set.

Trigger Interval must range from 0 to 24 hours (86400 seconds)!

You tried to enter a Trigger Interval greater than 86400 or tried to enter extraneous characters.

Enter numbers only between 00000.000 and 86400.000 for the Primary Interval.

Unable to communicate with instrument!

You have not made RS-232 connection with the instrument for calibration procedures.

Check that the host computer and instrument have the same baud rate and are properly interconnected. (See the Service Manual for more information.)

Unable to Create Configuration Text File!

The name you selected for the text file already exists or is write protected or you have run out of disk space.

Unable to create Trend Link Data Set chart file [File Name]

Trend Link is unable to create the Data Set * .cht file for your Trend Link data file.

Check that the directory permission is not set to Read-Only, check the path for your data file to make sure the directory path allows access, and verify you have sufficient disk space for the new chart file.

Unable to get a Trend Link DLL function address!

Your Trend Link installation is missing the required `c:\Program Files\Fluke\tl\tbase.dll` file.

Check that your Trend Link installation is complete. You may also be trying to operate with portions of an older version of Trend Link. Reinstall Trend Link following the procedures in Chapter 2.

Unable to initialize DDE!

Windows is unable to support DDE operations due to low memory or other Windows resource problem.

Close all applications and restart Windows.

Unable to initialize Winsock! Verify that driver has been loaded.

Your `winsck.dll` file was found but could not be initialized.

If this is a new installation, you most likely forgot to reboot your computer after installing your TCP/IP software. If in doubt, reboot your computer NOW and try again. See if more than one `winsck.dll` file is on your computer and the wrong one is being loaded. If the problem persists, reinstall NetDAQ Logger software.

Unable to load Trend Link DLL!

NetDAQ Logger is unable to load the Trend Link `c:\Program Files\Fluke\tl\tbase.dll` into memory.

Check that you have sufficient memory space to load `tbase.dll`, that the `tbase.dll` has not been corrupted, or you are not trying to operate with portions of an older version of Trend Link. Reinstall Trend Link following the procedures in Chapter 2.

Unable to open Communications Configuration File!

You tried to open the Communications Configuration File but failed.

Check the read/write permissions for the `c:\Program Files\fluke\netdaq\ccf.cfg` file. This error can be caused by having this file Read-Only. Remove the Read-Only property from the file. Other causes include the `ccf.cfg` file does not exist or is corrupted. In either of these cases, close the application and delete the current `ccf.cfg` file. Then restart the application and select the Communications Config command from the Setup menu to create a new `ccf.cfg` file.

Unable to open communications socket with instrument!

You tried to communicate with the instrument and the Socket Port could not be opened.

The Windows resources are out of memory or there is a configuration problem with the networking software. For example, if you accidentally close the Winsock icon you will receive this message. Close all applications and restart Windows or close NetDAQ Logger and try again. Also check your networking software.

Unable to Open Mx+B File!

You have specified an Mx+B file that is not readable.

Make sure the file is a text file, and that it resides in a directory with the proper read permissions.

Unable to open RS232 port!

Your host computer RS-232 port cannot be opened.

Check your host computer RS-232 port operation. Your COM port may be disabled for an internal modem or other device or may be in use by another application. The RS-232 port is used only for calibration procedures.

Unable to Open Setup File!

You have specified a setup file name or directory that does not exist.

Check your files and directories for the correct name and path. If you are using this setup file on the NetDAQ Logger command line, change the command line to a valid file name and path. (See "Starting NetDAQ Logger with a Setup File" in Chapter 3 of this manual.)

Unable to read Trend Link default template chart file - tldf.cht!

Your NetDAQ Logger installation is missing the required `c:\Program Files\Fluke\netdaq\tldf.cht` file.

The installation of NetDAQ Logger may be corrupted. Reinstall NetDAQ Logger following the procedures in Chapter 2.

Unable to stop scanning!

You have lost communications with your instrument and scanning cannot be stopped.

When you lose communications with the instrument while scanning, it is indeterminate if it is a network problem or an instrument problem. If it is a network problem, then the instrument continues to scan. To remedy this situation, correct the communications problem and then click the Stop Instrument button (acknowledge the "Unable to stop scanning!" message) and then click the Start Instrument button again. You can also cycle the instrument power to stop scanning.

Unable to Write to Configuration Text File!

The name you selected for the text file already exists as a Read-Only file or you have run out of disk space.

Choose a different name for the text file, remove the Read-Only property of the existing file, or free up disk space.

Unable to Write to Data File! Check disk space.

You have run out of space on the disk drive used for your data file, or the disk drive is not responding.

Check your disk medium. If you are using a floppy disk, make sure the disk has not been removed from the drive.

If you are writing to a Trend Link data file and there is still free disk space remaining on your disk drive, data logging may have been stopped due to settings

in the Auto Rollover dialog box. You can change the minimum amount of free disk space that can exist while logging to a Trend Link file by changing the settings in the Low Disk Space for Trend Link section of the Auto Rollover dialog box.

Unable to Write to Setup File!

Your setup file properties do not allow writing to the file or the directory path no longer exists.

Use File Manager to check the properties of your setup file, i.e., be sure the file is not configured for Read Only, and check the setup file directory path.

Uncalibrated or Calibration Incomplete! Continue?

Your instrument detected a fault during internal performance monitoring.

This message does not appear under normal operating conditions. Note the message and click Yes to continue operations, or click No to terminate operations. If the fault recurs, stop operations and cycle the instrument's power. If the fault still persists, remove the instrument from service and return it to a Fluke Service Center for repair, along with a description of this error message.

Unknown Communication Error!

You have experienced an unknown communications error.

Make sure the socket port number in NetDAQ Logger and in the instrument are the same. If the problem persists, close NetDAQ Logger and restart the application.

WARNING: Only [Number] bytes of free disk space remain on [Drive] for Trend Link data!

You are logging to a Trend Link file and the minimum Low Disk Space amount has been reached.

When you start logging to a Trend Link data file, NetDAQ Logger periodically checks for available disk space. When this space reaches the value set in the Auto Rollover dialog box, this warning is displayed and a rollover of the Data Set file automatically takes place. To change the disk space default value (1000 k bytes), see the Help instructions for Low Disk Space for Trend Link in the Auto Rollover dialog box.

Window creation failed!

Windows was unable to open NetDAQ Logger due to insufficient resources such as insufficient memory in Windows.

Close all applications and restart Windows to clear the resource problem.

Winsock.dll not found!

The `winsock.dll` file cannot be found in any directory listed in your `c:\autoexec.bat` path.

Be sure you have enabled or installed networking software (see Chapter 2 of this manual).

Appendix K

Fluke Service Centers

USA

California

FLW
Fluke Calibration Center
C/o FLW Service Corporation
3505 Cadillac Ave., Bldg E
Costa Mesa, CA 92626
TEL: (714) 751-7512
FAX: (714) 755-7332

Dallas

Fluke Service Center
2104 Hutton Drive
Suite 112
Carrollton, TX 75006
TEL: (214) 406-1000
FAX: (214) 247-5642

Fluke Service Center
42711 Lawrence Place
Fremont, CA 94538
TEL: (510) 651-5112
FAX: (510) 651-4962

Illinois

Fluke Service Center
1150 W. Euclid Avenue
Palatine, IL 60067
TEL: (708) 705-0500
FAX: (847) 705-9989

New Jersey

Fluke Service Center
W. 75 Century Rd
Paramus, N.J. 07652-0930
TEL: (201) 599-9500 (599-0919)
FAX: (201) 599-2093

Washington

Fluke Service Center
Fluke Corporation
Building #4
1420 - 75TH St. S.W.
Everett WA 98203
TEL: (206) 356-5560
FAX: (206) 356-6390

INTERNATIONAL

Australia

Phillips Sci. and Ind., Pty., L.
745 Springvale Road
Mulgrave
Victoria 3170
TEL: 61-3-881-3666
FAX: 61-3-881-3636

Phil. Sci. & Ind. Bk F, Centrect.
34 Waterloo Road
North Ryde, N.S.W. 2113
TEL: 61-2-888-8222
FAX: 61-2-888-0440

Austria

Fluke Vertriebsges. GMBH (GM)
SudrandstraBe 7
P.O. Box 10, A-1232 Vienna
TEL: 43-1-614-100
FAX: 43-1-614-1010

Bahrain

Mohammed Fakhroo & Bros.
P.O. Box 439
Bahrain
TEL: 973-253529
FAX: 973-275996

Belgium

N.V. Fluke Belgium S.A.
Sales & Service Dept.
Langeveldpark - Unit 5 & 7
P.Basteleusstraat 2-4-6
1600 St. Pieters - Leeuw
TEL: 218-2-331-2777 (ext 218)
FAX: 32-2-331-1489

Bolivia

Casilla 7295,
Calle Ayacucho No. 208
Edificio Flores, 5to. Piso
La Paz, Bolivia
TEL: 591-2-317531 or 317173
FAX: 591-2-317545

Brazil

Philips Medical Systems, LTDA
Av. Interlagos North
3493 - Campo Grande
04661-200 Sao Paulo S.P.
TEL: 55-11-523-4811
FAX: 55-11-524-4873 (ID 2148)

Sigtron Instrumentos E. Servicios
Rua Alvaro Rodrigues
269 - Brooklin
Sao Paulo, Sp
TEL: 55-11-240-7359
FAX: 55-11-533-3749

Sistest
Sist. Instr. Testes Ltda
Av. Ataulfo De Paiva
135 S/ 1117 - Leblon 22.449-900 Rio De
Janeiro, Rj, Brazil
TEL: 55-21-259-5755 or 512-3679
FAX: 55-21-259-5743

Bulgaria

Ac Sophilco, Cust. Supp. Serv.
P.O. Box 42
1309 Sofia, Bulgaria
TEL: 359-2-200785
FAX: 359-2-220910

C.S.F.R.

Elsco
NA. Berance 2
16200 Praque 6
TEL: 42-2-316-4810
FAX: 42-2-364986

Data Elektronik BRNO
Jugoslavaska 113
61300 Brno
TEL: 42-5-57400-2
FAX: 42-5-574002

Canada

Fluke Electronics Canada Inc.
400 Britannia Rd East, Ut #1
Mississauga, Ontario
L4Z 1X9
TEL: 905-890-7600
FAX: 905-890-6866

Chile

Intronica, Instrumen Electronica, S.A.C.I.
Guardia Vieja 181 Of. 503
Casilla 16500, Santiago 9
TEL: 56-2-232-6700

China

Fluke S.C., Room 2111
Scite Tower
Jianguomenwai Dajie
Beijing 100004, PRC
TEL: 86-10-512-6351,6319, 3437
FAX: 86-10-512-3437

Colombia

Sistemas E Instrument., Ltda.
Calle 83, No. 37-07
Po Box 29583
Santa Fe De Bogota
TEL: 57-1-287-5424
FAX: 57-1-218-2660

Costa Rica

Electronic Engineering, S.A.
Carretera de Circunvalacion
Sabanilla Av. Novena
P.O. Box 4300-1000, San Jose
TEL: 506-253-3759 or 225-8793
FAX: 506-225-1286

Croatia

Kaltim - Zagreb
Fluke Sls & Serv. Draga 8
41425 Sveta Jana
TEL: 385-41-837115
FAX: 385-41-837237

Denmark

Fluke Danmark A/S, Cust. Supp.
Ejby Industrivej 40
DK 2600 Glostrup
TEL: 45-43-44-1900 or 1935
FAX: 45-43-43-9192

Ecuador

Proteco Coasin Cia., Ltda.
Av. 12 de Octubre 2449 y Orellana
P.O. Box 17-03-228-A, Quito
TEL: 593-2-230283 or 520005
FAX: 593-2-561980

Egypt

EEMCO
Electronic Equipment Mktng Co.
9 Hassan Mazher St.
P.O. Box 2009
St. Heliopolis 11361
Cairo, Egypt
TEL: 20-2-417-8296
FAX: 20-2-417-8296

Fed. Rep. of Germany

Fluke Deutschland Gmbh
Customer Support Services
Servicestutzpunkt VFN5
Oskar-Messter-Strasse 18
85737 Ismaning/Munich
TEL: 49-89-9961-1260
FAX: 49-89-9961-1270

Fluke Deutschland
(CSS), Servicestutzpunkt VFN5
Meiendorfer Strasse 205
22145 Hamburg
TEL: 49-40-679-6434
FAX: 49-40-679-7653

Finland

Fluke Finland Oy
Sinikalliontie 3, P.L. 151
SF 02631 Espoo
TEL: 358-0-6152-5600
FAX: 358-0-6152-5630

France

Fluke France S.A.
37 Rue Voltaire
BP 112, 93700 Drancy, Cedex
TEL: 33-1-4896-6300
FAX: 33-1-4896-6330

Greece

Philips S.A. Hellenique
Fluke Sales & Service Manager
15, 25th March Street, P.O. Box 3153, 177
78 Tavros Athens
TEL: 30-1-489-4911 or 4262
FAX: 30-1-481-8594

Hong Kong

Schmidt & Co, Ltd. 1st Floor
323 Jaffe Road
Wanchai
TEL: 852-9223-5623
FAX: 852 834-1848

Hungary

MTA MMSZ KFT, Srv. / Gen. Mgr
Etele Ut. 59 -61
P.O. Box 58
H 1502 Budapest
TEL: 361-186-9589 or 209-3444
FAX: 361-161-1021

Iceland

Taeknival HF
P.O. Box 8294, Skeifunni 17
128 Reykjavik
TEL: 354-1-681665
FAX: 354-1-680664

India

Hinditron Services Pvt. Inc.
33/44A 8th Main Road
Raj Mahal Vilas Extension
Bangalore 560 080
TEL: 91-80-334-8266 or 0068
FAX: 91-33-247-6844

Hinditron Services Pvt. Ltd
Hinditron House, 23-B
Mahal Industrial Estate
Mahakali Caves Rd, Andheri East
Bombay 400 093
TEL: 91-22-836-4560, 6590
FAX: 91-22-836-4682

Hinditron Services Pvt. Ltd
Castle House, 5th Floor
5/1 A, Hungerford Street
Calcutta 700 017
TEL: 91-33-400-194
FAX: 91-33-247-6844

Hinditron Services Pvt. Ltd
204-206 Hemkunt Tower
98 Nehru Place
New Delhi 110 019
TEL: 91-11-641-3675 or 643-0519
FAX: 91-11-642-9118

Hinditron Services Pvt. Ltd.
Field Service Center
Emerald House, 5th Floor
114 Sarojini Devi Road
Secunderabad 500 003
TEL: 91 40-844033 or 843753
FAX: 91-40-847585

Indonesia

P. T. Daeng Bro, Phillips House
J/n H.R. Rasuna Said Kav. 3-4
Jakarta 12950
TEL: 62-21-520-1122
FAX: 62-21-520-5189 or 62-21-520-5189

Israel

R.D.T Equipment & Sys, Ltd.
P.O. Box 58072
Tel-Aviv 61580
TEL: 972-3-645-0745
FAX: 972-3-647-8908

Italy

Fluke Italia S.R.L., CSS
Viale Delle Industrie, 11
20090 Vimodrone (MI)
TEL: 39-2-268-434-203 or 4341
FAX: 39-2-250-1645

Japan

Fluke Corp., Sumitomo Higashi Shinbashi
Bldg.
1-1-11 Hamamatsucho
Minato-ku, Tokyo 105
TEL: 81-3-3434-0188 or 0181
FAX: 81-3-3434-0170

Kenya

Walterfang
P.O. Box 14897
Nairobi, Kenya
TEL: 254-2
FAX: 254-2

Korea

B&P International Co., Ltd.
Geopung Town A-303
203-1 Nonhyun-Dong
Kangnam-Ku
Seoul 135-010
TEL: 82 12 546-1457
FAX: 82 12 546-1458

IL MYOUNG, INC.

Youngdong P.O. Box 1486
780-46, Yeogsam-Dong
Kangnam-Ku, Seoul
TEL: 82 2 552-8582-4
FAX: 82 2 553-0388

Kuwait

Yusuf A. Alghanim & Sons W.L.L.
P.O. Box 223 Safat
Alghanim Industries
Airport Road Shuwaikh
13003 Kuwait
TEL: 965-4842988
FAX: 965-4847244

Malaysia

CNN. SDN. BHD.
17D, 2nd Floor
Lebuhraya Batu Lancang
Taman Seri Damai
11600 Jelutong Penang

TEL: 60-4-657-9584

FAX: 60-4-657-0835

Mexico

Metro. Y Calibraciones Ind., S.A.
Diagonal No. 17 - 3 Piso
Col. Del Valle
C.P. 03100, Mexico D.F.
TEL: 52-5-682-8040
FAX: 52-5-687-8695

Netherlands

Fluke Nederland B.V. (CSS)
Afdeling Service
Science Park Eindhoven 5108
5692 EC Son
TEL: 31-40-2678
FAX: 31-40-2678

New Zealand

Phillips Scientific & Ind., Pty., L.
Private Bag 41904,
St. Lukes, 2 Wagener Place
Mt. Albert, Auckland 3
TEL: 64-9-894-4160
FAX: 64-9-849-7814

Nigeria

Philips Projects Centre
Resident Delegate / PMB 80065
8, Kofo Abayomi Street
Victoria Island, Nigeria
TEL: 234-1-262-0632
FAX: 234-1-262-0631

Norway

Fluke Norway A/S, Cust. Support
P.O. Box 6054 Etterstad
N-0601 Oslo
TEL: 47-22-653400
FAX: 47-22-653407

Pakistan (Philips)

Philips Elec. Ind. of Prof. Sys. Div. Islamic
Cham. of Commerce
St-2/A, Block 9, KDA Scheme 5,
Clifton, Karachi-75600
TEL: 92-21-587-4641 or 4649
FAX: 92-21-577-0348

Peru

Impor. & Repres. Electronicas S.A., JR.
Pumacahua 955
Lima 11
TEL: 51-14-23-5099
FAX: 51-14-31-0707

Philippines

Spark Electronics Corp.
P.O. Box 610, Greenhills
Metro Manila 1502
TEL: 63-2-700-621
FAX: 63-2-721-0491 or 700-709

Poland

Elec. Instr. Srv. Philips Cons.
UL. Malechowska 6
60 188 Poznan
TEL: 48-61-681998
FAX: 48-61-682256

Portugal

Fluke Iberica S.L.
Sasles Y Services Dept
Campo Grande 35 - 7b
1700 Lsboa
TEL: 351-1-795-1712
FAX: 351-1-795-1713

Romania

Ronex S.R.L., Cust. Supp. Serv.
Str. Transilvaniei Nr. 24
70778 Bucharest - I
TEL: 40-1-614-3597 or 3598
FAX: 40-1-659-4468

Russia

Infomedia
UL. Petrovsko Razumovsky
Proezd. 29
103287 Moscow
TEL: 7-95-212-3833
FAX: 7-95-212-3838

Saudi Arabia

A. Rajab & Silsilah Co. S&S Dept.
P.O. Box 203
21411 Jeddah
TEL: 966-2-661-0006
FAX: 966-2-661-0558

Singapore

Fluke Singapore Pte., Ltd.
Fluke ASEAN Regional Office
#27-03 PSA Building
460 Alexandra Road
Singapore 119963
TEL: 65-276-5161
FAX: 65-276-5929

South Africa

Spescom Measure. (PTY) Ltd.
Spescom Park
Cm. Alexandra Rd. & Second St.
Halfway House, Midrand 1685
TEL: 27-11-315-0757
FAX: 27-11-805-1192

Spain

Fluke Iberica S.L.
Centro Empresarial Euronora
c/Ronda de Poniente, 8
28760-Tres Cantos
Madrid, Spain
TEL: 34-1-804-2301
FAX: 34-1-804-2496

Sweden

Fluke Sverige AB, (CSS)
P.O. Box 61
S-164 94 Kista
TEL: 46-8-751-0235 or 0230
FAX: 46-8-751-0480

Switzerland

Fluke Switzerland AG, (CSS)
Rutistrasse 28
CH 8952 Schlieren
Switzerland
TEL: 41-1-730-3310 or 730-3932
FAX: 41-1-730-3932

Taiwan

Schmidt Scientific Taiwan, Ltd.
6th Floor, No. 109,
Tung Hsing Street
Taipei, Taiwan R.O.C.
TEL: 886-2-767-8890 or 746-2720
FAX: 886-2-767-8820

Thailand

Measuretronix Ltd.
2102/31 Ramkamhang Road
Bangkok 10240
TEL: 66-2-375-2733 or 2734
FAX: 66-2-374-9965

Turkey

Pestas Prof. Elektr. Sist. Tic. V
Selcuklar Caddesi
Meydan Apt. No. 49, Daire 23
Akattlar 80630 Istanbul
TEL: 90-212-282-7838
FAX: 90-212-282-7839

U.A.E.

Haris Al Afaq Ltd.
P.O. Box 8141
Dubai
TEL: 971-4-283623 or 283624
FAX: 971-4-281285

United Kingdom

Fluke U.K. LTD. (CSS)
Colonial Way
Watford, Hertfordshire WD2 4TT
TEL: 44-923-240511
FAX: 44-923-225067

Uruguay

Coasin Instromontos S.A.
Casilla de Correo 1400
Libertad 2529, Montevideo
TEL: 598-2-492-436, 659
FAX: 598-2-492-659

Venezuela

Coasin C.A.
Calle 9 Con Calle 4, Edif. Edinurbi
Piso-3
La Urbina
Caracas 1070-A, Venezuela
TEL: 58-2-241-6214
FAX: 58-2-241-1939

Vietnam

Schmidt-Vietnam Co., Ltd.
8/FI. Schmidt Tower
Hanoi International Tech. Ctr
KM8, Highway 32, Cau Giay
Tu Liem, Hanoi
Vietnam
TEL: 84-4-346186 or 346187
FAX: 84-4-346-188

West Indies

Western Scientific Co., Ltd.
Freeport Mission Road
Freeport, Trinidad
West Indies
TEL: 809-673-0038
FAX: 809-673-0767

Yugoslavia

Jugoelektro Beograd
T & M Customer Support Services
Knez Mihailova 33
11070 Novi
TEL: 38-11-182470
FAX: 38-11-638209

Zimbabwe

Field Technical Sales
45, Kelvin Road North
P.O. Box Cy535 Causeway
Harare, Zimbabwe
TEL: 263-4-750381 or 750382
FAX: 263-4-729970

Index

—1—

- 10Base2 (Coax) wiring, interconnection, 2-48
- 10BaseT (twisted-pair) Ethernet wiring, interconnection, 2-48

—2—

- 2640A 2-Wire resistance measurement specifications, A-13
- 2640A 4-Wire resistance measurement specifications, A-12
- 2640A ac voltage measurement specifications, A-9
- 2640A dc voltage measurement specifications, A-8
- 2640A frequency measurement specifications, A-16
- 2640A RTD's 2-Wire per ITS-1990 measurement specifications, A-14
- 2640A RTD's 4-Wire, per ITS-1990 measurement specifications, A-13
- 2640A specifications, A-7
- 2640A thermocouple per ITS-1990 measurement specifications, A-14
- 2640A/2645A combined specifications, A-1
- 2640A/2645A environmental specifications, A-3
- 2640A/2645A general specifications, A-1
- 2640A/2645A Input/Output capabilities, A-4

- 2640A/2645A real-time clock and calendar, A-7
- 2640A/2645A totalizer, A-7
- 2645A 2-Wire resistance measurement specifications, A-22
- 2645A 4-Wire resistance measurement specifications, A-21
- 2645A 4-Wire RTD per ITS-1990 measurement specifications, A-22
- 2645A ac voltage measurement specifications, A-19
- 2645A dc voltage measurement specifications, A-17
- 2645A frequency measurement specifications, A-25
- 2645A specifications, A-17
- 2645A thermocouple per ITS-1990 measurement specifications, A-23
- 2-Wire resistance accuracy test (2640A), 6-17
- 2-Wire resistance accuracy test (2645A), 6-18

—4—

- 4-Wire resistance accuracy test (2640A), 6-20
- 4-Wire resistance accuracy test (2645A), 6-23

—A—

- AC power, 2-6

- Accessing NetDAQ Logger commands, 3-3
- Accessories, options and, 1-14
- Accuracy performance tests, 6-11
- Adding an Instrument to the network, 3-5
- Adding or Changing the Chart Title, 5-23
- Adjusting the Curve Amplitude Scale (Y-axis), 5-16
- Adjusting the Curve Time Scale (X-axis), 5-15
- Alarm
 - master, 1-10, 2-14
 - trigger, 1-10
- Alarm specifications, master, A-6
- Alarm/trigger I/O connections, 2-12
- Alarms, 1-8, 3-23
- Analog channel integrity test, 6-15
- Analog channels
 - capabilities, 1-7
- Assigning channel labels, 3-24
- Asynchronous instrument operations, 1-12
- Auto rollover, 4-14

—B—

- Background Preferences, 5-21
- Base channel number, reviewing and setting the, 2-27
- Basic network packet and frame contents, I-6
- Binary data files
 - converting to ASCII, 4-18

—C—

- Calibration, 6-31
- Capabilities, instrument, 1-4
- Channel
 - labels, 3-24
 - monitoring, 1-8
- Channel equation
 - defining a computed, 3-20
- Channels
 - analog, 1-7
 - computed, 1-7
 - configuring, 3-18
 - copying, 3-26
 - numbering, 1-7

- Channels configuration dialog box, 3-18
- Chart Title, Adding or Changing the, 5-23
- Chart, Printing a, 5-24
- Cleaning, 6-4
- Clearing instrument totalizer value, 4-5
- Common mode voltage, 2-7
- Communications
 - network, I-2
 - RS-232, 1-13
- Communications configuration dialog box, 3-5
- Computed channel
 - defining an equation, 3-20
- Computed channel integrity test, 6-15
- Computed channels, 1-7
 - defining an equation, E-1
- Configuration commands, dimmed, 3-15
- Configuration lockout, using, 3-28
- Configuration, power-on, 2-21
- Configuring alarms, 3-23
- Configuring an instrument, 3-15
- Configuring analog channel functions, 3-19
- Configuring channels, 3-18
- Configuring computed channel functions, 3-20
- Configuring Mx+B Scaling, 3-22
- Configuring Mx+B scaling from a file, 3-25
- Configuring network communications, 3-4
- Configuring the Curve Status Display, 5-17
- Configuring the netdaq.ini file, 3-29
- Configuring the performance test setup, 6-6
- Connecting to a power source and instrument grounding, 2-5
- Connections
 - alarm/trigger I/O, 2-12
 - digital I/O, 2-11
 - universal input module, 2-7
- Connector set, instrument, 1-15
- Controls
 - front panel, 2-17
 - rear panel, 2-20
- Controls and indicators, 2-15
- Converting a data file from Binary to ASCII, 4-18
- Converting data files, 4-18

Copying channels, 3-26
Creating instrument icon, 3-8
Crosstalk considerations, 2-11, B-2
Current setup
 saving the, 3-11
Curve Preferences, 5-18
Curve Status Display, Configuring the, 5-17
Custom-385 RTD, D-2

—D—

Data file format, F-1
Data files
 ASCII, 4-13
 binary, 4-13
 configuring, 4-14
 converting, 4-18
 converting from Binary to ASCII, 4-18
 trend link, 4-14
 viewing and printing, 4-18
Data transmission and storage rate,
 increasing, 4-20
DC power, 2-7
DDE example using Excel, G-2
DDE links reference, G-1
Deadband values
 specifying, 4-16
Defining a computed channel equation, 3-20
Deleting an instrument from the
 Network, 3-7
Deleting instrument icon, 3-9
Describing the instruments, 3-25
Designating instruments
 asynchronous, 3-9
 group, 3-9
Digital I/O, 1-8, 2-12, A-4
Digital I/O connections, 2-11
Digital I/O output test, 6-26
Digital input test, 6-27
Digital input/output tests, 6-26
Dimmed configuration commands, 3-15
Display
 variations in the, 6-34
Displaying a monitor channel, 2-22

Displaying a Trend Link Chart During
 Logging, 5-3
Displaying the totalizer status, 2-26
Driver
 Ethernet adapter, I-20
 NDIS, I-20
 ODI, I-20
 packet, I-10
Drivers, I-9, I-20
Dynamic data exchange (DDE), 4-12, G-1

—E—

Effects of internal noise in ac
 measurements, C-1
Equation syntax, 3-21
Error and status messages, J-2
Error codes, 6-3
Ethernet adapter installation, 2-43
Ethernet Adapters, host computer, 1-15
Ethernet address, viewing of, 2-41
Ethernet cabling, 2-45, H-1
Ethernet port selection, 1-12
Excel, DDE example, G-2
Exception condition, J-2
Exporting Trend Link Data Files, 5-9
External trigger, 1-10
External trigger wiring, group
 instrument, 2-15

—F—

Features, instrument, 1-4
File format, F-1
Files
 data, 4-13
 setup, 3-11
Files, data
 configuring, 4-14
 converting from Binary to ASCII, 4-18
 converting from Binary to Trend
 Link, 4-18
Fixed-385 RTD, D-1
Frequency accuracy test, 6-14
Frequency Update, Real-Time, 5-23
Front panel controls, 2-17

Front panel indicators, 2-18

Full-disk, J-1

Fuse replacement, 6-4

—G—

General network IP address, reviewing and setting the, 2-37

General network operation, 1-12

General network socket port, reviewing and setting the, 2-36

Glossary, I-31

Grounding and common mode voltage, 2-7

Group instrument operations, 1-13

Group instrument, external trigger wiring for, 2-15

—H—

Help, Online, 4-21

Host computer Ethernet adapter installation, 2-43

Host computer Ethernet adapters, 1-15

Host computer networking parameters, setting of, 2-51

Host computer networking software, installing of, 2-50

Host computer requirements, 1-14

Host computer/instrument direct connection, 2-45

—I—

I/O, Digital, 1-8

Importing Trend Link Data Files, 5-6

Increasing data transmission and storage rate, 4-20

Increasing network speed,, 4-21

Increasing scanning rate, 4-20

Indicators

front panel, 2-18

rear panel, 2-20

Initializing the performance test setup, 6-9

Input, trigger, 1-9, 2-13

Input/Output capabilities, 2640A/2645A, A-4

Installation

driver, Ethernet adapter, I-20

driver, NDIS, ODI, I-20

Ethernet adapter, 2-43

host computer Ethernet adapter, 2-43

host computer networking

software, 2-50, 2-52

NetDAQ Logger, 2-52

Newt Networking Software, I-20, I-24

testing, 2-55

Trend Link, 2-55

Trumpet networking software, 2-53

Instrument

adding to the network, 3-5

clearing totalizer value, 4-5

deleting from the network, 3-7

unpacking and inspecting, 2-5

Instrument and host computer

interconnection, 2-45

Instrument configuration dialog box, 3-15

Instrument configuration, saving as a text file, 3-28

Instrument connector set, 1-15

Instrument description, 3-25

Instrument features and capabilities, 1-4

Instrument grounding, 2-5

Instrument icon, creating, 3-8

Instrument icon, deleting, 3-9

Instrument preparation, 2-3

Instrument, configuring, 3-15

Interconnection

instrument and host computer, 2-45

Interconnection using 10Base2 (coaxial)

wiring, 2-48

Interconnection using 10BaseT (twisted-pair)

Ethernet wiring, 2-48

Interval Trigger, 1-10

IP address for default gateway, 2-39

IP address for host computer, setting, 2-51

IP address for instrument, setting, 2-38

IP addresses and segmented networks, I-6

Isolated network operation, 1-12

Isolated network type, reviewing and setting the, 2-31

—L—

Line frequency, reviewing and setting, 2-29
 Linearization, RTD, D-1
 Logging status window, 4-7
 Logging, simulated, 4-5
 Logging, starting and stopping, 4-3
 Logging, starting automatically, 3-14

—M—

Main window, NetDAQ Logger, 3-3
 Maintenance, 6-3
 Maintenance of 2640A/2645A instruments, 6-3
 Master alarm, 1-10, 2-14
 Master alarm output test, 6-29
 Master alarm specifications, A-6
 Messages, error and status, J-2
 Monitor channel
 displaying a, 2-22
 Monitoring
 channel, 1-8
 totalizer status, 2-26
 Mx+B scaling, 1-7
 Mx+B scaling, configuring from a file, 3-25
 Mx+B, Configuring Scaling, 3-22

—N—

NetDAQ and network communication techniques, I-2
 NetDAQ Logger commands, accessing, 3-3
 NetDAQ Logger, starting, 3-3
 Netdaq.ini file, configuring the, 3-29
 Network
 adding an instrument to, 3-5
 configuring communications, 3-4
 deleting an instrument, 3-7
 troubleshooting problems, 2-58
 verifying communications, 3-7
 Network Administrator, I-2
 Network administrators, notes to, I-13
 Network cards, two in one PC, I-15
 Network communications, configuring, 3-4
 Network considerations, I-1

Network interconnection devices, I-4
 Network interface hardware (PC), I-9
 Network primer, I-3
 Network speed, increasing, 4-21
 Newt Networking Software, I-20
 Newt Networking Software, installation of, I-24
 Newt TCP/IP vs. Banyan Vines, I-22
 Newt TCP/IP vs. Microsoft LANManager, I-22
 Newt TCP/IP vs. Novell NetWare, I-21
 Newt TCP/IP vs. Windows for Workgroups, I-23, I-24
 Noise and shielding, B-2
 Noise considerations, B-1
 Note System, Using the, 5-24
 Novell NetWare, I-21
 Numbering, channel, 1-7

—O—

Online help, using, 4-21
 Open thermocouple response test, 6-16
 Operation
 preparing for, 2-3
 Optimizing performance, 4-20
 Optimizing performance for precision, 4-21
 Optimizing performance for speed, 4-20
 Options and accessories, 1-14
 Options, power-on, 2-21
 Output, trigger, 1-9, 2-14
 Overview, 1-3

—P—

Performance
 optimizing, 4-20
 optimizing for precision, 4-21
 optimizing for speed, 4-20
 Performance test, 6-6
 Physical layer wiring schemes, I-4
 Playing Back a Fast Binary (BIN) File in Trend Link, 5-5
 Playing Back a Trend Link (SET) File in Trend Link, 5-4

Playing Back an ASCII (CSV) File in Trend Link, 5-6

Positioning and rack mounting, 2-5

Power

ac, 2-6

dc, 2-7

Power source, connecting to and instrument grounding, 2-5

Power-on options, 2-21

Precision, optimizing performance for, 4-21

Preferences, Background, 5-21

Preferences, Curve, 5-18

Preparation,

instrument, 2-3

Preparing for operation, 2-3

Printing a Chart, 5-24

Printing and viewing data files, 4-18

—Q—

Quick plot, 4-11

—R—

Rack mounting, 2-5

Reading Rate, Selecting the, 3-17

Real-time clock and calendar, A-7

Real-time displays

dynamic data exchange (DDE), 4-7

instrument front panel, 4-7

logging status, 4-6

quick plot, 4-6

readings table, 4-6

spy, 4-6

Trend Link, 4-7

Real-Time Frequency Update, 5-23

Rear panel controls, 2-20

Rear panel indicators, 2-20

Replacement parts, 6-36

Replacement, fuse, 6-4

RS-232, 1-13

RTD

custom-385, D-2

fixed-385, D-1

using custom-385 with other platinum

RTDs, D-3

RTD linearization, D-1

RTD temperature accuracy test (DIN/IEC 751 RTD), 6-25

RTD temperature accuracy test (resistance) (2640A), 6-24

RTD temperature accuracy test (resistance) (2645A), 6-25

—S—

Saving an instrument configuration as a text file, 3-28

Saving the current setup, 3-11

Scaling, $Mx+B$, 1-7, 3-22

Scan queue overflows, J-1

Scanning and logging, 1-13

Scanning duration, selecting an instrument's, 4-5

Scanning rate, increasing, 4-20

Segmented networks, IP addresses and, I-6

Self-diagnostic tests, 6-3

Service, 6-35

Setting host computer networking parameters, 2-51

Setup file

starting NetDAQ Logger with, 3-13

Setup files, 3-11

opening, 3-12

Shielded wiring, 2-11

Shielding considerations, B-1

Simulated logging, 4-5

Specifications, A-1

2640A, A-7

2645A, A-17

2-Wire resistance measurement (2645A), A-22

2-Wire resistance measurement (2640A), A-13

4-Wire resistance measurement (2640A), A-12

4-Wire resistance measurement (2645A), A-21

4-Wire RTD per ITS-1990 measurement (2645A), A-22

ac voltage measurement (2640A), A-9

- ac voltage measurement (2645A), A-19
 - combined 2640A/2645A, A-1
 - dc voltage measurement (2640A), A-8
 - dc voltage measurement (2645A), A-17
 - frequency measurement (2640A), A-16
 - frequency measurement (2645A), A-25
 - general 2640A/2645A, A-1
 - RTD's 2-Wire per ITS-1990 measurement specifications (2640A), A-14
 - RTD's 4-Wire, per ITS-1990 measurement (2640A), A-13
 - thermocouple per ITS-1990 measurement (2640A), A-14
 - thermocouple per ITS-1990 measurement (2645A), A-23
 - Speed, optimizing performance for, 4-20
 - Spy window,, 4-9
 - Starting and stopping logging, 4-3
 - Starting logging automatically, 3-14
 - Starting NetDAQ Logger, 3-3
 - Starting NetDAQ Logger with a setup file, 3-13
 - Starting or stopping all instruments, 4-4
 - Starting or stopping group instrument, 4-4
 - Static versus dynamic measurements, B-1
 - Status and error messages, J-2
 - Subnet mask and default gateway, reviewing and setting the, 2-38
 - System operation, 1-11
- T—**
- TCP/IP protocol stack, I-11
 - TCP/IP software
 - Banyan Vines, I-22
 - Microsoft LANManager, I-22
 - Novell NetWare, I-21
 - Windows for Workgroups, I-11, I-23
 - Windows NT, I-11
 - Windows95, I-11
 - Test
 - 2-Wire resistance accuracy (2640A), 6-17
 - 2-Wire resistance accuracy (2645A), 6-18
 - 4-Wire resistance accuracy (2640A), 6-20
 - 4-Wire resistance accuracy (2645A), 6-23
 - analog channel integrity, 6-15
 - computed channel integrity, 6-15
 - digital I/O output, 6-26
 - digital input, 6-27
 - digital input/output, 6-26
 - frequency accuracy, 6-14
 - master alarm output, 6-29
 - open thermocouple response, 6-16
 - performance, 6-6
 - thermocouple temperature accuracy, 6-16
 - totalizer, 6-28
 - totalizer count, 6-28
 - totalizer sensitivity, 6-28
 - trigger input, 6-30
 - trigger output, 6-30
 - Test setup
 - initializing the performance, 6-9
 - Test setup, configuring the, 6-6
 - Testing and troubleshooting, 2-55
 - Testing the Installation, 2-55
 - Text file, saving an instrument configuration as, 3-28
 - Thermocouple temperature accuracy test, 6-16
 - Token ring networks, I-19
 - Totalizer, 1-9, 2-12
 - 2640A/2645A, A-7
 - Totalizer count test, 6-28
 - Totalizer sensitivity test, 6-28
 - Totalizer tests, 6-28
 - Totalizer value, clearing instrument, 4-5
 - Trend Link
 - Displaying a Chart During Logging, 5-3
 - Exporting Data Files, 5-9
 - Importing Data Files, 5-6
 - Playing Back a Fast Binary File, 5-5
 - Playing Back a Trend Link file, 5-4
 - Playing Back an ASCII File, 5-6

Using the Menus, 5-15
Trend Link Chart, Getting the Right Look
for your, 5-12
Trend Link for Fluke, Using, 5-3
Trend Link, Installation of, 2-55
Trigger in, A-5
Trigger input, 1-9, 2-13
Trigger input test, 6-30
Trigger out, A-6
Trigger output, 1-9, 2-14
Trigger output test, 6-30
Trigger, alarm, 1-10
Trigger, external, 1-10
Troubleshooting, I-16
Troubleshooting network problems, 2-58
Troubleshooting, testing and, 2-55
True-RMS measurements, C-1
Trumpet networking software,
installation, 2-53

—U—

Universal input module connections, 2-7

Unpacking and inspecting the instrument, 2-5
Using Excel, DDE example of, G-2
UTP cables, H-1

—V—

Variations in the display, 6-34
Verifying network communications, 3-7
Viewing and printing a data file, 4-18
Viewing the instrument Ethernet
address, 2-41
Volts ac accuracy test, 6-13
Volts dc accuracy test (2640A), 6-11
Volts dc accuracy test (2645A), 6-12

—W—

Waveform comparison (true rms vs average
responding), C-2
Windows for Workgroups, I-23
WINSOCK DLL and application
programming interface, I-13
Wiring, shielded, 2-11

Instrument Parameter Record (Isolated Network)

Instrument BCN: _____ Note: _____

Instrument BCN: _____ Note: _____

Instrument BCN: _____ Note: _____

Instrument BCN: _____ Note: _____

Instrument BCN: _____ Note: _____

Instrument BCN: _____ Note: _____

Instrument BCN: _____ Note: _____

Instrument BCN: _____ Note: _____

Instrument BCN: _____ Note: _____

Instrument BCN: _____ Note: _____

Instrument BCN: _____ Note: _____

Instrument BCN: _____ Note: _____

Instrument BCN: _____ Note: _____

Instrument BCN: _____ Note: _____

Instrument BCN: _____ Note: _____

Instrument BCN: _____ Note: _____

Instrument BCN: _____ Note: _____

Instrument BCN: _____ Note: _____

Instrument BCN: _____ Note: _____

Instrument BCN: _____ Note: _____

Instrument BCN: _____ Note: _____

Instrument BCN: _____ Note: _____

Instrument BCN: _____ Note: _____

Instrument BCN: _____ Note: _____

Instrument BCN: _____ Note: _____

Instrument BCN: _____ Note: _____

Instrument BCN: _____ Note: _____

Instrument BCN: _____ Note: _____

Instrument Parameter Record (General Network)

Instrument BCN: _____ IP Address: _____ . _____ . _____ . _____
Subnet Mask: _____ . _____ . _____ . _____
Default Gateway: _____ . _____ . _____ . _____
Ethernet Address: _____ : _____ : _____ : _____ : _____ : _____
Note: _____

Instrument BCN: _____ IP Address: _____ . _____ . _____ . _____
Subnet Mask: _____ . _____ . _____ . _____
Default Gateway: _____ . _____ . _____ . _____
Ethernet Address: _____ : _____ : _____ : _____ : _____ : _____
Note: _____

Instrument BCN: _____ IP Address: _____ . _____ . _____ . _____
Subnet Mask: _____ . _____ . _____ . _____
Default Gateway: _____ . _____ . _____ . _____
Ethernet Address: _____ : _____ : _____ : _____ : _____ : _____
Note: _____

Instrument BCN: _____ IP Address: _____ . _____ . _____ . _____
Subnet Mask: _____ . _____ . _____ . _____
Default Gateway: _____ . _____ . _____ . _____
Ethernet Address: _____ : _____ : _____ : _____ : _____ : _____
Note: _____

Instrument BCN: _____ IP Address: _____ . _____ . _____ . _____
Subnet Mask: _____ . _____ . _____ . _____
Default Gateway: _____ . _____ . _____ . _____
Ethernet Address: _____ : _____ : _____ : _____ : _____ : _____
Note: _____

Instrument Parameter Record (General Network)

Instrument BCN: _____ IP Address: _____ . _____ . _____ . _____
Subnet Mask: _____ . _____ . _____ . _____
Default Gateway: _____ . _____ . _____ . _____
Ethernet Address: _____ : _____ : _____ : _____ : _____ : _____
Note: _____

Instrument BCN: _____ IP Address: _____ . _____ . _____ . _____
Subnet Mask: _____ . _____ . _____ . _____
Default Gateway: _____ . _____ . _____ . _____
Ethernet Address: _____ : _____ : _____ : _____ : _____ : _____
Note: _____

Instrument BCN: _____ IP Address: _____ . _____ . _____ . _____
Subnet Mask: _____ . _____ . _____ . _____
Default Gateway: _____ . _____ . _____ . _____
Ethernet Address: _____ : _____ : _____ : _____ : _____ : _____
Note: _____

Instrument BCN: _____ IP Address: _____ . _____ . _____ . _____
Subnet Mask: _____ . _____ . _____ . _____
Default Gateway: _____ . _____ . _____ . _____
Ethernet Address: _____ : _____ : _____ : _____ : _____ : _____
Note: _____

Instrument BCN: _____ IP Address: _____ . _____ . _____ . _____
Subnet Mask: _____ . _____ . _____ . _____
Default Gateway: _____ . _____ . _____ . _____
Ethernet Address: _____ : _____ : _____ : _____ : _____ : _____
Note: _____

Instrument Parameter Record (General Network)

Instrument BCN: _____ IP Address: _____ . _____ . _____ . _____
Subnet Mask: _____ . _____ . _____ . _____
Default Gateway: _____ . _____ . _____ . _____
Ethernet Address: _____ : _____ : _____ : _____ : _____ : _____
Note: _____

Instrument BCN: _____ IP Address: _____ . _____ . _____ . _____
Subnet Mask: _____ . _____ . _____ . _____
Default Gateway: _____ . _____ . _____ . _____
Ethernet Address: _____ : _____ : _____ : _____ : _____ : _____
Note: _____

Instrument BCN: _____ IP Address: _____ . _____ . _____ . _____
Subnet Mask: _____ . _____ . _____ . _____
Default Gateway: _____ . _____ . _____ . _____
Ethernet Address: _____ : _____ : _____ : _____ : _____ : _____
Note: _____

Instrument BCN: _____ IP Address: _____ . _____ . _____ . _____
Subnet Mask: _____ . _____ . _____ . _____
Default Gateway: _____ . _____ . _____ . _____
Ethernet Address: _____ : _____ : _____ : _____ : _____ : _____
Note: _____

Instrument BCN: _____ IP Address: _____ . _____ . _____ . _____
Subnet Mask: _____ . _____ . _____ . _____
Default Gateway: _____ . _____ . _____ . _____
Ethernet Address: _____ : _____ : _____ : _____ : _____ : _____
Note: _____

Instrument Parameter Record (General Network)

Instrument BCN: _____ IP Address: _____ . _____ . _____ . _____
Subnet Mask: _____ . _____ . _____ . _____
Default Gateway: _____ . _____ . _____ . _____
Ethernet Address: _____ : _____ : _____ : _____ : _____ : _____
Note: _____

Instrument BCN: _____ IP Address: _____ . _____ . _____ . _____
Subnet Mask: _____ . _____ . _____ . _____
Default Gateway: _____ . _____ . _____ . _____
Ethernet Address: _____ : _____ : _____ : _____ : _____ : _____
Note: _____

Instrument BCN: _____ IP Address: _____ . _____ . _____ . _____
Subnet Mask: _____ . _____ . _____ . _____
Default Gateway: _____ . _____ . _____ . _____
Ethernet Address: _____ : _____ : _____ : _____ : _____ : _____
Note: _____

Instrument BCN: _____ IP Address: _____ . _____ . _____ . _____
Subnet Mask: _____ . _____ . _____ . _____
Default Gateway: _____ . _____ . _____ . _____
Ethernet Address: _____ : _____ : _____ : _____ : _____ : _____
Note: _____

Instrument BCN: _____ IP Address: _____ . _____ . _____ . _____
Subnet Mask: _____ . _____ . _____ . _____
Default Gateway: _____ . _____ . _____ . _____
Ethernet Address: _____ : _____ : _____ : _____ : _____ : _____
Note: _____

General Network Parameter Record

Socket Port: _____ (default is 4369)

.....

Host Computer General Network Parameter Record

Host Computer: _____

IP Address: _____ . _____ . _____ . _____

Subnet Mask: _____ . _____ . _____ . _____

Host Name: _____

Domain Name: _____

Default Gateway: _____ . _____ . _____ . _____

(only if routed network)

I/O Address: _____

Interrupt: _____

Ethernet Address: ____ : ____ : ____ : ____ : ____ : ____

.....

Host Computer: _____

IP Address: _____ . _____ . _____ . _____

Subnet Mask: _____ . _____ . _____ . _____

Host Name: _____

Domain Name: _____

Default Gateway: _____ . _____ . _____ . _____

(only if routed network)

I/O Address: _____

Interrupt: _____

Ethernet Address: ____ : ____ : ____ : ____ : ____ : ____

General Network Parameter Record

Socket Port: _____ (default is 4369)

.....

Host Computer General Network Parameter Record

Host Computer: _____

IP Address: _____ . _____ . _____ . _____

Subnet Mask: _____ . _____ . _____ . _____

Host Name: _____

Domain Name: _____

Default Gateway: _____ . _____ . _____ . _____

(only if routed network)

I/O Address: _____

Interrupt: _____

Ethernet Address: ____ : ____ : ____ : ____ : ____ : ____

.....

Host Computer: _____

IP Address: _____ . _____ . _____ . _____

Subnet Mask: _____ . _____ . _____ . _____

Host Name: _____

Domain Name: _____

Default Gateway: _____ . _____ . _____ . _____

(only if routed network)

I/O Address: _____

Interrupt: _____

Ethernet Address: ____ : ____ : ____ : ____ : ____ : ____