

**FLUKE®**

# **Fluke 43B**

## Power Quality Analyzer

### Applications Guide

April 2001

© 2001 Fluke Corporation, All rights reserved. Printed in The Netherlands.  
All product names are trademarks of their respective companies.

## **Table of Contents**

<b>Chapter</b>	<b>Title</b>	<b>Page</b>
	Working Safely.....	1
	How to use this Manual.....	2
	Conventions Used.....	2
	Resetting the Fluke 43B.....	4
<b>1</b>	<b>Basic Measurements .....</b>	<b>5</b>
	Introduction .....	5
	Measuring Line Voltage .....	6
	Measuring Current .....	7
	Line Voltage and Current Simultaneously.....	8
	Measuring Line Voltage and Current .....	8
	Recording Line Voltage and Current.....	9
	Testing Continuity .....	11
	Measuring Resistance .....	12
	Measuring Capacitance .....	13
	Testing a Diode.....	14
<b>2</b>	<b>Receptacle Branch Circuits .....</b>	<b>15</b>
	Troubleshooting Electrical Distribution Systems.....	15
	Detecting Transients (Phase to Neutral).....	16
	Monitoring Rapid Voltage Fluctuations .....	19
	Measuring Voltage Harmonics .....	21
	Measuring Current Harmonics .....	22
	Measuring the Load on a Transformer.....	24
	Recording the Load on a Transformer .....	26
	Measuring K-factor.....	29
<b>3</b>	<b>Lighting Loads .....</b>	<b>31</b>
	Introduction .....	31
	Measuring Current Harmonics .....	32
	Measuring Power on Single Phase Loads .....	33
	Measuring Surge Current.....	34

<b>4</b>	<b>Motor Loads</b> .....	<b>37</b>
	Introduction .....	37
	Induction Motors.....	38
	Checking Voltage Imbalance .....	38
	Checking Current and Current Imbalance.....	40
	Measuring 3-Phase Balanced Power .....	42
	Measuring Peak and Inrush Current .....	44
	Measuring Power Factor of 3-Phase Motors .....	47
	Grounded Y-Connection with Balanced Load.....	47
	Delta connection or floating systems.....	48
	Measuring Voltage Harmonics .....	50
	Adjustable Speed Drives.....	51
	Checking Current on Phases .....	51
	Measuring Fundamental of Motor Voltage .....	52
	Measuring Frequency of Motor Current.....	53
<b>5</b>	<b>Scope Mode</b> .....	<b>55</b>
	Introduction .....	55
	Basic One Channel Measurement .....	56
	Set Up Selection .....	57
	Viewing Signal Details.....	59
	Triggering.....	61
	Return to Auto Mode .....	62
	Dual Channel Measurement .....	63
	Single Mode .....	67
<b>6</b>	<b>Handling Screens and Data</b> .....	<b>67</b>
	Introduction .....	67
	Saving Screens .....	68
	Viewing and Deleting screens.....	68
	Printing Screens.....	70
	Creating Reports.....	71
	Recording Harmonics over Time.....	72
<b>7</b>	<b>Definitions</b> .....	<b>75</b>
	<b>Index</b>	



## Working Safely

### Warning

**To avoid electric shock and/or equipment damage, use caution when connecting test leads to live components. The jaws of alligator clips can create a short circuit between closely spaced live parts. Avoid making connections to feeder conductors or bus bars at elevated potentials. Whenever possible, make connections to the output side of a circuit breaker, which can provide better short circuit protection.**

- Follow all legal requirements. Follow all instructions in the manuals. Obey posted instructions.
- Never assume that a circuit is de-energized. Check it first.
- Always set up the measurement first, then connect the test leads to the circuit.
- Use only test leads and test lead adapters supplied with the Fluke 43B (or safety-designed equivalents as specified in the accessory list, see Chapter 2 of the Users Manual).
- Never use adapters or test leads that have exposed metal parts or insufficient voltage rating.
- Remove all test leads that are not in use.
- Make connections to the instrument first, before connecting leads to a live circuit.
- Connect the ground lead first, then the voltage leads and the current probe. Disconnect in reverse order.
- Route your test leads carefully.

## How to use this Manual

The applications in this manual are grouped in five chapters.

**Chapter 1** contains basic measurements.

Start with this chapter to get acquainted with the Fluke 43B and with this manual.

**Chapter 2** contains applications related to problems with receptacle loads and transformers.

**Chapter 3** contains applications related to lighting systems.

**Chapter 4** focusses completely on motors and motor drives.

**Chapter 5** explains the scope functions.

To find an application related to the functions in the main menu, look up the page numbers in the figure.

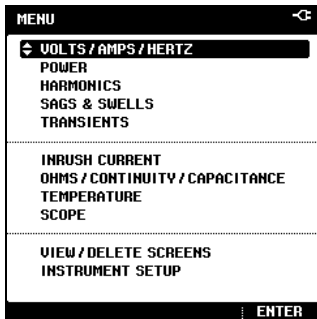

## Conventions Used

- G** Ground
- N** Neutral
- 1** Phase 1
- 2** Phase 2
- 3** Phase 3

### VOLTS / AMPS / HERTZ

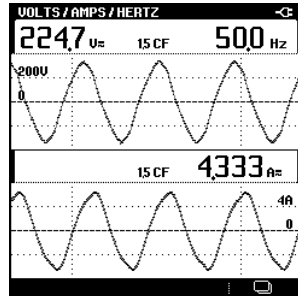

Pages: 6,7,8,38,40,51,53

### POWER

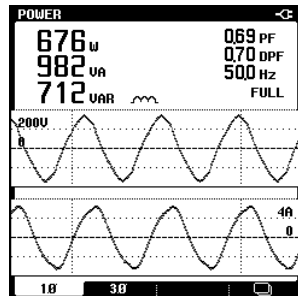

Pages: 24,33,47,48

### HARMONICS

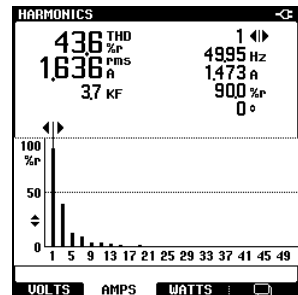

Pages: 21,22,29,32,50,52

**SAGS & SWELLS**

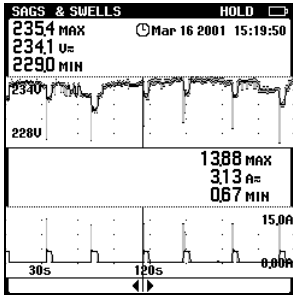

Pages: 9,19

**OHMS / CONTINUITY / CAPACITANCE**

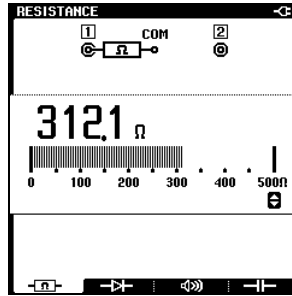

Pages: 11,12,13,14

**TRANSIENTS**

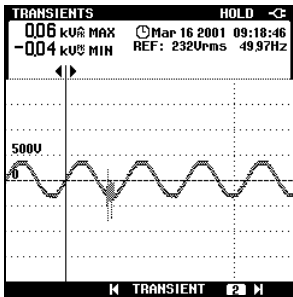

Page: 16

**RECORD**

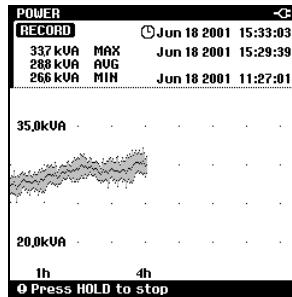

Page: 26

**INRUSH CURRENT**

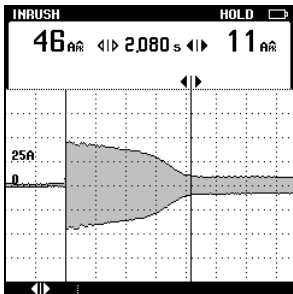

Pages: 34,44

**SCOPE**

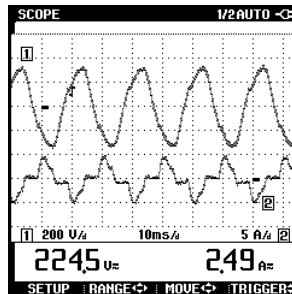



Page: 55

## Resetting the Fluke 43B

To restore the Fluke 43B to its factory settings and return to the opening screen, reset the Fluke 43B. Resetting does not clear screen memories.

Turn the Fluke 43B off and proceed as follows:

-  Press and hold.
-  Press and release.

The Fluke 43B turns on, and you should hear a double beep, indicating that the reset operation was successful.

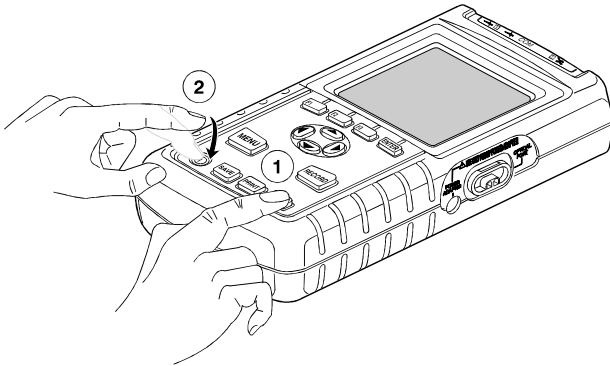

**Figure 1. Resetting the Fluke 43B**

-  Release the HOLD key.

The opening screen with default settings appears on the display.

*Note*

To learn how to setup the Fluke 43B, see: “Introducing the Fluke 43B” in Chapter 1 of the Users Manual.

-  Continue.

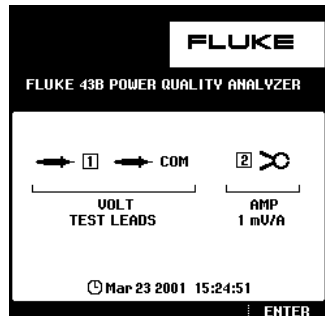



# **Chapter 1**

## **Basic Measurements**

### ***Introduction***

This section provides easy-to-do measurements which you can perform almost anywhere. Begin with these examples to get started with the Fluke 43B.

#### *Note*

*It is a good idea to reset the Fluke 43B before you start a new application. This way, you always start from the same setup.*

## Measuring Line Voltage

Determine whether the voltage level, voltage waveform, and frequency from an outlet are correct.

1  Open the main menu.

2   → 

3 Make connections as shown below:

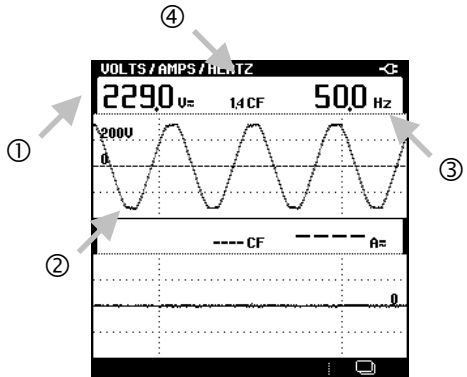
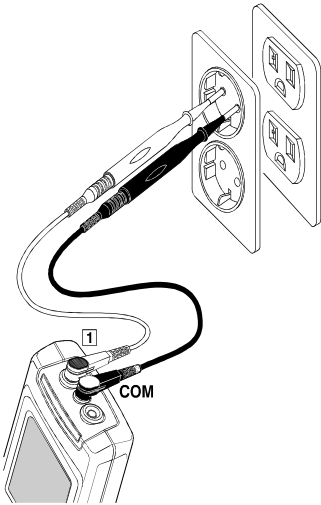





- ① The rms voltage should be close to the nominal voltage, for example 120V or 230V.
- ② The waveform should be smooth and sinusoidal.
- ③ The frequency should be close to 50 or 60 Hz.
- ④ The Crest Factor CF is an indication of the amount of distortion. A high Crest factor means high distortion.

*Note*

*Nominal voltages and frequencies differ by country.*

## Measuring Current

Determine how the current from an outlet is supplied to a load, in this example, a hair dryer.

- 1  Open the main menu.
- 2   → 
- 3 Make connections as shown below:

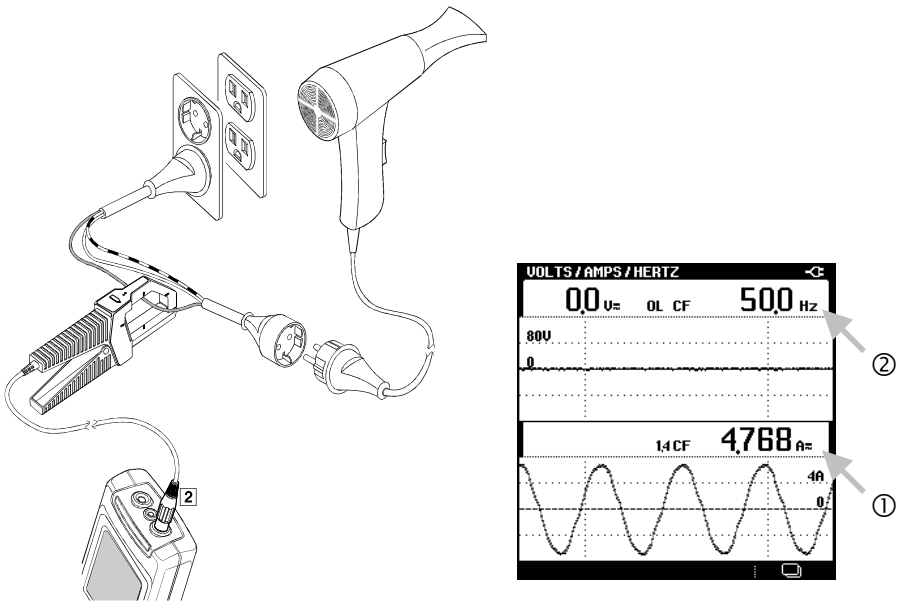





- 4 Turn on the hair dryer.
- ① When the hair dryer is turned on, the current from the outlet increases.
  - ② Notice that without test leads connected, the Fluke 43B measures the frequency of the current signal.

## Line Voltage and Current Simultaneously

### Measuring Line Voltage and Current

Determine the influence of the load current on the voltage.

- 1  Open the main menu.
- 2   → 
- 3 Make connections as shown below:

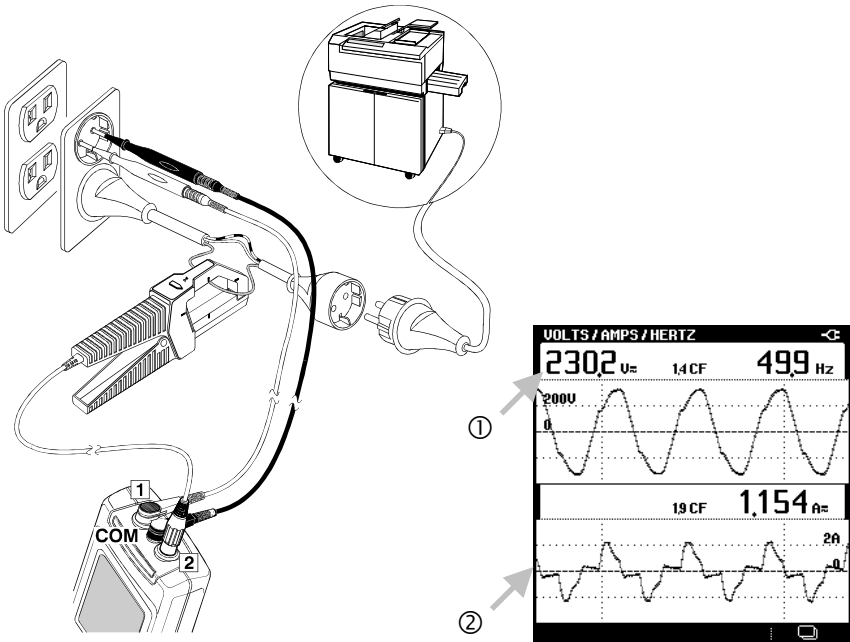

- ① The rms voltage should stay within reasonable limits.
- ② The current increases when the copier is warming up or making a copy.





#### Note

*In stead of a copier, you can also use other loads of 1000W or more.*

## **Recording Line Voltage and Current**

By recording the voltage and current, you can establish a possible relation between the two. For recording voltage and current, always use **SAGS & SWELLS**. Basically it does the same as the **RECORD** key, but it can record faster fluctuations. Use the **RECORD** key for all other combinations of readings you want to record.

Use the copier again and proceed as follows:

- 1  Open the main menu.
- 2   



Select the desired record time:

- 3   
- 4   

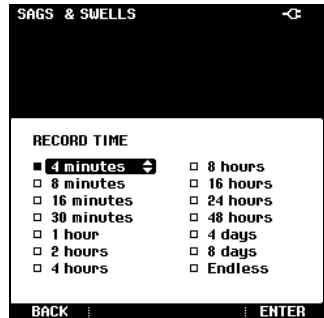

*Note*

*Choosing shorter recording times makes it easier to see details of events on the screen.*



The Fluke 43B starts recording sags and swells.

Wait for 4 minutes... or press the **HOLD** key to stop the recording.

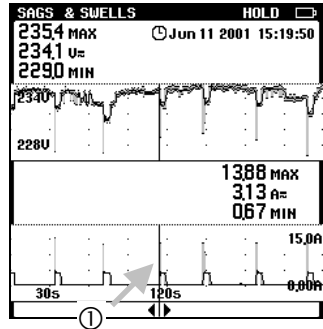
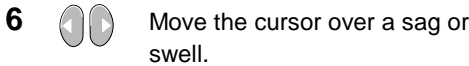
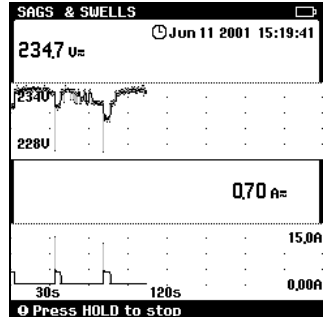





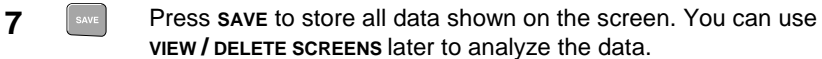

① In this example, the high peak current from the copier caused the voltage to drop (voltage sag).

In general, if you find voltage sags, the next step is to look for devices which may cause them. Poor connections or long conductors increase the effect.



## Testing Continuity

Check whether a fuse is broken or open by checking continuity. In general, you can check any circuit for open connection.

- 1  Open the main menu.
- 2   
- 3  Select  (continuity)
- 4 Make connections as shown below:

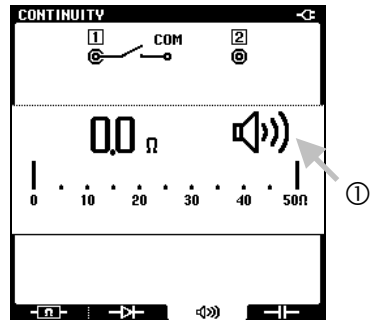
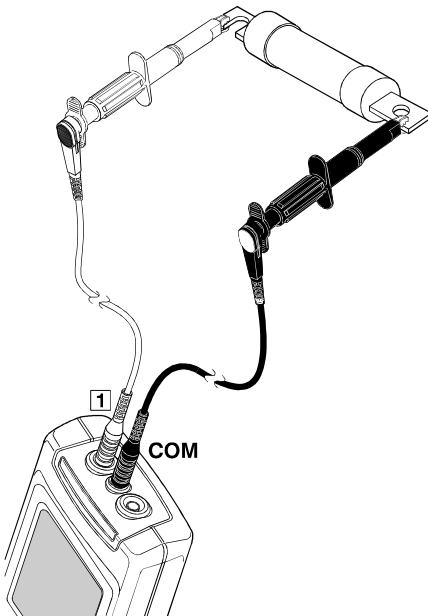





- ① When the Fluke 43B beeps and shows a beep-icon, the fuse is closed.  
When the Fluke 43B shows **OL** (Over Load), the fuse is open.

### Note

When the resistance is high ( $>30\Omega$ ), an open circuit is indicated, otherwise the circuit is considered to be closed (0 -  $30\Omega$ ).

## Measuring Resistance

Measure the resistance of a relay coil (or a resistor).

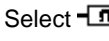
- 1  Open the main menu.
- 2   → 
- 3  Select  (ohm)
- 4 Make connections as shown below:

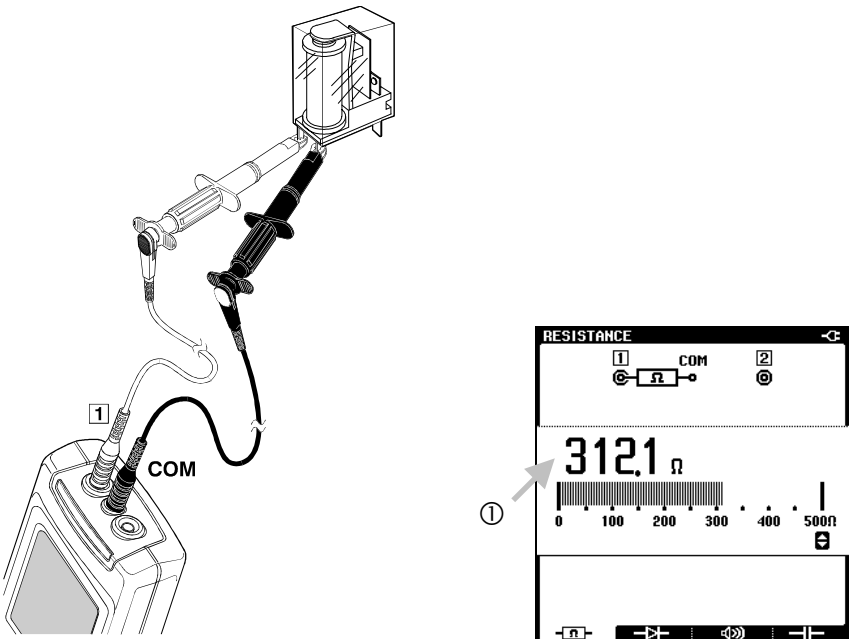







- ① Observe the resistance. A typical reading on the display should be between about 150 and 500Ω. If the reading seems too high, test a known good device and compare the measured values of both devices.



## Measuring Capacitance

Measure the capacitance of a capacitor ( $\leq 500 \mu\text{F}$ ).



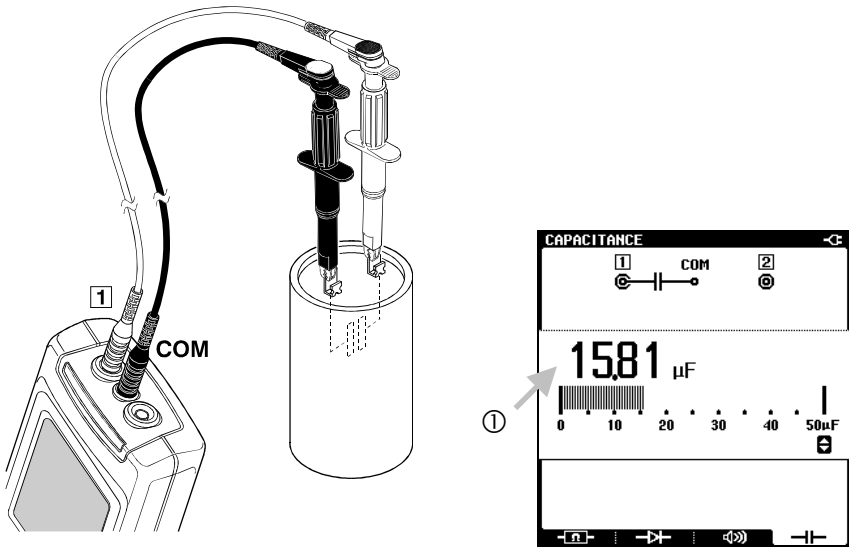



- 1  Open the main menu.
- 2   
- 3  Select  (capacitance)
- 4 Make connections as shown below:



- ① Observe the capacitance. The display shows the measured value of the capacitor. Compare the measured value with the value indicated on the capacitor.

## Testing a Diode

Check a diode in both forward direction and reverse direction. Useful for checking whether the diodes in a rectifier are still intact.

- 1  Open the main menu.
- 2   → 
- 3  Select  (diode)
- 4 Make connections as shown below:

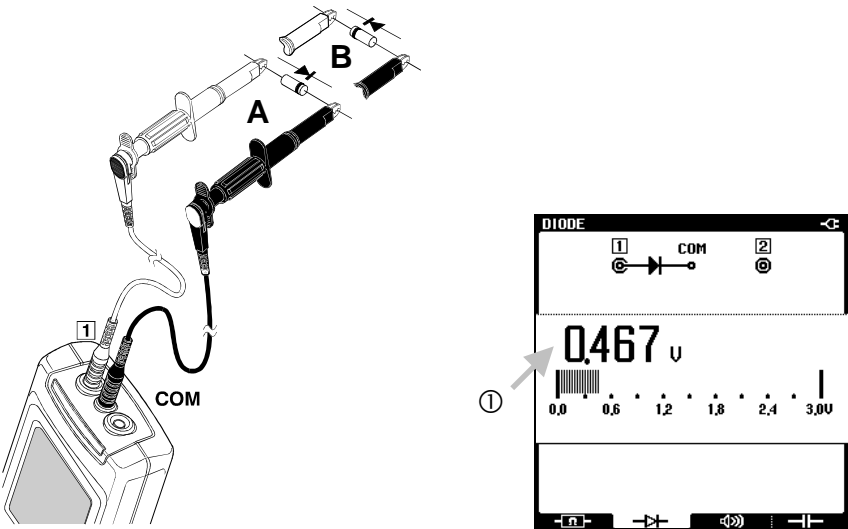

- ① Observe the voltage in forward direction (A). It should read about 0.5V.  
Now turn the diode in reverse direction (B) and look at the display again.
- The Fluke 43B should display **OL** (Over Load), indicating a very high resistance. If not, the diode is faulty and should be replaced.

# Chapter 2

## Receptacle Branch Circuits

### Troubleshooting Electrical Distribution Systems

The most efficient way to troubleshoot electrical systems, is to begin at the load and work towards the building's service entrance. Measurements are taken along the way to isolate faulty components or loads. This chapter describes typical measurements for troubleshooting problems on receptacle branch circuits.

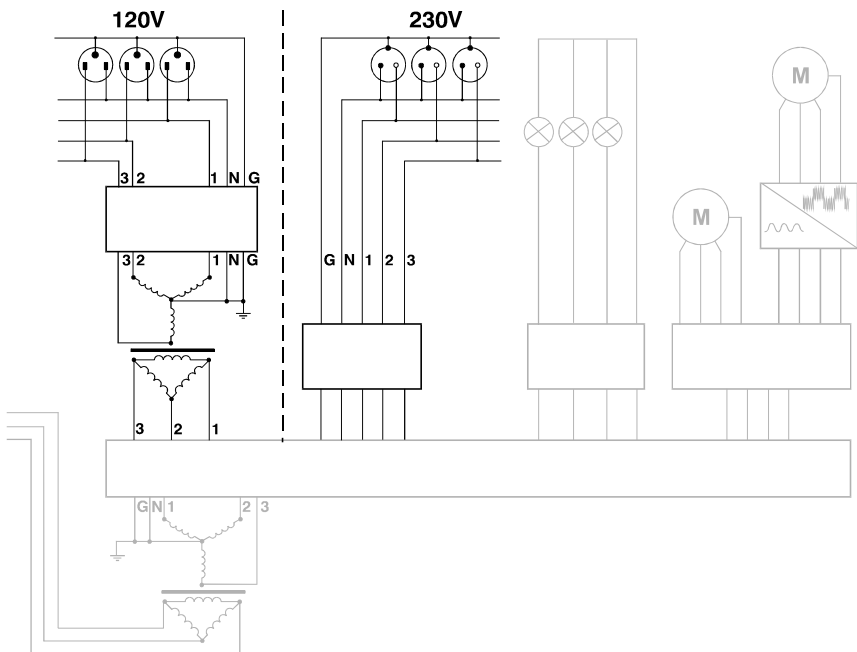









Figure 2. Distribution System: Receptacle Loads

## Detecting Transients (Phase to Neutral)

Disturbances in a distribution system may cause malfunctioning of many types of devices. For example, resetting computers or false tripping breakers. Events occur occasionally, making it necessary to monitor the system for a period of time to find them.

You may look for voltage transients (impulses or spikes) when, for example, computers are resetting spontaneously.

- 1  Open the main menu.
- 2   → 
- 3   → 

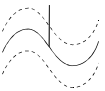

*A transient is detected when it crosses the boundaries of the waveform.*

Select a voltage change of 50%.

*If the normal rms voltage is 120V, transients which deviate more than 60V from the normal voltage, are detected. (50% of 120V = 60V).*

- 4   → 

5 Make connections as shown below:

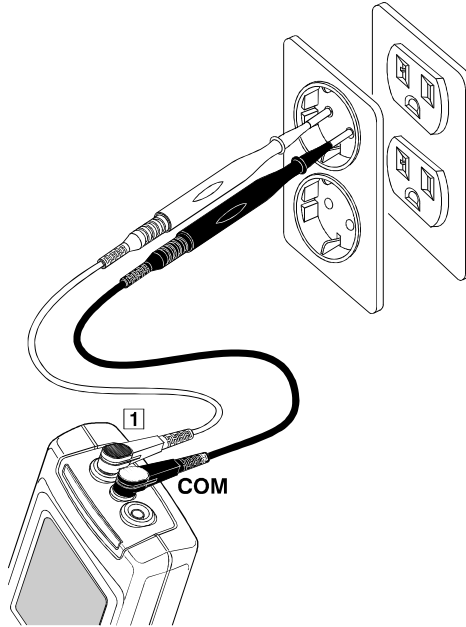

6    

The Fluke 43B starts capturing up to 40 transients.

7  Press **HOLD** to stop capturing transients.

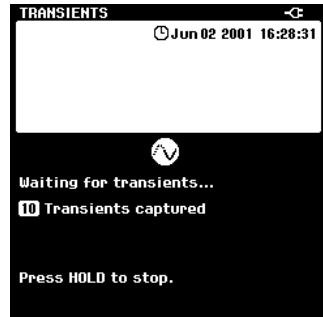

You can now browse through the screens which contain transients:



Choose a screen you want to analyze.

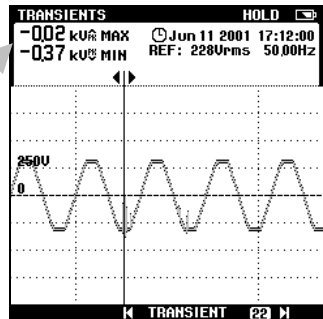
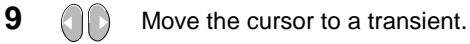

① Observe the measured maximum or minimum peak voltage.



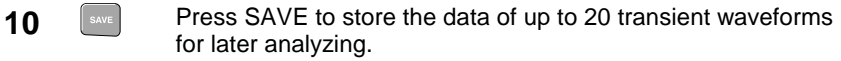

If the peak voltage reading indicates **OL** (Over Load), repeat the measurement at a higher value for **VOLTAGE CHANGE**.



## Monitoring Rapid Voltage Fluctuations

Rapid voltage fluctuations in a distribution system may cause lights to flicker. Deviations of only a few cycles (waveform periods) may result in visible dimming.

The **SAGS & SWELLS** function measures the rms voltage over each cycle and displays deviations.

- 1  Open the main menu.
- 2   → 

Select the desired recording time:

- 3   → 
- 4   → 



- 5 Make connections as shown below:

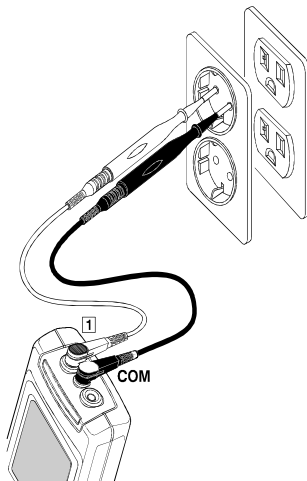



The Fluke 43B starts recording sags and swells.

Wait for 4 minutes... or press the HOLD key to stop the recording.

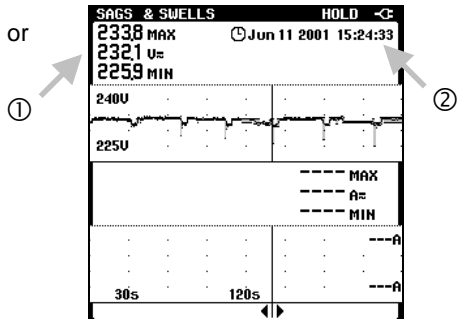
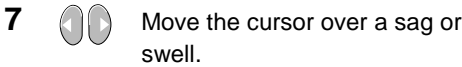
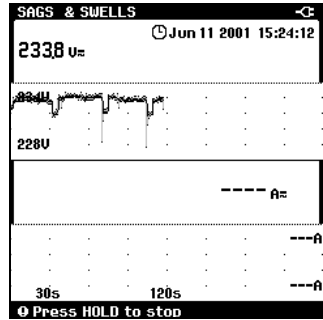

- ① Observe the rms voltage of the sag or swell: in case of a sag, read the minimum voltage, in case of a swell the maximum voltage.
- ② Observe the time when it occurred.

Determine where the sag or swell came from:

When the voltage decreases and the current does not change or only slightly, the source of the problem is **upstream**.



When the voltage decreases while the current increases, there is some load that causes the voltage to drop. The source of the problem is **downstream**.







### Tip

If you find sags or swells, search for equipment which may cause them, such as large motor startups, welders, etc.



## Measuring Voltage Harmonics

You can perform a quick check on harmonics in a power distribution system by measuring the Total Harmonic Distortion on the voltage.



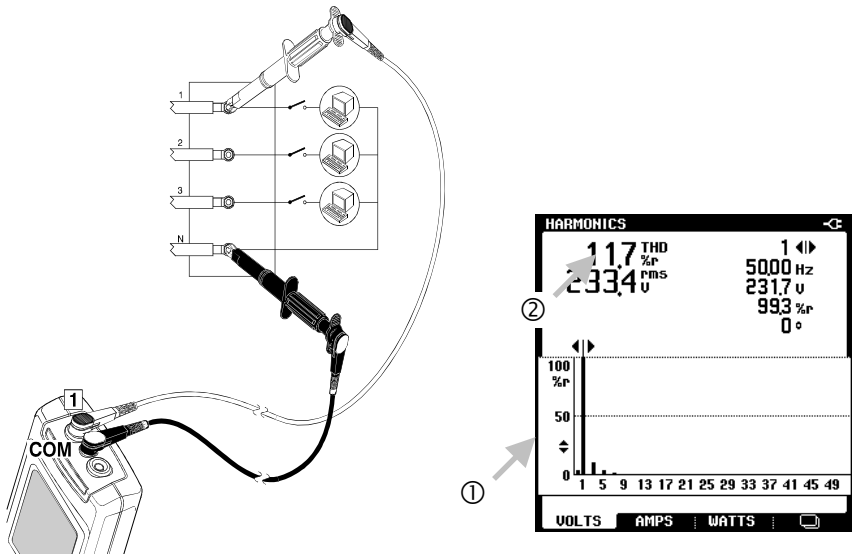

- 1  Open the main menu.
- 2   → 
- 3  Select VOLTS.
- 4 Make connections as shown below:





- (5)  Scale the harmonics spectrum screen to see more or less details.
- ① Look at the harmonics spectrum screen. Check the spectrum for severe harmonics.
- ② If the THD is lower than 5%, the voltage distortion level is probably acceptable.

## Measuring Current Harmonics

Non-linear loads produce current harmonics which may cause voltage distortion.

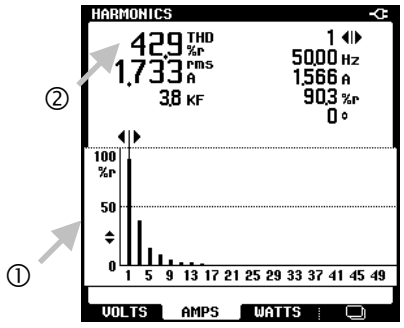
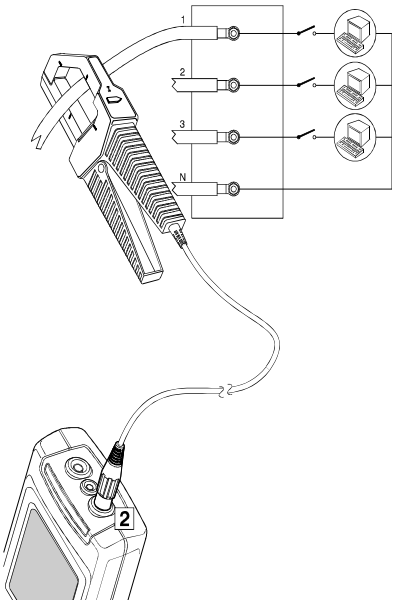
- 1  Open the main menu.
- 2   → 
- 3  Select AMPS.
- 4 Make connections as shown below:



- (5)  Scale the harmonics spectrum screen to see more or less details.

- ① Look at the harmonics spectrum screen. Check the spectrum for severe harmonics.
- ② Read the THD. It indicates the harmonic distortion on the current signal. Usually, the current signal can tolerate more harmonics than the voltage signal.

### **Tip**

Measure harmonic currents at the point of common coupling to check whether the THD and individual harmonics comply with national standards (like IEEE-519). It is incorrect to apply such standards to specific loads.

Zero-sequence harmonics (3rd, 9th, 15th, ...) add in neutral conductors or bus bars. This can cause overheating in neutral wires.

By measuring current harmonics at several places in a distribution system, you can track the harmonic source. The closer you get to the source, the more severe the current THD will be.

With FlukeView® software you can record Harmonics over time and export data to popular spreadsheet programs such as Excel.

## Measuring the Load on a Transformer

Measure the total kVA on all three phases to check the load on a transformer.

1  Open the main menu.

2   → 

3 Make connections as shown below:

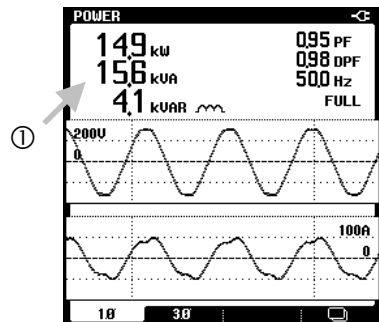
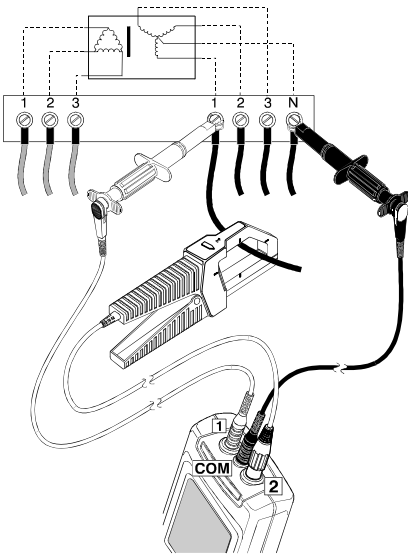

- ① Look at the kVA reading. It shows the apparent power on phase 1. Write down the value ( $kVA_1$ ).
- ② The symbol of a Capacitor or an Inductor is shown to indicate capacitive or inductive loads.
- 4 Repeat the measurement on phase 2 and phase 3 (keep the black test lead connected to the neutral). Write down the values for  $kVA_2$  and  $kVA_3$  and calculate  $kVA_{TOTAL}$





$\underline{\hspace{2cm}} \text{ kVA}_1 + \underline{\hspace{2cm}} \text{ kVA}_2 + \underline{\hspace{2cm}} \text{ kVA}_3 = \underline{\hspace{2cm}} \text{ kVA}_{TOTAL}$
---

Compare this result with the transformer kVA rating. If the result is close to, or over the nameplate reading of the transformer, reduce the load on the

transformer. If this is impossible, the transformer should be replaced by a unit with a higher kVA (or K-rating if harmonic currents are present).

## **Recording the Load on a Transformer**

By recording the kVA during several hours, you can find out if there are specific moments during the day that the transformer may become overloaded.

- 1  Open the main menu.
- 2  **POWER** 
- 3  Open the RECORD menu.





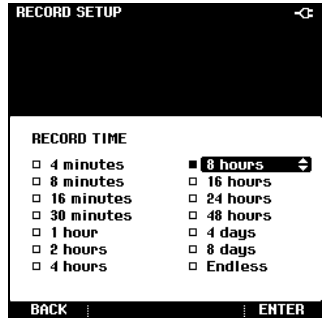

Select the desired record time:

- 4  **RECORD TIME** 
- 5  **8 hours** 



Select the first reading to record:

- 6  **FIRST READING** 
- 7  **VA** 



Repeat step 6 and 7 to select the second reading, or continue with step 8.

Use the power adapter to prevent automatic shutdown during recording.



The Fluke 43B starts recording the kVA reading.

Wait for 8 hours... or press the HOLD key to stop the recording.

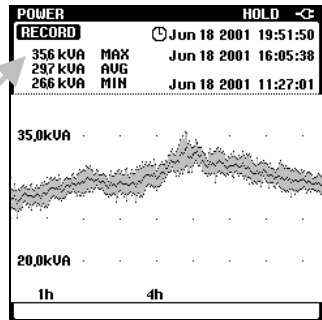
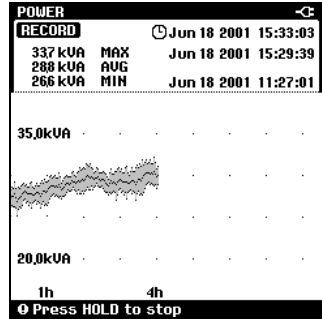

①

① Look for high kVA-readings during the day.

**9**  Select **CURSOR**

**10**  Position the cursor on the event of interest in order to get measurements from the corresponding time.

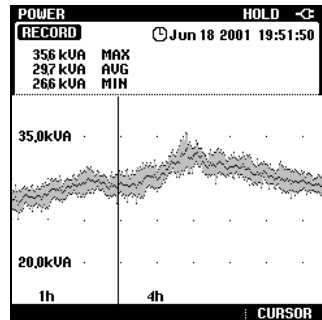

*Note*

*Note that the kVA of only 1 phase was recorded. Record the other two phases before drawing conclusions.*





**Tip**

Press SAVE to save the screen in memory for later documenting and analysis of the data.



## Measuring K-factor

K-factor is an indication of the amount of harmonic currents. High harmonic orders influence the K-factor more than low harmonic orders.

- 1  Open the main menu.
- 2   → 
- 3  Select AMPS.
- 4 Make connections as shown below. Measure the K-factor under full load.

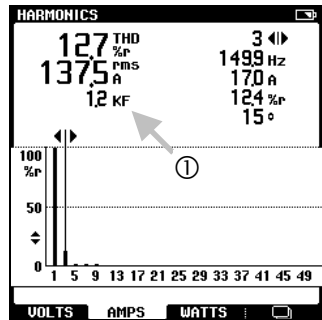
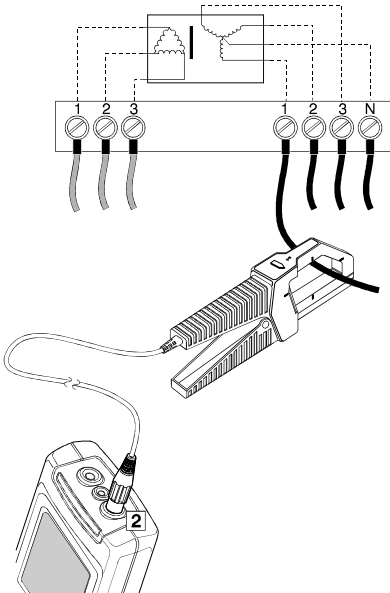

- ① Observe the K-factor (KF).
- 5 Measure the K-factor on phase 2 and phase 3 too, and take the highest KF-reading.

(continue on next page)

If the measured K-factor is higher than the K-factor specified on the transformer, you either must replace the transformer by a transformer with a higher K-rating, or reduce the maximum load on the transformer.

When choosing a replacement transformer, use the next trade-size higher than the highest measured K-factor. For example, a measurement of 10.3 KF on an installed transformer means replacing it with a K-13 unit.

# Chapter 3

## Lighting Loads

### Introduction

This chapter provides applications of problems and phenomena that are likely to occur in a lighting system.

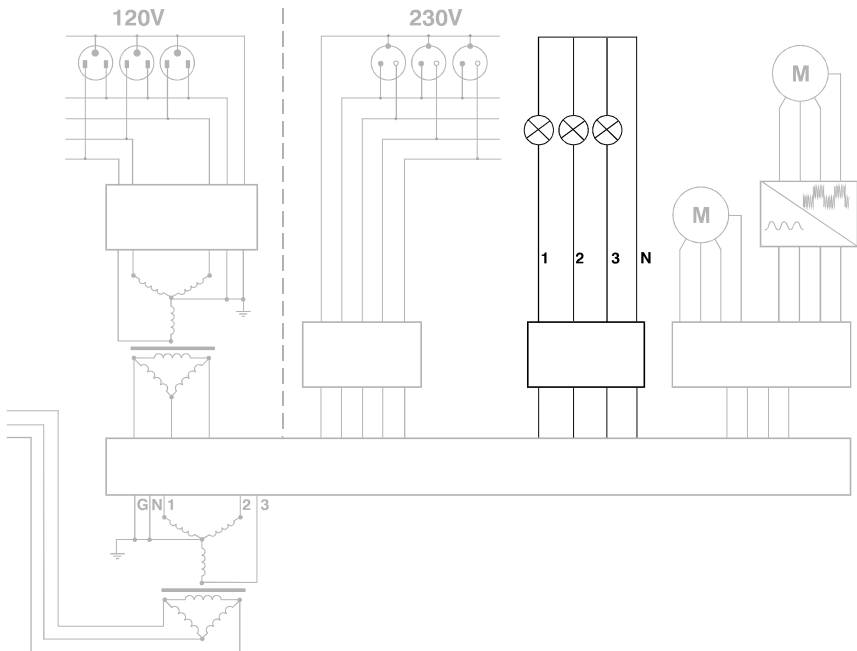





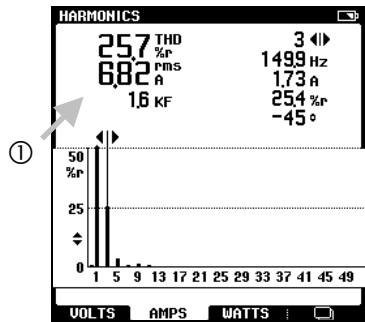
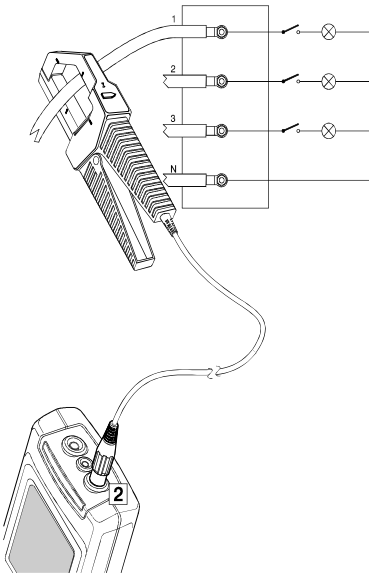

Figure 3. Distribution System: Lighting Loads

## Measuring Current Harmonics

Check whether the lighting system causes excessive harmonics. These may influence the system.

- 1  Open the main menu.
- 2    
- 3  Select **AMPS**.
- 4 Make connections as shown below. Turn all lights on.







- ① Look at the harmonics spectrum and read the THD value. If the current THD is less than 20%, the harmonic distortion is probably acceptable.

Consider replacing lights with a better quality (which produces less harmonics) or install a harmonic filter to avoid the injection of harmonics into the system.

## Measuring Power on Single Phase Loads

Inductive loads, such as fluorescent lamps, cause a phase shift between the voltage and the current. This influences the real power consumption.

- 1  Open the main menu.
- 2   → 
- 3 Make connections as shown below:

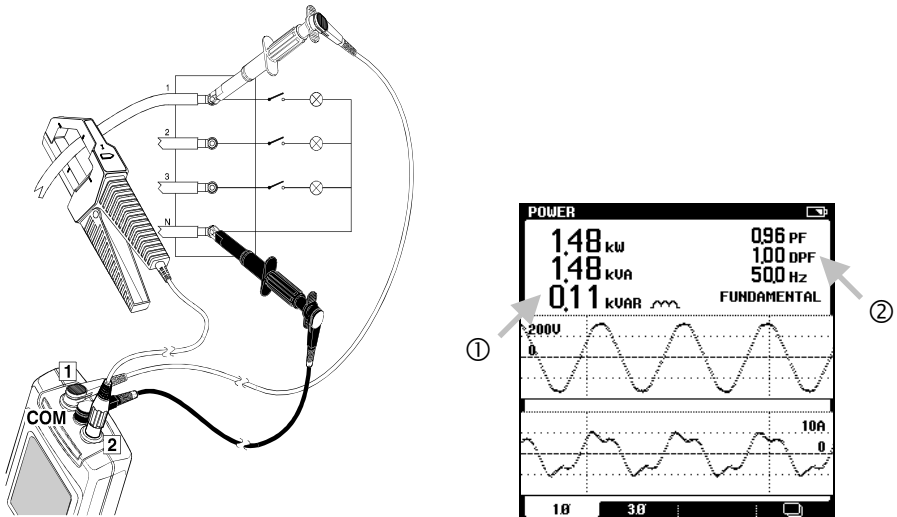

- ① Look at the W reading. It shows the real power consumption of the lights.
- ② Look at DPF ( $\cos \phi$ ) reading. Low DPF means that corrective measures have to be taken such as installing capacitors to correct the phase shift between the voltage and the current.

### Note

*If PF and DPF differ greatly, this indicates the presence of harmonics. Check for harmonics first, before installing capacitors.*



# Measuring Surge Current

Check for a high inrush currents that may cause voltage sags in a 'weak' lighting system. A system is considered 'weak' when it has a high impedance.

1  Open the main menu.



2   → 



Set the expected maximum current during the inrush:

3   → 

4   → 

Set the expected inrush time:

5   → 

6   → 



**7** Make connections as shown below:

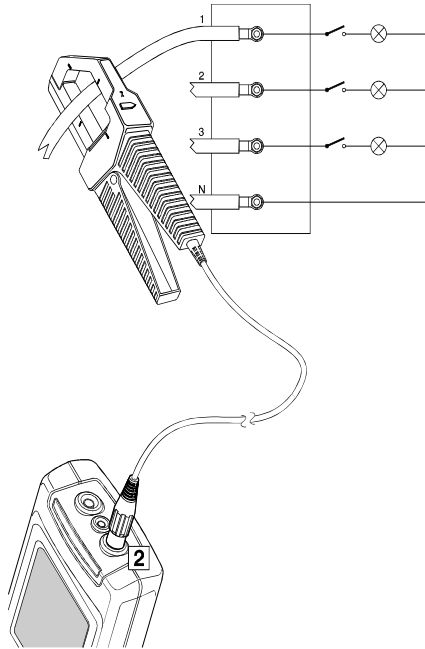

**8**



◀ **START**



**9**

Turn on the lights.



If nothing happens:



Press **HOLD** to stop.

Repeat the measurement at a lower value for **MAXIMUM CURRENT** in step 3 and 4.



- 10  Move the left cursor to the beginning of the inrush.
- 11  Select the right cursor.
- 12  Move the right cursor to the end of the inrush.

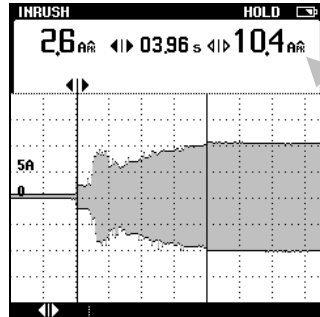

- ① Read the peak current. It indicates the maximum current during the moment the lights were turned on.

### Tip

Perform a sags and swells measurement (see chapter 2: “*Monitoring rapid Voltage Fluctuations*”) while turning on the lights to examine whether voltage sags will occur in other parts of the distribution system.



# Chapter 4

## Motor Loads

### Introduction

This section provides examples that you can use to troubleshoot induction motors with and without an adjustable speed drive.

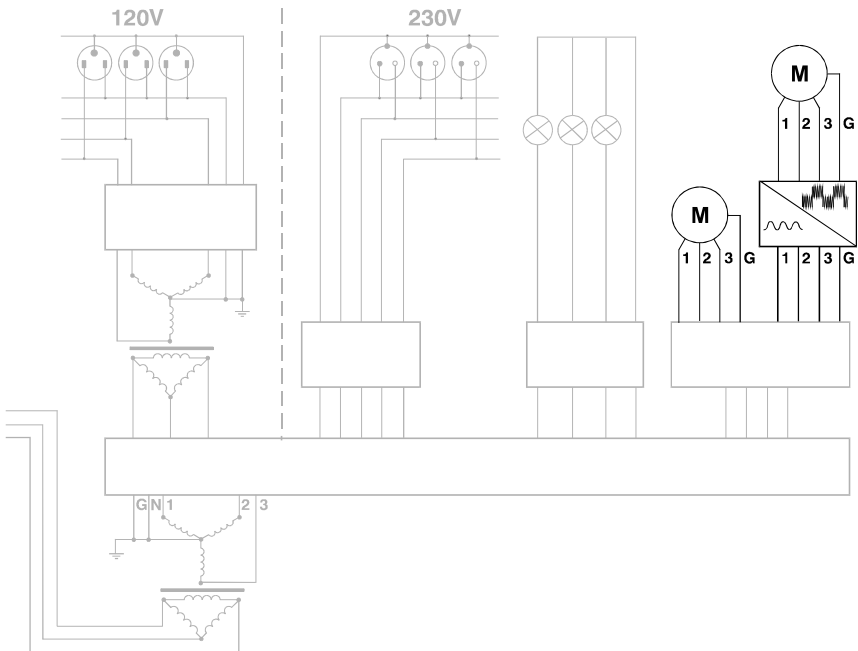





Figure 4. Distribution System: Motor Loads

## Induction Motors

### Checking Voltage Imbalance

For 3 phase induction motors, the supply voltage on all three phases should be in balance. Voltage imbalance causes high unbalanced currents in the stator windings, resulting in overheating and reduced motor life.

- 1  Open the main menu.
- 2   → 
- 3 Make connections as shown below:

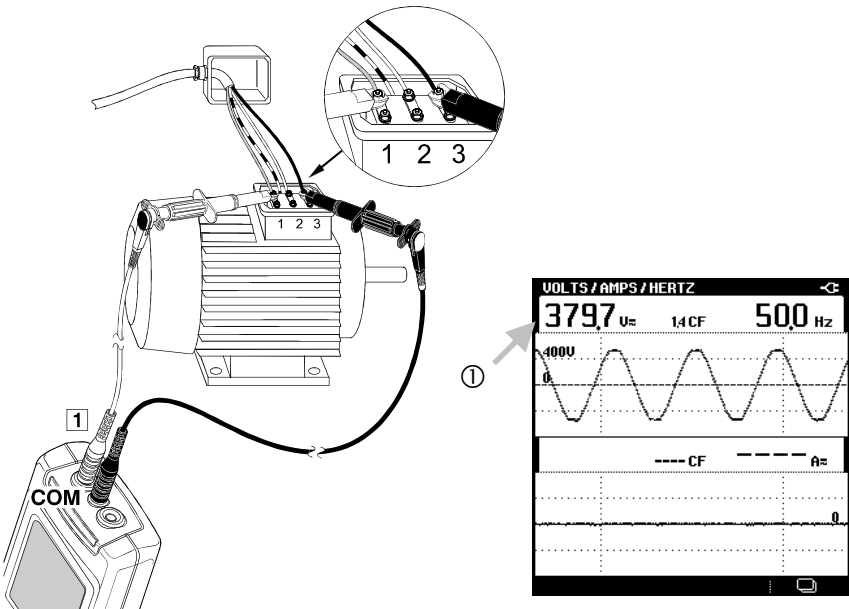

- ① Write down the voltage reading of phase 1 to phase 3 ( $V_{1-3}$ ).
- 4 Repeat this measurement for phase 2 to phase 3, and for phase 1 to phase 2. Write down the values for  $V_{2-3}$  and  $V_{1-2}$ .

**5** Calculate the voltage imbalance (fill in your measurement results):

**a** First calculate the average voltage:

**Average Voltage:**

$$\frac{\text{___ } V_{1-3} + \text{___ } V_{2-3} + \text{___ } V_{1-2}}{3} = \frac{\text{___ } V}{3} = \text{___ } V_{\text{AVERAGE}}$$

**b** Second, calculate the maximum deviation from the mean. Ignore the minus signs:

**Maximum Deviation:**

$$V_{1-3} - V_{\text{AVERAGE}} = \text{___ } V$$

$$V_{2-3} - V_{\text{AVERAGE}} = \text{___ } V \quad \text{Largest deviation: ___ } V_{\text{DEVIATION}}$$

$$V_{1-2} - V_{\text{AVERAGE}} = \text{___ } V$$

**c** Finally, calculate the voltage imbalance:

**Voltage Imbalance:**

$$\frac{\text{___ } V_{\text{DEVIATION}}}{\text{___ } V_{\text{AVERAGE}}} \times 100\% = \text{___ } \%$$

Voltage imbalance for three-phase motors should not exceed **1%**. Voltage imbalance may be caused by bad connections, contacts or fuses; or is caused by problems at the source transformer.

**Example**

**a**

$$\frac{403 V_{1-3} + 391 V_{2-3} + 406 V_{1-2}}{3} = \frac{1200 V}{3} = 400 V_{\text{AVERAGE}}$$

---

**b**

$$403 V_{1-3} - 400 V_{\text{AVERAGE}} = 3 V$$

$$391 V_{2-3} - 400 V_{\text{AVERAGE}} = -9 V \quad \text{Largest deviation: } 9 V_{\text{DEVIATION}}$$

$$406 V_{1-2} - 400 V_{\text{AVERAGE}} = 6 V$$





---

**c**

$$\frac{9 V_{\text{DEVIATION}}}{400 V_{\text{AVERAGE}}} \times 100\% = 2.25 \%$$

## Checking Current and Current Imbalance

After checking voltage imbalance, check for current and current imbalance. Unbalanced currents cause overheating and reduce motor life. Also single phasing (complete loss of power on one of the phases feeding the motor) may cause overheating in the two other phase windings.

- 1  Open the main menu.
- 2   → 
- 3 Make connections as shown below. Run the motor at full load.

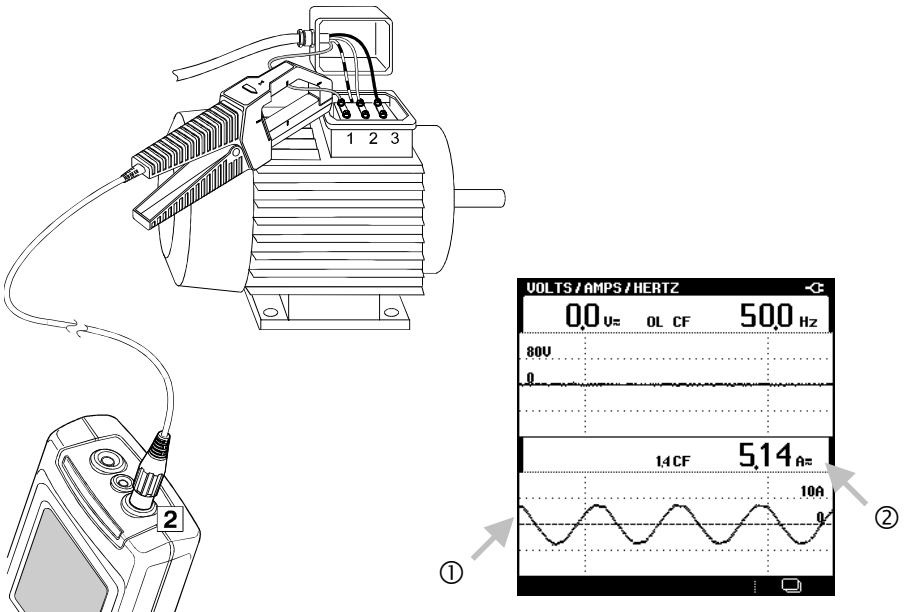

- ① If no current is present, you may assume an open fuse or winding.
  - ② Write down the current reading ( $A_1$ ).
- 4 Repeat this measurement for phase 2 and phase 3. Write down the values for  $A_2$  and  $A_3$ .

- 5** Calculate the current imbalance. Use the same formula as in the previous section but substitute current for voltage.

Current imbalance for three-phase motors should not exceed **10%**.

**Example**

<b>a</b>	$\frac{33 A_1 + 29 A_2 + 34 A_3 = 96 A_{\text{TOTAL}}}{3} = 32 A_{\text{AVERAGE}}$				
<b>b</b>	<table style="width: 100%; border: none;"> <tr> <td style="width: 60%;"><math>33 A_1 - 32 A_{\text{AVERAGE}} = 1 \text{ A}</math></td> <td rowspan="3" style="vertical-align: middle; padding-left: 20px;">Largest value: <math>3 A_{\text{DEVIATION}}</math></td> </tr> <tr> <td><math>29 A_2 - 32 A_{\text{AVERAGE}} = -3 \text{ A}</math></td> </tr> <tr> <td><math>34 A_3 - 32 A_{\text{AVERAGE}} = 2 \text{ A}</math></td> </tr> </table>	$33 A_1 - 32 A_{\text{AVERAGE}} = 1 \text{ A}$	Largest value: $3 A_{\text{DEVIATION}}$	$29 A_2 - 32 A_{\text{AVERAGE}} = -3 \text{ A}$	$34 A_3 - 32 A_{\text{AVERAGE}} = 2 \text{ A}$
$33 A_1 - 32 A_{\text{AVERAGE}} = 1 \text{ A}$	Largest value: $3 A_{\text{DEVIATION}}$				
$29 A_2 - 32 A_{\text{AVERAGE}} = -3 \text{ A}$					
$34 A_3 - 32 A_{\text{AVERAGE}} = 2 \text{ A}$					
<b>c</b>	$\frac{3 A_{\text{DEVIATION}}}{32 A_{\text{AVERAGE}}} \times 100\% = 9.4 \%$				





*Note*

*To detect single phasing, always check the current on all three phases. When a voltage measurement is made at the motor terminals, the voltages will read close to normal as motor action is inducing voltage into the open winding.*

## **MEASURING POWER IN 3-PHASE BALANCED SYSTEMS.**

The Fluke 43B can perform power measurements on 3-phase, 3-conductor balanced power systems. The load must have approximately the same voltage and current on all three phases, and must be wired in a wye or delta configuration.

The balanced load makes it possible to calculate 3-phase power from one current and one voltage channel. Three phase power measurements are possible for the fundamental only.

- 1  Open the main menu
- 2   
- 3  Select 3-phase measurement
- 4 Make the connections as shown in the help screen

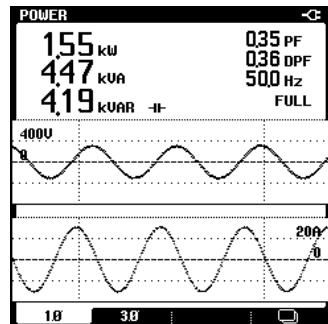

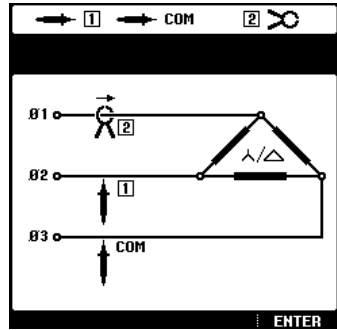
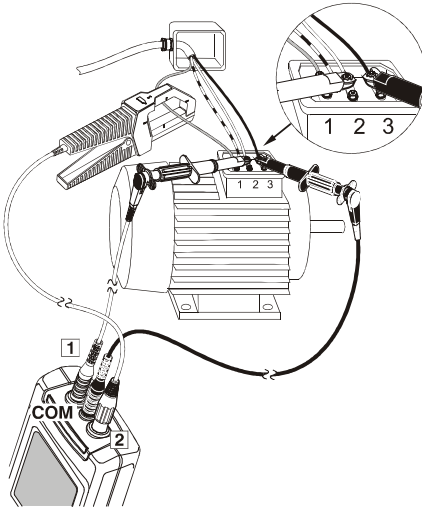

- 5**  Press **ENTER** to return to the main menu

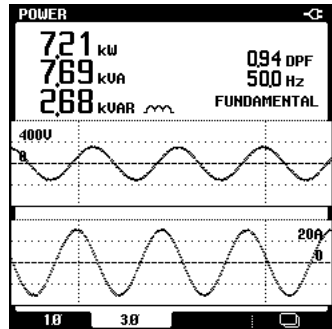

The voltage and current waveforms are displayed with a phase shift of 90°. This is due to the fact that voltage and current are measured in different phases. This phase shift is automatically corrected for the readings.



## **Measuring Peak and Inrush Current**

High inrush currents of motors can cause breakers to trip or fuses to open.

**1**  Open the main menu.

**2**   → 

Set the maximum expected current during the inrush. This might be 6 to 14 times the full load current of the motor.

**3**   → 

**4**   → 

Set the expected inrush time:

**5**   → 

**6**   → 





7 Make connections as shown below:

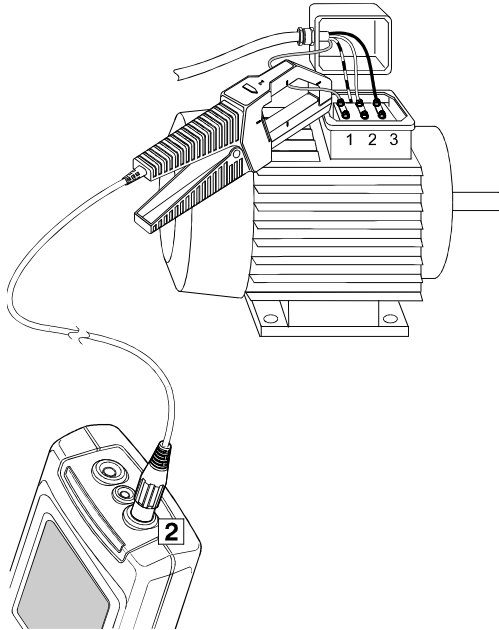

8



START



9

Turn the motor on.



If nothing happens:



Press **HOLD** to stop.

Repeat the measurement at a lower value for **MAXIMUM CURRENT** in steps 3 and 4.



- 10**  Move the left cursor to the beginning of the inrush.
- 11**  Select the right cursor.
- 12**  Move the right cursor to the end of the inrush.

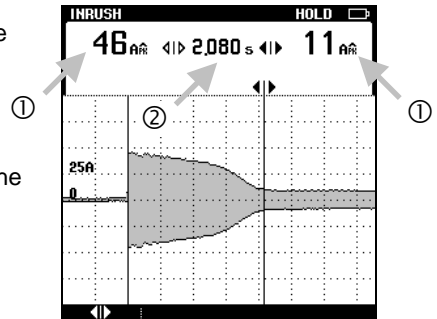





- ① Read the peak currents at the cursors. Can fuses and breakers withstand these currents? Are conductors properly sized?
- ② Read the time between the cursors. Can fuses and breakers withstand the inrush current during this period? Fast acting breakers and fuses may trip.
- 13** Repeat this measurement for phase 2 and phase 3.

## Measuring Power Factor of 3-Phase Motors

A power factor with a value close to 1 means that nearly all supplied power is consumed by the motor. A power factor of less than 1 results in extra currents, called *reactive currents*. This requires larger power lines and transformers. Also there will be more power loss in the transmission lines.

### Grounded Y-Connection with Balanced Load

For balanced motors with a grounded Y-connection, you can read the Power Factor directly from the screen. To test for a grounded Y, simply check the three phase-to-ground voltages. If the voltages are stable and equal, then the system is wired as a grounded Y. Measure Power Factor as follows:



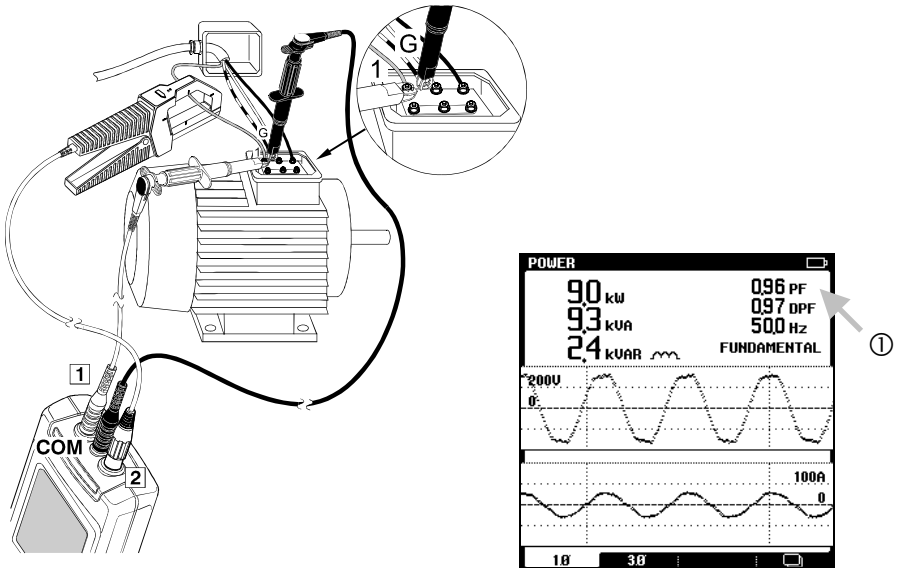

- 1  Open the main menu.
- 2   → 
- 3 Make connections as shown below. Run the motor under normal full load (power factor decreases at less than full load).



- ① Observe the Power Factor.

## Delta connection or floating systems

For delta systems, the procedure is more complex. Use the following procedure to calculate the Power Factor for a 3-phase grounded delta connected motor or for floating sources.

- 1  Open the main menu.
- 2   → 
- 3 Make connections to phase 1 and 3 as shown below. Run the motor under normal full load (power factor decreases at less than full load).

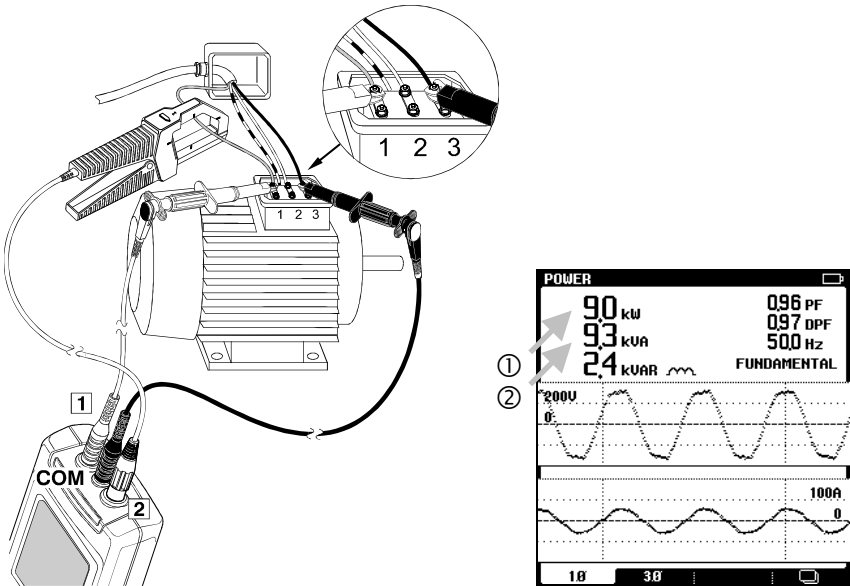

- 4** Move the red test lead and the current probe to phase 2 (keep the black test lead attached to phase 3).

Write down the value for true power reading ( $kW_2$ ). If the power factor is smaller than 1,  $kW_1$  and  $kW_2$  will be different even if the load currents are equally balanced. Note that the apparent power (kVA) is equal to the first measurement.

- 5** Calculate the power factor (fill in your measurement results):

$$\frac{\text{___ } kW_1 + \text{___ } kW_2}{\sqrt{3} * \text{___ } kVA} = \frac{\text{___ } kW_{TOTAL}}{\text{___ } kVA} = \text{___}$$

**Example**

**Measured:  $kW_1 = 170 kW$     $kW_2 = 68 kW$     $kVA = 188 kVA$**





$$\frac{170 kW + 68 kW}{1.73 * 188 kVA} = \frac{238 kW_{TOTAL}}{325,6 kVA} = 0.73$$

Poor power factor can be improved by adding capacitors in parallel with the load.

If harmonics are present, consult with a qualified engineer before installing capacitors. Non-linear loads such as adjustable frequency motor drives cause non-sinusoidal load currents with harmonics. Harmonic currents increase the kVA and thereby decrease total power factor. Poor total power factor caused by harmonics requires filtering for correction.

## Measuring Voltage Harmonics

When the supply voltage is distorted by harmonics, the motor can suffer from overheating.

- 1  Open the main menu.
- 2   → 
- 3 Make connections as shown below:

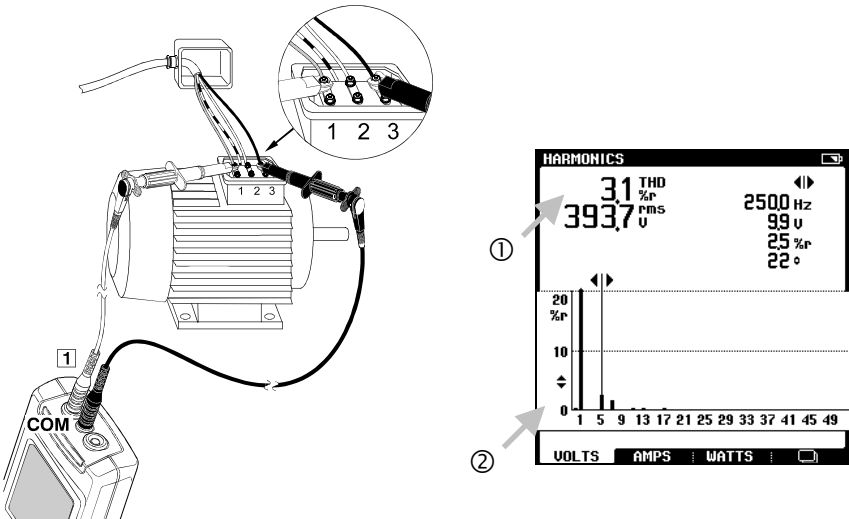





- ① Look at the THD reading. In general, the Total Harmonic Distortion of the voltage supplied to an induction motor should not exceed 5%.
- ② Look at the harmonic spectrum.  
 Negative sequence harmonics (5th, 11th, 17th, etc.) will cause most heating because they try to run the motor slower than fundamental (they create reverse rotating magnetic fields within the motor). Positive sequence harmonics (7th, 13th, 19th, etc.) also cause heating because they try to run the motor faster than fundamental.

## Adjustable Speed Drives

### Checking Current on Phases

When a motor drive is tripping, first check for voltage imbalance (see “Checking Voltage Imbalance”). Then check the current on all three phases feeding the motor.

- 1  Open the main menu.
- 2   → 
- 3 Make connections as shown below. Run the motor at full load.

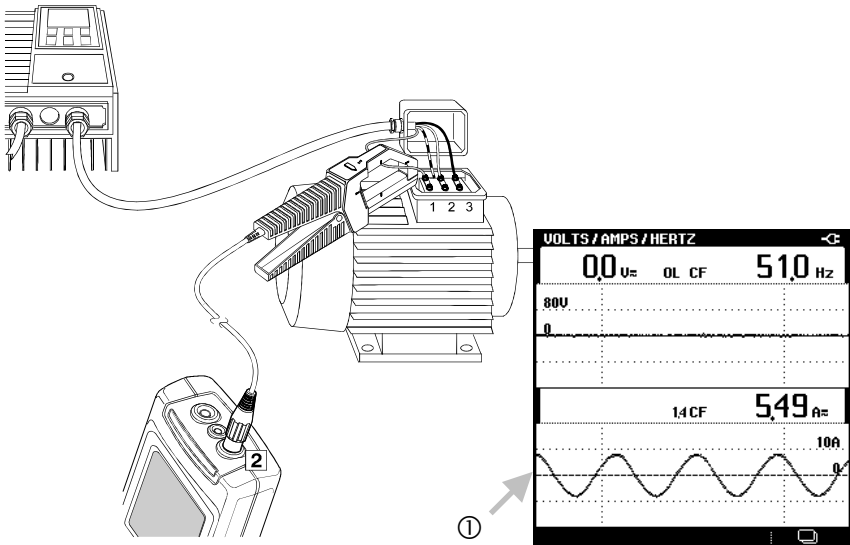





- ① If no current is present, you may assume an open fuse or an open circuit in wiring. The drive will trip.

- 4 Repeat the measurement for phase 2 and phase 3.

## Measuring Fundamental of Motor Voltage

Check the condition of a drive.

- 1  Open the main menu.
- 2    →
- 3  Move the cursor over the fundamental (1<sup>st</sup>).
- 4 Make connections as shown below. Run the motor at full speed and full load.

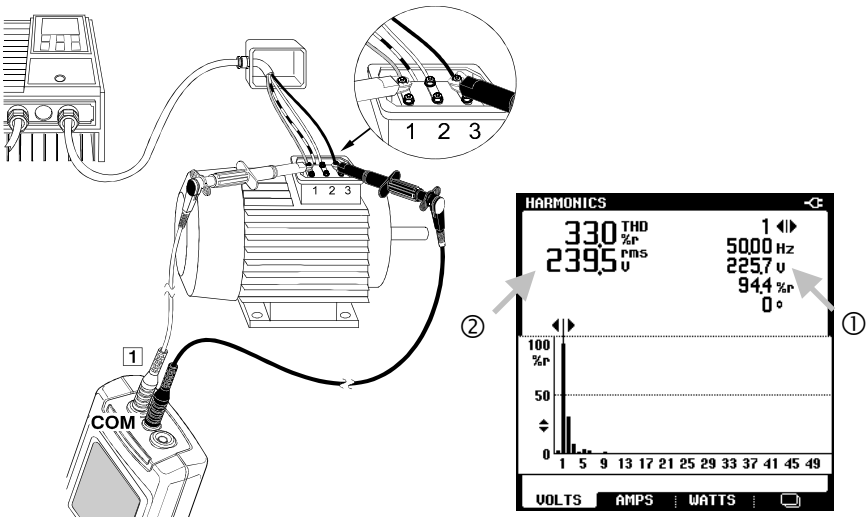





- ① Read the voltage of the fundamental. The voltage should be slightly less than the line voltage. If the voltage is significantly lower than the line voltage, it indicates an improper drive. To be sure, compare with a known good drive.
- ② Read the total rms voltage. If the value on the drive display is lower, the display probably shows the average voltage or fundamental instead of the rms voltage.



## Measuring Frequency of Motor Current

The frequency of the motor current correlates with motor speed.

- 1  Open the main menu.
- 2   → 
- 3 Make connections as shown below:

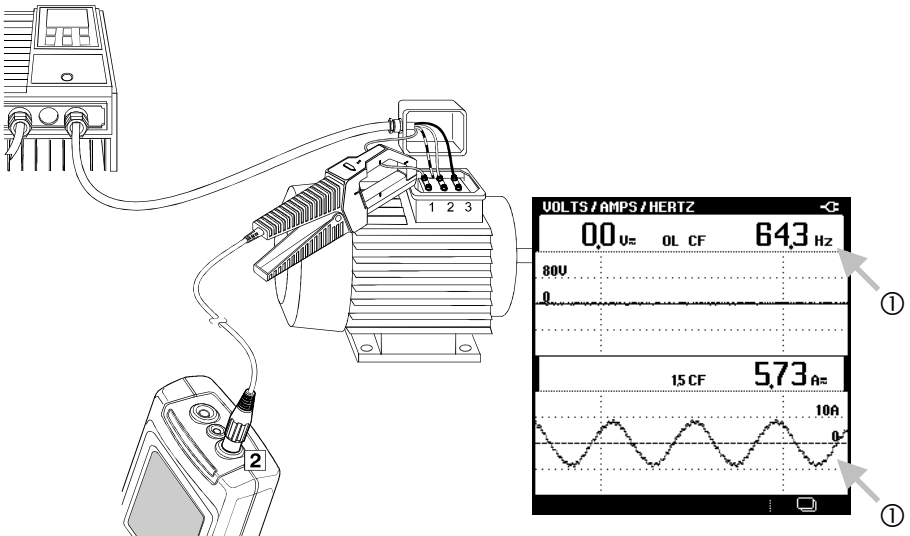

- ① Vary the speed of the motor and look at the frequency and the waveshape of the current. The frequency of the current should correlate with the speed of the motor.
- 4 Repeat this measurement for phase 2 and phase 3.

### Note

*Because there is no voltage signal present, the frequency is calculated from the current signal on input 2.*



# **Chapter 5**

## **Scope Mode**

### ***Introduction***





The Fluke 43B incorporates a full-featured digital storage oscilloscope with 20 MHz bandwidth. Channel 1 is available to display voltage waveforms while channel 2 can be used to display current waveforms via the clamp-on AC current probe. This chapter gives a step-by-step explanation of the most important scope functions.

#### *Note*

*It is a good idea to reset the Fluke 43B before you start this new application. This way, you always start from the same setup.*

## Basic One Channel Measurement.

Proceed as follows:

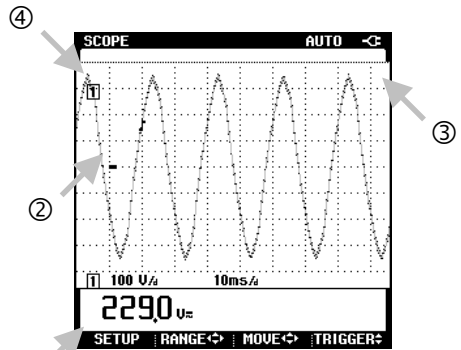
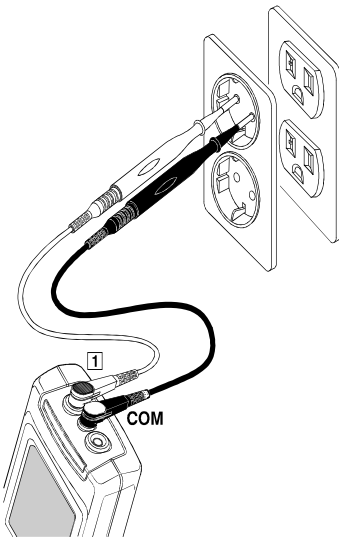

- 1  Press **MENU** twice to open the main menu.
- 2   → 
- 3 Make the connections as shown below:





- ① The rms voltage readout should be close to the nominal line voltage, for example 120V or 230V.
- ② The waveform should be smooth, sinusoidal and in the vertical middle of the screen.
- ③ Fluke 43B is in the Auto mode. This function optimizes the position, range, time base, and triggering and assures a stable display on nearly all waveforms.
- ④ The trace identifier [1] is visible on left of the waveform area. The ground marker icon (-) identifies the ground level of the waveform.

## Set Up Selection

The active readout shows the AC+DCrms value of the input signal. This is because Fluke 43B just has been reset. The scope mode offers more readouts. As an example, selection of the frequency readout (Hz) is given. Also the meaning of the other readouts are explained.

- 1  Select **SETUP**
- 2  You are in the **SCOPE SETUP** screen for **INPUT [1]**



- 3  **Hz**
- 4  The **INPUT [1]** reading is changed to **Hz**
- 5  Select **BACK**; the readout is in **Hz**

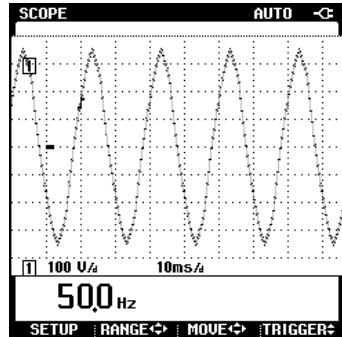



- ① The frequency readout should be close to 50 or 60 Hz.
- ② Other readouts can be selected: their functions are indicated in the table below.

SELECTED	MEASURING RESULT
DC	Readout of the DC part of the input signal
ACrms	Readout of the ACrms part of the input signal
AC+DCrms	Readout of true rms-value of the complete input signal.
Hz	Readout of the frequency.
Pulse+	Readout of the duration of the positive-going part of the input signal (usually a square wave).
Pulse-	Readout of the duration of the negative-going part of the input signal (usually a square wave).
Duty+	Readout of the duration of the positive-going part of the input signal (usually a square wave) as a percentage of the period time.
Duty-	Readout of the duration of the negative-going part of the input signal (usually a square wave) as a percentage of the period time.
Peak max	Readout of the maximum peak value of the input signal.
Peak min	Readout of the minimum peak value of the input signal.
Peak m/m	Readout of peak-to-peak value of input signal.
Crest	Readout of the peak value divided by the rms value.
Phase, Input [2] only	Readout of the phase difference between the waveforms at input [1] and input [2]

## Viewing Signal Details

The amplitude and the number of periods of the waveform on the screen are automatically adjusted. This gives a clear overview of the general waveform characteristics. In case certain signal details are of interest, you can manually change amplitude and number of periods. The Auto mode is then switched off: the indication AUTO in the header of the SCOPE screen changes to 1/2 AUTO.

**1**  Select **RANGE**

**2**  Press the left button to increase the number of periods

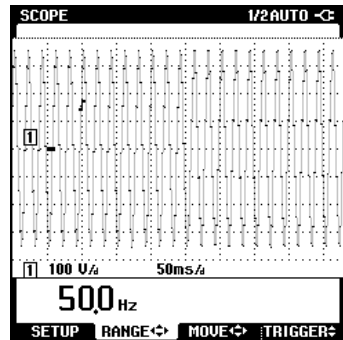

**3**  Press the right button to decrease the number of periods

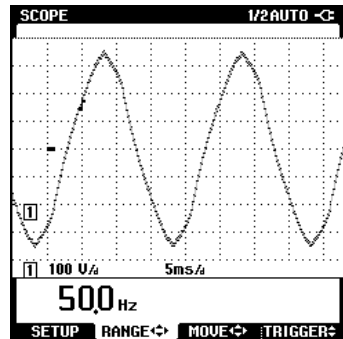

The scope screen is divided into a grid of 8 vertical and 9.5 horizontal divisions. The magnitude of a horizontal and a vertical division is indicated on the screen directly under the grid.

In the screen above, one horizontal grid division equals a time span of 5 milliseconds which is indicated as 5 ms/d.

- 4**  Press the lower button to reduce the waveform amplitude

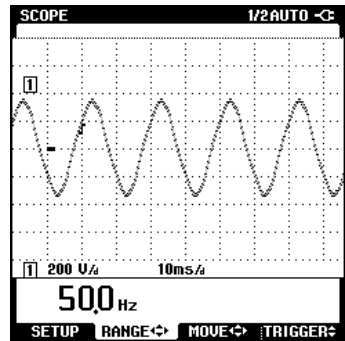

- 5**  Press the upper button to enlarge the waveform amplitude

In this example the waveform amplitude is higher than the screen. Rescale the amplitude within the screen area to view the whole waveform.

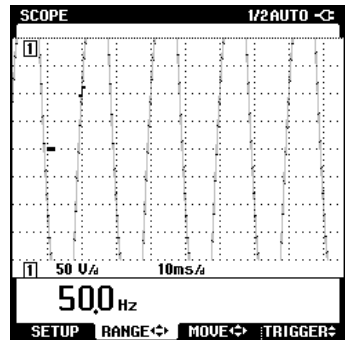





In the screen above, one vertical grid division equals a voltage of 50 volt which is indicated as 50 V/d.





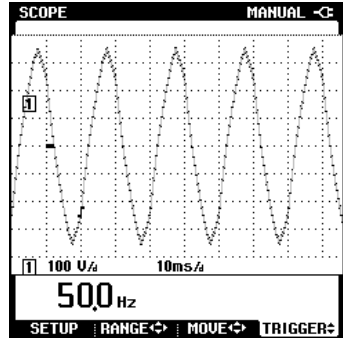

## Triggering

On the waveform you can see the trigger icon  $\lceil$ . This symbol represents the level at which the waveform is triggered. Fluke 43B automatically selects the most optimal level. If required, you can shift the trigger level to any desired value.

- 1  Press **TRIGGER**
- 2   
 Press the upper button to increase the trigger level
- 3   
 Press the lower button to decrease the trigger level



Note that the Fluke 43B is capable of capturing signal details occurring prior to the trigger point. This is a feature that is not offered in analog scopes. The default is to display 2 divisions prior to the trigger point. This can be adjusted between 0 and 10 divisions.

- 1  Press **MOVE**
- 2   
 Press the right button to increase the number of divisions before the trigger point
- 3   
 Press the left button to decrease the number of divisions

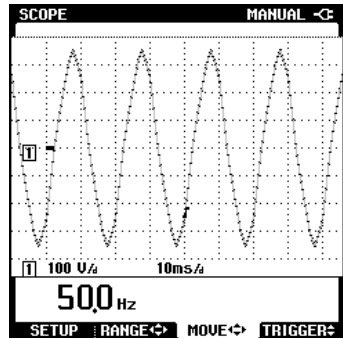



The indication 1/2 AUTO in the header of the SCOPE screen changes to MANUAL if waveform amplitude, number of periods, and triggering are all under manual control.

## ***Return to Auto mode***

AUTO mode automatically optimizes position, range, time base, and triggering to a stable and well-defined display of nearly every type of waveform. Here is how to return the Fluke 43B to AUTO mode.

To select AUTO proceed as follows:

- 1**  Press **SETUP**
- 2**  Press **AUTO** to return to auto mode

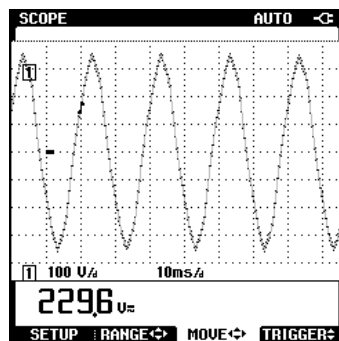



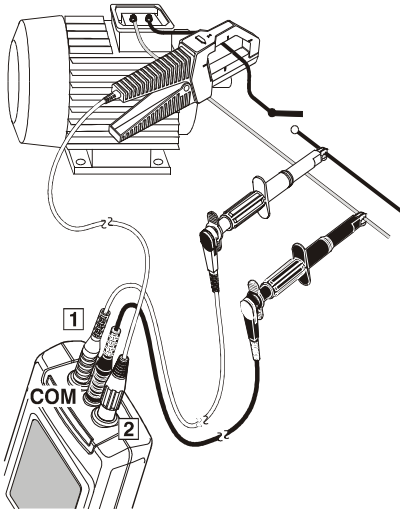

## Dual Channel Measurement

Dual channels allow for simultaneous display of cause and effect. For example, turning on a motor will momentarily draw a high current and cause a voltage sag. The current will be high immediately after turn-on and should stabilize to some nominal value. Especially if the supply is weak, a voltage sag will be observed. The dual channel mode can be used to observe current and voltage simultaneously. The scope mode gives many possibilities to zoom in on signal details so that every phase of the start up of the motor can be monitored.

- 1 Make connections as shown below



- 2 Reset Fluke 43B
- 3  Press **MENU** twice to open the main menu.
- 4   → 

Fluke 43B is in single channel mode now. Voltage is displayed on channel [1]. In the next steps dual channel mode is selected so that current is displayed simultaneously on channel [2]. Proceed as follows.

5  Press **SETUP**

6   
 **INPUT [2]**

 **COUPLING: OFF** → 

7   
 **INPUT [2] COUPLING**

**DC**  → 

8  Press **BACK**. Two inputs are displayed simultaneously now

The ground marker icons (-) of both waveforms are in the vertical mid of the screen so that the waveforms cover each other.

The trace identifiers [1] and [2] indicate the relation between waveform and input signals. In the next steps it is explained how to adapt amplitude and vertical position of both waveforms so that they do not cover each other.

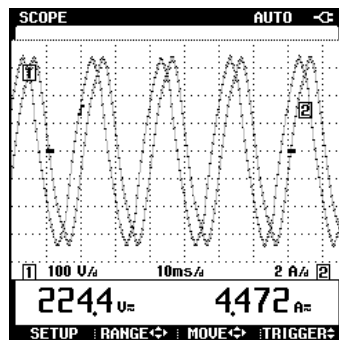









Use **RANGE** to adjust waveform amplitudes to 2 .. 4 divisions each. Use **MOVE** to position one waveform in the upper half of the screen and the other waveform in the lower half.









Fluke 43B now displays voltage and current and the display is continuously refreshed: it always represents the present situation. This is the **NORMAL** mode of the time base. You can press **HOLD / RUN** to freeze the display. **SINGLE** mode can be used to capture events that occur only once.

## Single Mode

In single mode it is possible to freeze the current and voltage immediately after turn-on. To capture this event, the SINGLE timebase mode is used. In SINGLE mode a waveform is captured once, based upon a certain trigger event on one of the input signals. To capture a turn-on event the current on input [2] makes a good trigger. At power-on the current increases, causing a well-defined trigger condition.

- 1  Press **SETUP**
- 2   → 
- 3  →   **BACK**

Input [2] is selected for triggering: the trigger icon  is on waveform [2] now. Time base is still in NORMAL mode and the display is updated continuously. SINGLE mode is selected in the next steps.

- 4   → 
- 5   →   **BACK**
- 6  Press **HOLD/RUN** and the waveforms at input [1] and [2] are recorded once
- 7 Switch off the motor
- 8  Press **HOLD/RUN**: Fluke 43B is ready to capture the inrush current and voltage at motor turn-on.
- 9 Switch the motor on. Fluke 43B now captures voltage and current.

The Fluke 43B has captured voltage and current during motor turn-on. The instant of turn-on is represented by the horizontal position of the trigger icon  $\lrcorner$ . Voltage and current are visible for 2 horizontal divisions before turn-on. During that period the current is zero and voltage is unloaded and at maximum. After turn-on current increases rapidly and voltage drops due to the load of the motor. After the motor has started up, current stabilizes to a lower steady state value and as a result the voltage rises.

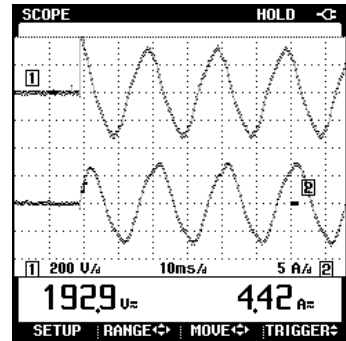

- ① If Fluke 43B does not capture waveforms upon switch-on of the motor, try changing the trigger level. Bear in mind that the trigger level always must be positioned within the amplitude range of the waveform.
- ② By changing time per division and making a new measurement, you can zoom in on details of the switch-on process. Press **HOLD/RUN** to arm the scope for the next measurement.

# Chapter 6

## Handling Screens and Data

### Introduction

This section describes saving, viewing and printing of screens. It also describes how screens can be used in Word® documents to create reports.

How to record Harmonics over time by using FlukeView software is also explained.

Screens are saved in a format that allows for post processing. This makes it possible to use a cursor on a recording that has been saved. With the cursor positioned on an event of interest, you can read the measurements from the corresponding point in time.

First, perform a measurement, for example measuring line voltage. Use this screen to experiment.

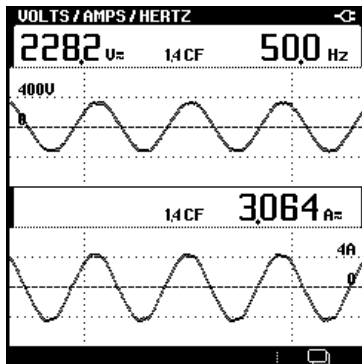



Figure 5. VOLTS/AMPS/HERTZ screen

## **Saving Screens**







Any measurement screen that is on the display, can be saved by simply pressing the **SAVE** key.

- 1  Save the screen.

A message is displayed that the screen has been saved. Repeat this action several times to fill more memories with screens.





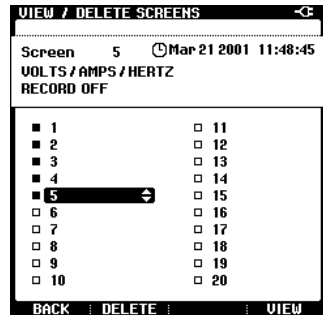

If you try to save a screen while all memories are filled, you will see a message telling that you first must delete one or more memories.

## **Viewing and Deleting screens**

- 1  Open the main menu.
- 2    →
- 3   Select a screen.
- 4  Press **VIEW**.



You can now browse through the saved screens:

- 5     
- 6  Press **BACK** to return to the overview screen.

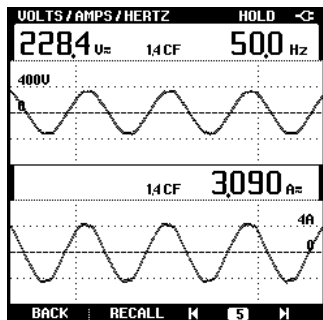



From the overview screen you can delete screens:

- 7  Press **DELETE**.

A message appears asking you whether you want to delete this screen. After you confirm, the screen will be deleted.



**8**  Select a screen that has been saved in memory. Press **VIEW**.

**9**  Press **RECALL** to restore the data on screen as it was at the time that it was saved.

## **Printing Screens**

You can print both actual screens and saved screens.

- 1 Connect the Fluke 43B to a printer as shown in the picture below.

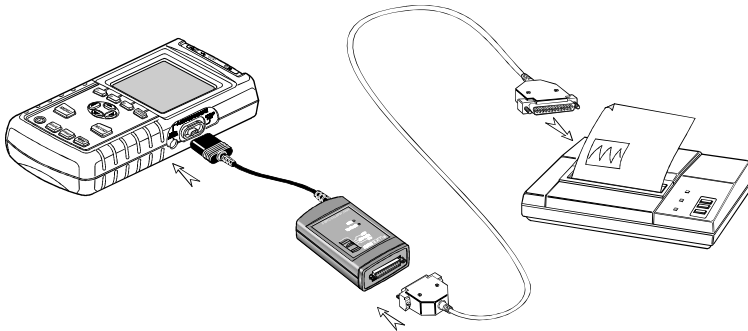

- 2  Print the actual screen.  
To print a saved screen, view it first (see previous section “*Viewing and Deleting Screens*”).

If the printer does not print, refer to the Users Manual manual for troubleshooting tips.



### *Note*

*You can also print screens using FlukeView. Refer to your FlukeView Users Manual for instructions.*

## Creating Reports

You can use actual screens or saved screens in Word documents, to create reports.

First install the FlukeView software for the Power Quality Analyzer by running the **SETUP** procedure from the CD-ROM. Instructions on getting started are given on the CD-ROM package. The FlukeView **SETUP** procedure installs a predefined report with the name **QREPORT.DOC**.

- 1 Connect the Fluke 43B to the PC (see FlukeView Users Manual).
- 2  FlukeView Qreport      Open the document **QREPORT.DOC**.
- 3 Fill out the form by clicking on the grey fields and typing your text.
- 4       Click this button to insert the actual screen from the Fluke 43B into your report.
- 5 Type a description in the **Description** field.

**Fluke 43 Power Quality Analyzer Test Report**

**Company:** Fluke Industrial  
**Contact:** A. Person  
**Address:** Street 43  
**Zip:** 1234 AB  
**City:** Almelo  
**Phone:** 12 345 678910  
**Fax:** 12 345 678911  
**E-mail:** aperson@almelo.fluke.nl  
**Date:** May 6, 1998

---

**Instrument Screen:**

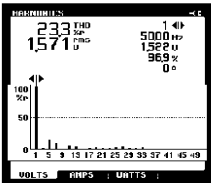

The screenshot shows the following data:

233	THD	1.4%
1571	RMS	5000
	UF	152
		96.9%
		0°

The graph shows a waveform with a peak of 100% and a duration of 49 units.

**Description:**  
 On these lines you can type your description.



- 6       Click this button to print your report.

## **Recording Harmonics over Time**

You can use the recording capabilities of FlukeView software to record harmonics over time. This allows you to analyze the behavior of your installation over an extended period of time. For example recording current harmonics over 24 hours will give insight in load variations on your system.

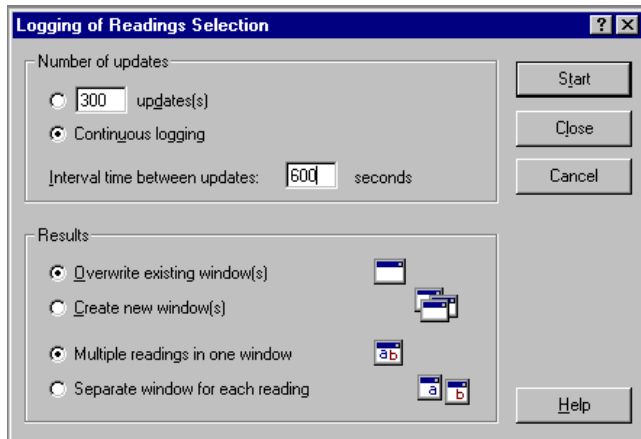
- 1                    Setup the Fluke 43B for measuring current harmonics.
  
- 2                    Connect the Fluke 43B to the PC (See FlukeView Users Manual).
  
- 3                    Run FlukeView.
  
- 4                     Click this button to open the Logging of Readings Selection.
  
- 5                    In the selection menu you can enter the number of updates and interval time between each update.



- 6** Click Start to start recording the harmonics. FlukeView will display the actual reading and in the background all the readings are logged in memory.
- 7**  Click this button to stop recording.
- 8**  Click this button to save the recorded values in an ASCII file format (.CSV or .TXT).
- 9** You can now open the saved file using a spreadsheet program to analyze the saved data.



# Chapter 7

## Definitions

### Active Power

The Active Power (Watt) is that portion of electrical power that is real. It includes heat losses. Utility charges are based on Watts.

### Apparent Power

Apparent Power (VA) is the product of the rms voltage and current which relates to the effective load seen by the transformer and current carrying conductors.

### Black out (see outage)

### Brown out (see sag)

### Cos $\phi$ (see Displacement Power Factor, DPF)

### Displacement Power Factor, DPF (Cos $\phi$ )

The ratio of real power to apparent power. Displacement Power Factor is the cosine of the phase angle between the fundamental current and the fundamental voltage (cos  $\phi$ ). Inductive loads cause current to lag behind voltage, while capacitive loads cause current to lead voltage.

The displacement power factor uses only the fundamental of the signal for its calculation. (see also: *Power Factor*)

DPF	Interpretation
0 to 1	current leads or lags, device is consuming power.
1	current and voltage in phase, device is consuming power.
-1	current and voltage in phase, device is generating power.
-1 to 0	current leads or lags, device generating power.

### Dropout

A discrete voltage loss. A voltage sag\* for a very short period of time (milliseconds).

**Harmonic (component)**

A sinusoidal component of an ac voltage that is a multiple of the fundamental frequency.

**Harmonic Distortion**

Periodic distortion of the sine wave. The waveform becomes distorted when higher frequency components are added to the pure sine wave.

(see also: *Total Harmonic Distortion*)

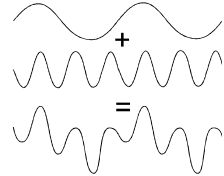

**Harmonic Order**

A number indicating the harmonic frequency: the first harmonic is the fundamental frequency (50 Hz or 60 Hz), the third harmonic is the component with three times the fundamental frequency (150 Hz or 180 Hz), and so on.

Harmonics can be positive-sequence (+), zero-sequence (0) or negative-sequence (-). Positive-sequence harmonics try to run the motor faster than fundamental; negative-sequence harmonics try to run the motor slower than fundamental. In both cases the motor loses torque and heats up.

Order	F	2nd	3rd	4th	5th	6th	7th	8th	9th	10th	11th	etc.
Frequency	50	100	150	200	250	300	350	400	450	500	600	...
	60	120	180	240	300	360	420	480	540	600	660	...
Sequence	+	-	0	+	-	0	+	-	0	+	-	...

If waveforms are symmetrical, even harmonics disappear.

**Impulse (see Transient)**

**Inrush current**

The initial surge of current required by a load before resistance or impedance increases to its normal operating value.

**K-factor**

A number indicating losses in transformers due to harmonic currents. Higher order harmonics influence the k-factor more than lower order harmonics.

The following definition is used in the Fluke 43 for computing the K-factor:

$$KF = \frac{(h^2 \times I_h^2)}{I_h^2}$$

Where: h = harmonic order

I<sub>h</sub> = harmonic current as a percentage of the fundamental



**Nonlinear load**

Electrical loads in which the instantaneous current is not proportional to the instantaneous voltage. The load impedance varies with the voltage. Electronic loads, with diode/capacitor front-ends are nonlinear loads.

**Outage**

Long term power interruption, longer than 1 minute.

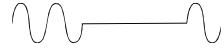

**Overvoltage**

The voltage is above its nominal value on a long term (longer than 10 cycles).



**Point of Common Coupling (PCC)**

Point where utility responsibility ends and building owner responsibility begins. Usually at the main transformer or at the revenue meter.

**Power Factor (PF)**

The ratio of real power to apparent power. Inductive loads cause current to lag behind voltage, while capacitive loads cause current to lead voltage. Also the presence of harmonic currents decrease the Power Factor.

The power factor uses the total rms value, thus including all harmonics, for its calculation. (see also: *Displacement Power Factor*)

PF	Interpretation
0 to 1	not all supplied power is consumed, reactive power present.
1	device is consuming all supplied power, no reactive power.
-1	device is generating power, current and voltage in phase.
-1 to 0	device generating power, current leads or lags.

**Reactive Power**

The Reactive Power (VAR) is the reactive component of the apparent power, caused by a phase shift between ac current and voltage in inductors (coils) and capacitors.

VARs are present in a distribution system as a result of inductive loads, such as motors, reactors, and transformers. VAR's are compensated for by correction capacitors.

**Real Power (see Active Power)**

**Sag**

A sag is a temporary voltage decrease caused by, for example, large equipment starting up or shutting down.



The duration is usually from one cycle to a few seconds.

**Spike (see Transient)****Surge (see see also Swell)**

The term surge is sometimes associated with lightning-related overvoltages.

**Swell**

A swell is a temporary voltage increase. The duration is usually from one cycle to a few seconds.

**Total Harmonic Distortion (THD)**

THD is the amount of harmonics in a signal as a percentage of the total RMS value (THD-R) or as a percentage of the fundamental (THD-F). It is a measure of the degree to which a waveform deviates from a purely sinusoidal form. 0% indicates that there is no distortion. You can select THD-R or THD-F in the instrument setup menu.

**Transient**

A very short and sharp increase or decrease in the voltage (or current) on a waveform.

(Also: impulse, spike)

**True Power (see Active Power)****Undervoltage**

The voltage is below its nominal value on a long term (longer than 10 cycles).

**VA (see Apparent Power)**

Volt Ampere

**VAR (see Reactive Power)**

Volt Ampere Reactive

**W (see Active Power)**

Watt

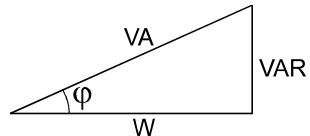

# Index

## —A—

Active Power, 75  
Adjustable Speed Drives, 51  
Apparent Power, 75  
AUTO, 1/2AUTO, 59

## —B—

Black out, 75  
Brown out, 75

## —C—

Capacitance, Measuring, 13  
Capacitive Loads, 75  
CF, Crest Factor, 6  
Continuity, Testing, 11  
Conventions, 2  
Cos  $\phi$  (DPF), 75  
Cos  $\phi$ , Measuring, 33  
Current and Voltage, Measuring, 8  
Current Imbalance, 40  
Current, Measuring, 7, 51  
Cursors, 5, 26

## —D—

Deleting Screens, 68  
Diodes, Testing, 14  
Displacement Power Factor, 75  
Displacement Power Factor,  
    Measuring, 33  
Documenting, 71  
Downstream, 20  
DPF (Cos  $\phi$ ), 75  
Dropout, 75

## —F—

Frequency Of Motor Current,  
    Measuring, 53

Frequency, Measuring, 6  
Fundamental Of Motor Voltage,  
    Measuring, 52  
Fuses, Testing, 11

## —H—

Harmonic  
    Component, 75  
    Distortion, 76  
    Order, 76  
Harmonics  
    Current, 22, 32  
    Negative-sequence, 76  
    Positive-sequence, 76  
    Voltage, 21, 50  
    Zero-sequence, 76

## —I—

Imbalance  
    Current, 40  
    Voltage, 38  
Impulse, 78  
Impulses, Detecting, 16  
Inductive Loads, 75  
Initial Settings, 4  
Inrush current, 76  
Inrush Current, Measuring, 32, 53

## —K—

KF, 76  
K-factor, 76  
K-factor, Measuring, 29

## —L—

Lighting Loads, 31  
Line Voltage, Measuring, 6

**—M—**

Main Menu, 2  
MANUAL, 61  
Motor Loads, 37

**—N—**

Negative Sequence Harmonics, 50  
Nonlinear load, 77

**—O—**

Oscilloscope, 55  
Outage, 77  
Overvoltage, 77

**—P—**

PCC, 23, 77  
Peak Current, 36, 46  
Point Of Common Coupling, 23, 77  
Positive Sequence Harmonics, 50  
Power  
    Active, 75  
    Apparent, 75  
    Reactive, 77  
    Real, 77  
    Single Phase, 33  
    True, 78  
Power Factor, 77  
Power Factor, Measuring, 47  
Printing Screens, 70

**—R—**

Reactive Power, 77  
Real Power, 77  
Receptacle Loads, 15  
Recording  
    One or Two Readings, 26  
    Sags and Swells, 9  
Report, Creating, 74  
Resistance, Measuring, 12

**—S—**

Safety Precautions, 1  
Sag, 77  
Sags & Swells, Recording, 9, 19

Saving Screens, 68  
Scope Reading, 58  
Screens  
    Deleting, 68  
    Printing, 70  
    Saving, 70  
    Using in Word, 71  
    Viewing, 68

Spike, 78  
Spikes, Detecting, 16  
Surge Current, 76, 78  
Surge Current, Measuring, 32  
Swell, 78

**—T—**

THD, 78  
Three Phase Balanced, 47  
Total Harmonic Distortion, 78  
    Current, 22, 32  
    Voltage, 21, 50  
Transformer  
    Measuring K-factor, 29  
    Measuring Load, 24  
Transient, 78  
Transients, Detecting, 16  
Triggering, 61  
True Power, 78

**—U—**

Undervoltage, 78  
Upstream, 20

**—V—**

VA, 78  
VAR, 78  
Viewing Screens, 68  
Voltage and Current, Measuring, 8  
Voltage Fluctuations, Recording,  
    19  
Voltage Imbalance, 36

**—W—**

W, 78