

# AC Power Meter

GPM-8212

---

## USER MANUAL

GW INSTRUMENT PART NO. 82PM-82120MB



ISO-9001 CERTIFIED MANUFACTURER **GW INSTRUMENT**

This manual contains proprietary information, which is protected by copyrights. All rights are reserved. No part of this manual may be photocopied, reproduced or translated to another language without prior written consent of Good Will company.

The information in this manual was correct at the time of printing. However, Good Will continues to improve products and reserves the rights to change specification, equipment, and maintenance procedures at any time without notice.

Good Will Instrument Co., Ltd.

No. 7-1, Jhongsing Rd., Tucheng City, Taipei County 236, Taiwan.

**TABLE OF CONTENTS**

**PAGE**

|                                                |           |
|------------------------------------------------|-----------|
| <b>1. SAFETY SUMMARY.....</b>                  | <b>1</b>  |
| <b>2. INTRODUCTION.....</b>                    | <b>5</b>  |
| <b>3. SPECIFICATION.....</b>                   | <b>6</b>  |
| <b>4. PANEL INTRODUCTION &amp; WIRING.....</b> | <b>8</b>  |
| <b>5. USAGE DESCRIPTION.....</b>               | <b>16</b> |
| <b>6. RS232 COMMUNICATION INTERFACE.....</b>   | <b>18</b> |
| <b>7. MAINTENANCE.....</b>                     | <b>21</b> |

---

## 1.SAFETY TERMS AND SYMBOLS

Please take a moment to review these safety terms and symbols which may appear in this manual or on Equipment to prevent damage to the Power Meter.



**WARNING.** Warning statements identify condition or practices that could result in injury or loss of life.



**CAUTION.** Caution statements identify conditions or practices that could result in damage to this product or other property.



**DANGER High Voltage**



**ATTENTION refer to Manual**



**Protective Conductor Terminal**



**(ground) Earth Terminal**



**Frame or Chassis Terminal**

---



---

## FOR UNITED KINGDOM ONLY

**NOTE: This lead/appliance must only be wired by competent persons**

**WARNING: THIS APPLIANCE MUST BE EARTHED**

**IMPORTANT: The wires in this lead are coloured in accordance with the following code:**

**Green/ Yellow: Earth**  
**Blue: Neutral**  
**Brown: Live(Phase)**

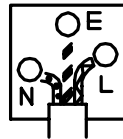

As the colours of the wires in main leads may not correspond with the colours marking identified in your plug/appliance, proceed as follows:

The wire which is coloured Green & Yellow must be connected to the Earth terminal marked with the letter E or by the earth symbol

 or coloured Green or Green & Yellow.

The wire which is coloured Blue must be connected to the terminal which is marked with the letter N or coloured Blue or

---



---

Black.

The wire which is coloured Brown must be connected to the terminal marked with the letter L or P or coloured Brown or Red.

If in doubt, consult the instructions provided with the equipment or contact the supplier.

This cable/appliance should be protected by a suitably rated and approved HBC mains fuse : refer to the rating information on the equipment and/or user instructions for details. As a guide, cable of 0.75mm<sup>2</sup> should be protected by a 3A or 5A fuse. Larger conductors would normally require 13A types, depending on the connection method used.

Any moulded mains connector that requires removal /replacement must be destroyed by removal of any fuse & fuse carrier and disposed of immediately, as a plug with bared wires is hazardous if a engaged in live socket. Any re-wiring must be carried out in accordance with the information detailed on this label.

## 2. INTRODUCTION

GPM-8212 Power Meter is a 16-bit CPU microprocessor equipped with multifunction of full-digitized measurement, calibration and output. The microprocessor has the advantage of high-speed sampling and calculation function to accurately measure the distortion signal of waveform. Except for its essential measurement on AC voltage, AC current, AC power, Power factor, and Frequency, the power meter also provides additional features of PT/CT ratio setting, display value holding, the value of maximum and minimum holding, range selecting, auto-ranging and etc.

In order for an even more efficient and convenient communication, the standard RS232 or RS485 is available as an option attached to the instrument.

The GPM-8212 is a low-cost, easy-to-use power measuring instrument.

## 3. SPECIFICATION

| <b>VOLTAGE</b>                                       |                                                                                                           |         |         |        |         |         |         |         |
|------------------------------------------------------|-----------------------------------------------------------------------------------------------------------|---------|---------|--------|---------|---------|---------|---------|
| Range                                                | 5.000V, 10.00V, 20.00V, 40.00V, 80.00V, 160.0V, 320.0V, 640.0V total 8 ranges by auto-range or manual.    |         |         |        |         |         |         |         |
| Measurement Type                                     | True rms                                                                                                  |         |         |        |         |         |         |         |
| Input Resistance                                     | $\geq 1M$                                                                                                 |         |         |        |         |         |         |         |
| Maximum Input Voltage                                | 1000V(peak), 700V(rms)                                                                                    |         |         |        |         |         |         |         |
| PT Ratio Setting                                     | 1 to 9999                                                                                                 |         |         |        |         |         |         |         |
| Accuracy (at 23°C $\pm 5^\circ\text{C}$ ) (Sinewave) | $\pm 0.1\%$ of reading $\pm 0.1\%$ of range                                                               |         |         |        |         |         |         |         |
| <b>CURRENT</b>                                       |                                                                                                           |         |         |        |         |         |         |         |
| Range                                                | 160.0mA, 320.0mA, 640.0mA, 1.280A, 2.560A, 5.120A, 10.24A, 20.48A total 8 ranges by auto-range or manual. |         |         |        |         |         |         |         |
| Measurement Type                                     | True rms                                                                                                  |         |         |        |         |         |         |         |
| Input Resistance                                     | 0.01                                                                                                      |         |         |        |         |         |         |         |
| Maximum Input Current                                | 30A (peak), 20A (rms)                                                                                     |         |         |        |         |         |         |         |
| CT Ratio setting                                     | 1 to 9999                                                                                                 |         |         |        |         |         |         |         |
| Accuracy(at 23°C $\pm 5^\circ\text{C}$ ) (Sinewave)  | $\pm 0.1\%$ of reading $\pm 0.1\%$ of range                                                               |         |         |        |         |         |         |         |
| <b>WATT</b>                                          |                                                                                                           |         |         |        |         |         |         |         |
| Range:                                               |                                                                                                           |         |         |        |         |         |         |         |
| W \ A                                                | 160.0mA                                                                                                   | 320.0mA | 640.0mA | 1.280A | 2.560A  | 5.120A  | 10.24A  | 20.48A  |
| V                                                    | 5.000V                                                                                                    | 10.00V  | 20.00V  | 40.00V | 80.00V  | 160.0V  | 320.0V  | 640.0V  |
|                                                      | 800.0mW                                                                                                   | 1.600W  | 3.200W  | 6.400W | 12.80W  | 25.60W  | 51.20W  | 102.4W  |
|                                                      | 1.600W                                                                                                    | 3.200W  | 6.400W  | 12.80W | 25.60W  | 51.20W  | 102.4W  | 204.8W  |
|                                                      | 3.200W                                                                                                    | 6.400W  | 12.80W  | 25.60W | 51.20W  | 102.4W  | 204.8W  | 409.6W  |
|                                                      | 6.400W                                                                                                    | 12.80W  | 25.60W  | 51.20W | 102.4W  | 204.8W  | 409.6W  | 819.2W  |
|                                                      | 12.80W                                                                                                    | 25.60W  | 51.20W  | 102.4W | 204.8W  | 409.6W  | 819.2W  | 1.638kW |
|                                                      | 25.60W                                                                                                    | 51.20W  | 102.4W  | 204.8W | 409.6W  | 819.2W  | 1.638kW | 3.276kW |
|                                                      | 51.20W                                                                                                    | 102.4W  | 204.8W  | 409.6W | 819.2W  | 1.638kW | 3.276kW | 6.553kW |
|                                                      | 102.4W                                                                                                    | 204.8W  | 409.6W  | 819.2W | 1.638kW | 3.276kW | 6.553kW | 13.10kW |
| Measurement Type                                     | True rms                                                                                                  |         |         |        |         |         |         |         |
| Accuracy(at 23°C $\pm 5^\circ\text{C}$ ) (Sinewave)  | $\pm 0.2\%$ of reading $\pm 0.2\%$ of range                                                               |         |         |        |         |         |         |         |

| POWER FACTOR            |                                                      |
|-------------------------|------------------------------------------------------|
| Range                   | 0.001 to 1.000                                       |
| Computation             | $W \div (V \times A) = \text{Power factor (PF)}$     |
| FREQUENCY               |                                                      |
| Measurement Range       | 40.0Hz to 400.0Hz                                    |
| Accuracy (23°C ±5°C)    | ±0.2% of reading ±2 digits                           |
| OPTION                  |                                                      |
| Communication           | RS-232, RS-485                                       |
| GENERAL                 |                                                      |
| Main Supply             | AC86~265V, 50/60Hz                                   |
| Warm up time            | 30 minutes more.                                     |
| Display                 | A 4-digit 0.56" LED with 2 sets of 4-digit 0.4" LED. |
| Minimum input           | 2% of Range                                          |
| Response time           | 2 cycles/sec                                         |
| Overload indicating     | "O.L"                                                |
| Working temperature     | 0~50°C, RH < 80%                                     |
| Temperature coefficient | ±0.1% FS/°C                                          |
| Accessories             | Instruction manual × 1, Power cord × 1, Disk × 1     |
| Dimension               | 250(W)×90(H)×281(D) m/m                              |
| Weigh                   | Approx. 1.6 kgs                                      |

**Note:** The 1.0mm<sup>2</sup> of cross-section dimension power cord should be used when the current reaches to 10 Amperes, and use 2.0mm<sup>2</sup> of cross-section dimension power cord when the current reaches to 20 Amperes.

#### 4. PANEL AND OUTLOOK INTRODUCTION

- Fig 4.1 FRONT PANEL

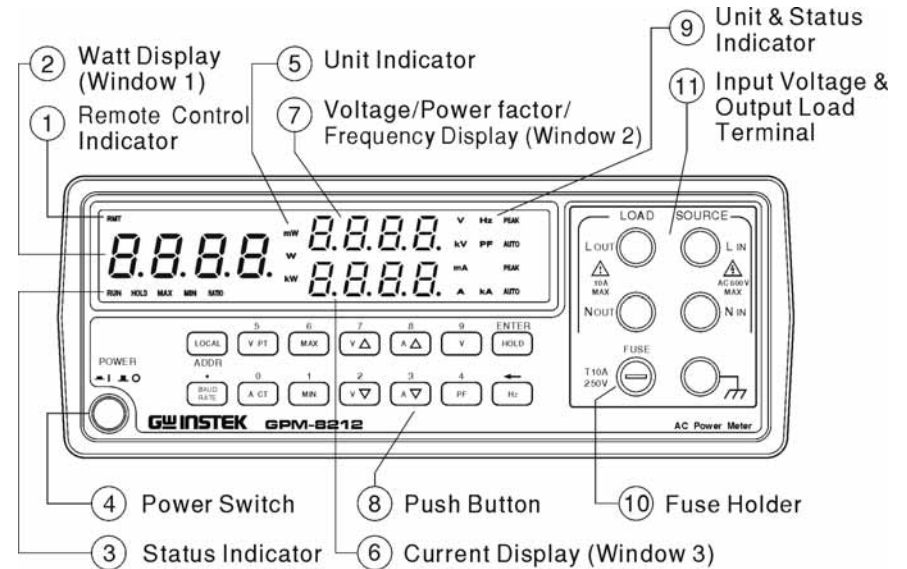

## 4-1.Function Description

### (1) Remote Control Indicator

**RMT**

Remote Control Indicator

### (3) Status Indicator

**RUN**

When the instrument is working normal, the RUN indicator is flashing stably, if not, it will be appeared constant on or off.

**HOLD**

The HOLD indicator is on when press the key of HOLD to maintain the display value not to be changed by any input.

**MAX**

The MAX indicator is on when press the key of MAX, the display then appears the maximum value it obtained.

**MIN**

The MIN indicator is on when press the key of MIN, the display then appears the minimum value it obtained.

**RATIO**

The indicator is on when the value of PT and CT is set to other value except 1.

### (5) Unit Indicator

**mW**

Display Window 【1】 Milliwatt indicator.

**W**

Display Window 【1】 Watt indicator.

**kW**

Display Window 【1】 Kilowatt indicator.

### (9) Unit & Status Indicator

**V**

Display Window 【2】 Volt indicator.

**kV**

Display Window 【2】 Kilovolt indicator.

**PF**

Display Window 【2】 Power Factor indicator.

**Hz**

Display Window 【2】 Hertz indicator.

**mA**

Display Window 【3】 Milliampere indicator.

**A**

Display Window 【3】 Ampere indicator.

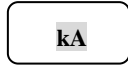

Display Window 【3】 Kiloampere indicator.

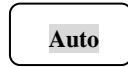

Display Window 【2】 Auto-range indicator. The indicator is on when the window of voltage measurement is set to auto-range. The voltage measurement will be auto-ranged following the change of external voltage.

Display Window 【3】 Auto-range indicator. The indicator is on when the window of current measurement is set to auto-range. The current measurement will be auto-ranged following the change of external current.

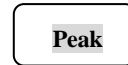

Window 【2】 for voltage Peak indicator. The Vpeak indicator is on when the input voltage peak is larger than the measurement of voltage range.

**\*If the Vpeak indicator is illustrated with manual ranging, switch range by using  $\Delta$ V button.**

Window 【3】 for current Peak indicator. The Apeak indicator is on when the input current peak is larger than the measurement of current range.

**\*If the Apeak indicator is illustrated with manual ranging, switch range by using  $\Delta$ A button.**

## (8) Pushbuttons



Set up address for RS-458 interface only.

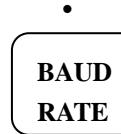

*Number key.*

Set interface baudrate with 1200, 2400, 4800 and 9600 bps available for selection.

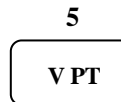

*Number key.*

Set PT Ratio range at 1~9999.

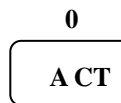

*Number key.*

Set CT Ratio range at 1~9999.

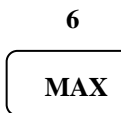

*Number key.*

Set to the maximum value of the display, then press the button again back to previous status.

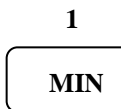

*Number key.*

Set to the minimum value of the display, then press the button again back to previous status.

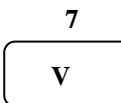

*Number key.*

Set the voltage range upward, press and hold the button for 2 seconds to enter autorange of voltage.

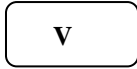
**2***Number key.*

Set the voltage range downward, press and hold the button for 2 seconds to enter autorange of voltage.

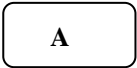
**8***Number key.*

Set the current range upward, press and hold the button for 2 seconds to enter autorange of voltage.

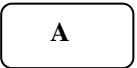
**3***Number key.*

Set the current range downward, press and hold the button for 2 seconds to enter autorange of current.

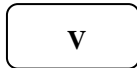
**9***Number key.*

Set Window **【2】** to indicate Voltage function.

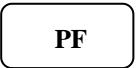
**4***Number key.*

Set Window **【2】** to indicate power factor function.

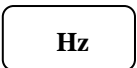
*Back key.*

Set Window **【2】** to indicate frequency function.

**ENTER***Enter key.*

Maintain the present display value.

● **Fig. 4-2 REAR PANEL**

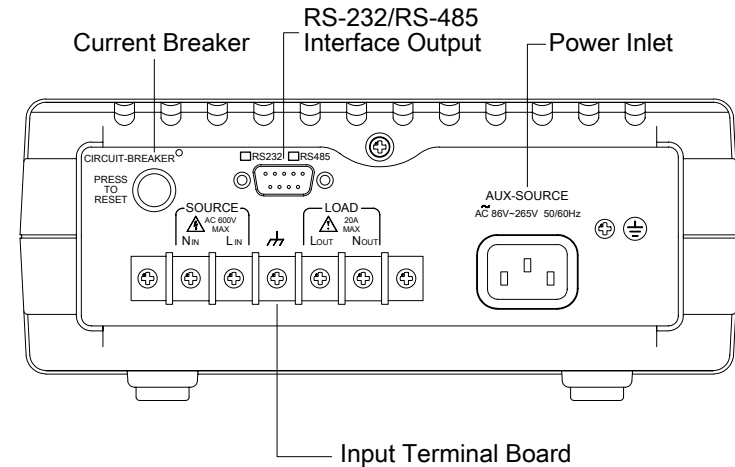

**\*\*Current Breaker: This is an Over-current protected component. When the measurement is interrupted with over current input, please reduce the measured load, then re-switch on, the measurement can be back to normal.**

#### 4-2. Wiring

- Without PT or CT:

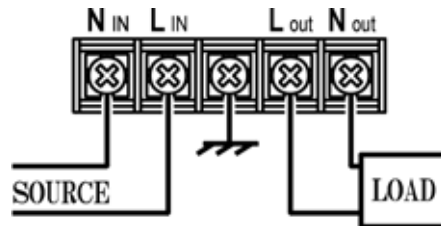

- With CT

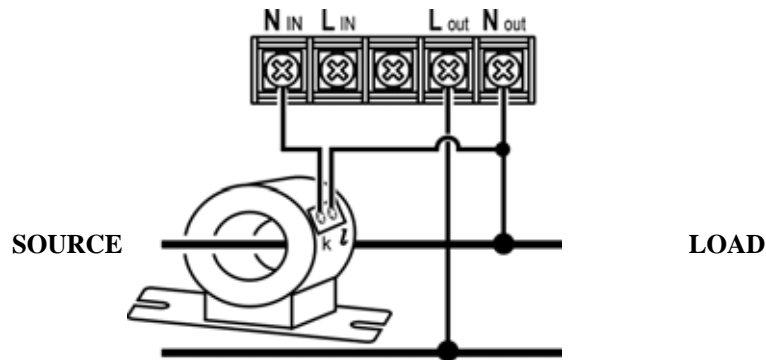

**WARNING:** Make sure that the source power is off before any wiring connection.



**WARNING:** Make sure that all connectors are well connected before the source power is on.

#### 5. USAGE DESCRIPTION

- Baudrate setting

- 1) Press the button of Baud to appear the letter of BAUD on the window 2, window 3 indicates the previous setting parameters, and window 1 appears "-----". If no further action, it will return to previous test mode within 5 seconds, or press [Back] button directly.
- 2) Then proceed the following steps to set the desired parameters, such as 1200:
  - Press [1] to appear 1---
  - Press [2] to appear 12--.
  - Press [0] to appear 120-.
  - Press [0] to appear 1200.
- 3) If there is any mistake, press [←] key to erase front error numbers.
- 4) After pressing [ENTER] to save the information, return to test mode.

- Address setting

- 1) Press [Addr] to appear ADDR on the window 2, window 3 indicates previous setting parameters and window 1 appears "——". If no further action, it will return to previous test mode within 5 seconds, or press [Back] button directly.
- 2) Then proceed the following steps to set the desired parameters, such as 10:
  - Press [1] to appear 1-.
  - Press [0] to appear 10.
- 3) If there is any mistake, press [←] key to erase front error numbers.
- 4) After pressing [ENTER] to save the information, return to test mode.

- **PT Ratio setting**

- 1) Press the button of [VPT] to appear the letters of PT on the window 2, window 3 indicates the previous setting parameter, and window 1 appears "-----". If no further action, it will return to previous test mode within 5 seconds, or press [←] key directly.
- 2) Then proceed the following steps to set the desired parameters, such as 1000:
  - Press [1] to appear 1---
  - Press [0] to appear 10--.
  - Press [0] to appear 100-.
  - Press [0] to appear 1000.
- 3) If there is any mistake, press [←] key to erase front error numbers.
- 4) After pressing [ENTER] to save the information, return to test mode.

- **CT Ratio setting**

- 1) Press the button of [ACT] to appear the letters of CT on the window 2, window 3 indicates the previous setting parameters, and window 1 appears "-----". If no further action, it will return to previous test mode within 5 seconds, or press [←] key directly.
- 2) Then proceed the following steps to set the desired parameters, such as 1000:
  - Press [1] to appear 1---
  - Press [0] to appear 10--.
  - Press [0] to appear 100-.
  - Press [0] to appear 1000.
- 3) If there is any mistake, press [←] key to erase front error numbers.
- 4) After pressing [ENTER] to save the information, return to test mode

## 6. RS232 COMMUNICATION INTERFACE

- **Introduction**

The instrument can be operated from a host (eg. A terminal controller, computer, PLC...) by sending commands through a computer interface on the rear panel.

- **Communication parameter**

Baudrate : 1200, 2400, 4800, 9600 bps.  
 Parity : None  
 Data bits : 8  
 Stop bit : 1

- **Wire drawing : Located in the rear panel of GPM-8212.**

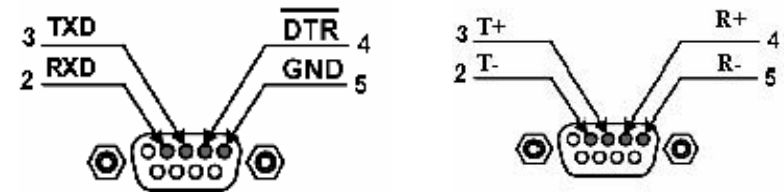

RS-232

RS-485

**Pin 232:**

| SIGNAL | $\overline{\text{CD}}$ | RXD | TXD | $\overline{\text{DTR}}$ | GND | $\overline{\text{DSR}}$ | $\overline{\text{RTS}}$ | $\overline{\text{CTS}}$ | RI |
|--------|------------------------|-----|-----|-------------------------|-----|-------------------------|-------------------------|-------------------------|----|
| 9 PIN  | 1                      | 2   | 3   | 4                       | 5   | 6                       | 7                       | 8                       | 9  |
| 25PIN  | 8                      | 3   | 2   | 20                      | 7   | 6                       | 4                       | 5                       | 22 |

**Pin 485:**

| SIGNAL  | NC | TxD | TxD | RxD | RxD | NC | NC | NC | NC |
|---------|----|-----|-----|-----|-----|----|----|----|----|
|         |    | -   | +   | +   | -   |    |    |    |    |
| PIN No. | 1  | 2   | 3   | 4   | 5   | 6  | 7  | 8  | 9  |

- **Communication command**

| COMMAND | DESCRIPTION           | EXAMPLE |
|---------|-----------------------|---------|
| F00     | Data hold enable      |         |
| F01     | Data hold disable     |         |
| F02     | Set in maximum status |         |
| F03     | Set in minimum status |         |
| F04     | Set in normal status  |         |
| R00     | V Range=640.0V        |         |
| R01     | V Range=320.0V        |         |
| R02     | V Range=160.0V        |         |
| R03     | V Range=80.00V        |         |
| R04     | V Range=40.00V        |         |
| R05     | V Range=20.00V        |         |
| R06     | V Range=10.00V        |         |
| R07     | V Range=5.000V        |         |
| R08     | A Range=20.48A        |         |
| R09     | A Range=10.24A        |         |
| R10     | A Range=5.120A        |         |
| R11     | A Range=2.560A        |         |
| R12     | A Range=1.280A        |         |
| R13     | A Range=640.0mA       |         |
| R14     | A Range=320.0mA       |         |
| R15     | A Range=160.0mA       |         |
| R16     | V Range=Autorange     |         |
| R17     | A Range=Autorange     |         |
| S00     | Set Voltage Ratio(PT) | S00:1   |
| S01     | Set Current Ratio(CT) | S01:1   |
| V00     | Read Voltage          |         |
| V01     | Read Current          |         |
| V02     | Read Watt             |         |
| V03     | Read PF               |         |
| V04     | Read Hz               |         |

- **DEMO Program**

; Demo program language: BASIC  
 ; Computer set Baudrate equal 9600, and use COM2  
 ; The GPM-8212 set Baudrate equal 9600  
 ; Command define in CMD\$

```

10CMD$= "V00"
20VALUE$= " "
30OPEN "COM2:9600,N,8,,CS,DS,CD" FOR RANDOM AS#2 LEN=1
40FOR I= 1 TO 100
50PRINT #2, CMD$
60INPUT #2, VALUE$
70PRINT VALUE$
80NEXT I
90CLOSE #2
100END

```

## 7. MAINTENANCE

The following instructions are used by qualified person only to avoid electrical shock, do not perform any service other than contained in the operation instructions unless you are qualified to do so.

### 7-1.Fuse Rating and type

If the fuse is ruptured, the Power METER will not operate. Try to determine and correct the cause of the blown fuse, then replace the fuse with correct rating and type shown as below:

| MODEL    | FUSE Rating and Type    | Rating Input |    |
|----------|-------------------------|--------------|----|
|          |                         | Watts        | VA |
| GPM-8212 | 115V/230V<br>T0.5A 250V | 22           | 28 |



**WARNING: For continued fire protection, replace only with 250V fuse of the specified type and rating, and disconnect the power cord before proceeding fuse replacement.**

### 7-2.Fuse Replacement Procedure

When you proceed calibration or maintenance of the Power Meter, if you want to replace the fuse, the upper cover must be removed according to the following steps:

- 1).The handle must be turned downward 90 degrees first.

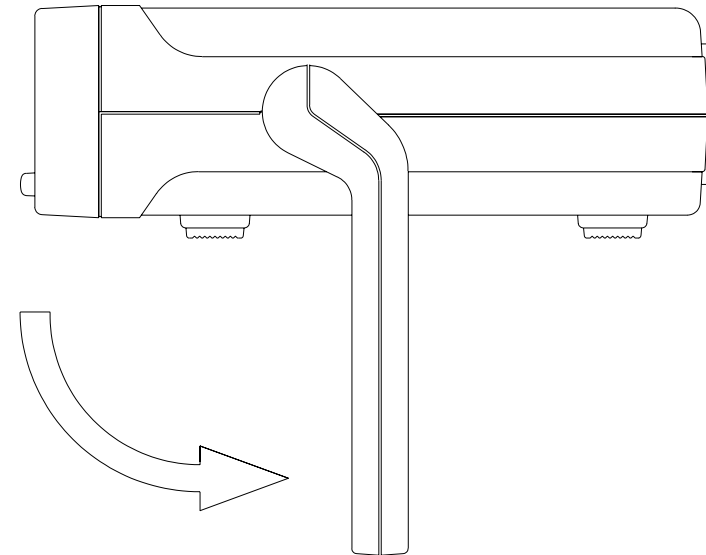

- 2). Pull apart the handle from the Power Meter. Please turn the handle left and right side slightly, that will make it easier to pull off the handle.

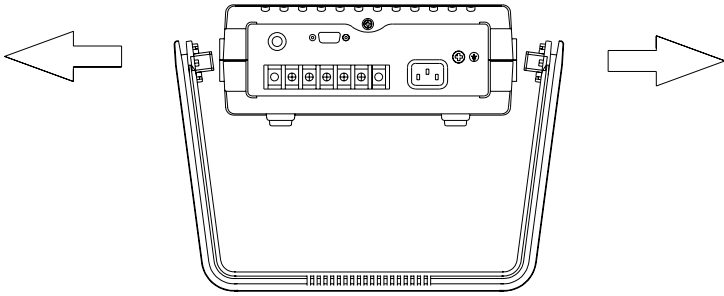

- 3). There are two washers inside of two holes (the joints of handle and case) respectively. Please use a screwdriver to pry open these washers.

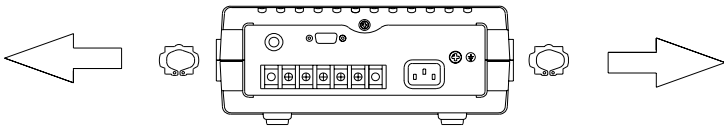

- 4). Please use a screwdriver to open the screw located at upper side of rear panel. Therefore, the upper cover can pull toward the backside. In the meantime, the upper cover is moved.

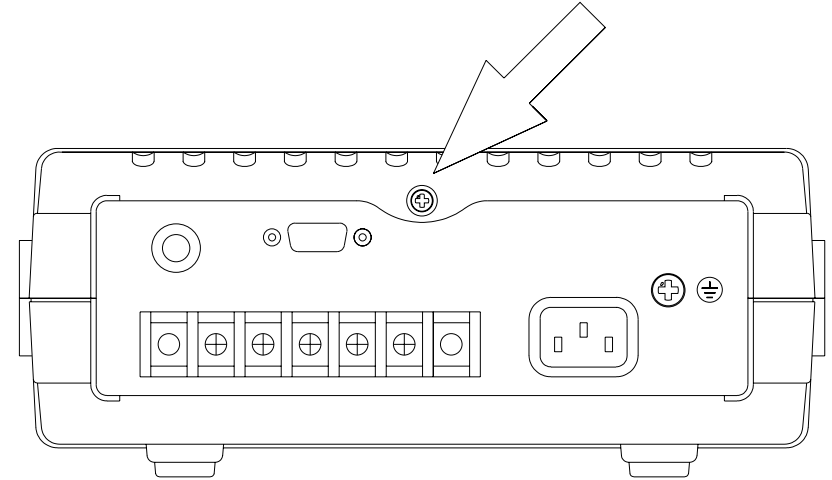

**Note: If you want to install the upper cover, please reverse above steps.**

### 7-3. Cleaning

To keep the instrument clean, wipe the case with a damp cloth and detergent. Do not use abrasives or solvents.