

# GPP-Series

## Multi-output Programmable D.C. Power Supply

### FEATURES

- 4.3" TFT LCD Display
- Supports Setting Value, Measurement Value and Output Waveform Display
- Load Function (CC, CV, CR Mode)
- Setting Resolution: 1mV/0.1mA ; Read Back Resolution: 0.1mV/0.1mA
- Low Ripple Noise:  $\leq 350\mu\text{Vrms}/\leq 2\text{mArms}$
- Transient Response Time:  $\leq 50\mu\text{s}$
- Tracking Series and Parallel Function without Additional External Wiring
- Utilizing Hardware to Realize Over Voltage Protection/Over Current Protection/Over Temperature Protection
- Delay Function/Output Monitoring Function/Output Recorder Function
- Intelligent Temperature Control Fan Effectively Reduces Noise
- Sequential Output Function and Built-in 8 Template Waveforms
- The Output Recorder Function Records The Output Voltage & Current Parameters with A Minimum Recording Interval of 1 Second
- Provides 10 Sets of Memory for Each Sequence/Delay/Recorder/Panel Setting Condition
- GPP-3323 Supports A USB(Type A) Output Terminal
- Standard: RS-232, USB, Ext I/O ; Optional(Manufacturer Installed Only): LAN, GPIB+LAN
- Compatible with Commands of GPD-X303S Series

**GW INSTEK**  
Simply Reliable

With the maximum output power of 217W, the GPP-Series, the multi-channel programmable DC power supply, includes four models: GPP-1326 (0~32V/0~6A) for single-channel output and GPP-2323 for dual-channel output (CH1:0~32V/0~3A, CH2: 0~32V/0~3A), GPP-3323 for three-channel output (CH1: 0~32V/0~3A, CH2:0~32V/0~3A, CH3: 1.8V, 2.5V, 3.3V, 5.0V/5A) and GPP-4323 for four-channel output (CH1:0~32V/0~3A, CH2:0~32V/0~3A, CH3:0~5V/0~1A, CH4: 0~15V/0~1A). This series not only provides high program resolution (1mV/0.1mA) and read back resolution (0.1mV/0.1mA), but also features optimal low-ripple noise characteristics  $\leq 350\mu\text{Vrms}/\leq 2\text{mA rms}$  and output transient recovery capability  $\leq 50\mu\text{s}$ . Independent output on-off switch is provided for each channel.

For series and parallel applications of CH1 and CH2, the tracking function of the GPP-Series utilizes the internal circuit to automatically switch the output to serial or parallel output without additional external wiring, providing users with convenience not only in operating procedures but also a more stable output. The tracking function design of other brands requires additional external wiring connections for the output in series or parallel. However, excessively long, thin or inconsistent external wiring may cause inaccurate voltage or current output.

The GPP-Series offers a variety of display modes, including single or multi-channel setting values, measurement values, and waveform displays. The Monitor function of the GPP-Series allows users to set monitoring conditions according to requirements, sound alarms or stop output during the measurement process, and stop measurement and protect the customer's DUT. The GPP-Series provides output recorder function, which records the voltage/current of the output process to the internal memory, and the result can be stored as a (\*.REC) or (\*.CSV) file, which can then be transferred to the USB flash drive. The stored \*.CSV can be exported to the Excel to conduct the future analysis.

The CH1/CH2 of the GPP-Series are designed with the load function. A single power supply can set one channel as the power output, and one channel for the load function to consume the power of the DUT so as to meet the basic charging and discharging test requirements for battery. Channel 1 and channel 2 not only provide 32V/3A power output, but also feature built-in maximum 32V constant voltage load (CV), maximum 3.2A constant current load (CC) and maximum 1k $\Omega$  constant resistance load (CR) function.

The GPP-Series provides the sequential output function on Channel 1 and Channel 2. This function not only allows users to edit the power output waveform, but also allows users to set the sequential constant voltage (CV) or constant current (CC) load waveform, i.e. a serial power output or a simulation test of a dynamic load. In order to simplify the setting of waveform editing, the GPP-Series has 8 built-in Templet waveforms in the sequence output function for users to directly apply for output, including Sine, Pulse, Ramp, Stair Up, Stair Dn, Stair UpDn, Exp Rise, Exp Fall waveforms.

The sound protection functions include OVP/OCP/OPP/OTP, in which the protection mechanism for OVP/OCP/OTP is implemented by hardware circuit that has the advantage of faster response time compared with competitors who adopt software to achieve protections. The OVP/OCP functions allow users to set the protection action point (except CH3 of GPP-3323) according to the conditions of the DUT. The OPP is only activated during the operation of the load function. The Delay Function sets the length of time during channel 1 or channel 2 power output on or during power output off.

In addition, the Trigger In/ Trigger Out functions synchronize external devices. The GPP-3323 channel 3 adds a 3A USB (Type A) output terminal for USB charging test. The intelligent temperature-controlled fan can adjust the speed according to the temperature of the power transistor so as to reduce unnecessary noise. The output value setting and the Sequence/Delay/Recorder functions provide 10 sets of internal memory for use, and can be loaded/stored using a USB flash drive. In addition to the standard RS-232 and USB remote interfaces, the GPP-Series also has an optional LAN or LAN+GPIB interface to facilitate different requirements. The commands of the GPP-Series conform to SCPI requirements and are compatible with the commands of the GPD-X303S Series.



GPP-1326



GPP-2323



GPP-3323



GPP-4323

## A. TRACKING SERIES AND PARALLEL FUNCTION

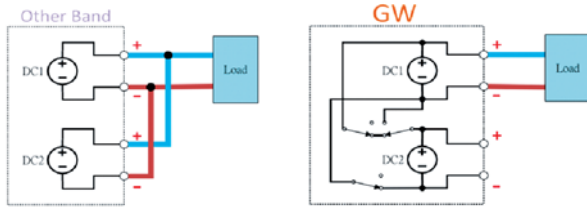

Output in Parallel Connections

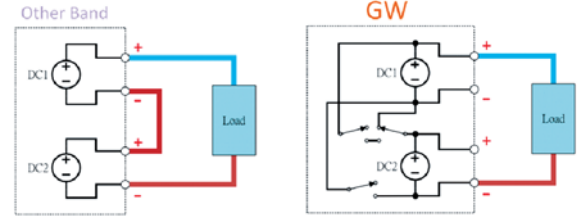

Output in Series Connections

For series and parallel applications of CH1 and CH2, the tracking function of the GPP-Series utilizes the internal circuit to automatically switch the output to serial or parallel output without additional external wiring, providing users with convenience not only in operating procedures but also a more stable output.

The tracking function design of other brands requires additional external wiring connections for the output in series or parallel. However, excessively long, thin or inconsistent external wiring may cause inaccurate voltage or current output.

## B. OUTPUT MONITORING FUNCTION

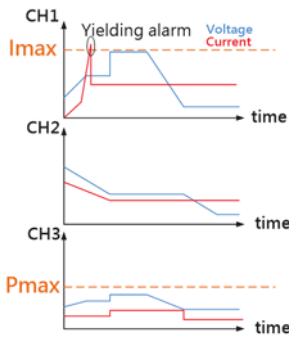

Output Monitoring



Monitoring Function Setting

The output monitoring function allows users to set the monitoring conditions according to the requirements, including the voltage, current, and power greater than or less than the setting and the logical relationship of AND, OR. It also allows users to sound

alarms or stop the output during the measurement process, stop the measurement, and protect the customer's DUT. Each Channel could be monitored simultaneously as well.

\* Channel 3 of GPP-3323 does not support the output monitoring function.

## C. SEQUENCE OUTPUT FUNCTION

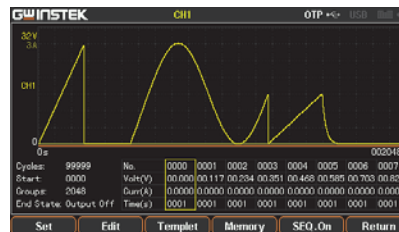

Output Waveform of the GPP-X323 Series

The GPP-Series provides a sequential output function on Channel 1 and Channel 2. This function not only allows users to edit the power output waveform, but also allows users to set the sequential constant voltage (CV) or constant current (CC) load waveform, i.e. a serial power output or a simulation test of a dynamic load. The maximum settable points for sequence function are 2048, and interval range of each point can be set from 1 to 300 seconds. In order to simplify the setting of waveform editing, the GPP-Series has 8 built-in Templet waveforms in sequence output function for

users to directly apply for output, including Sine, Pulse, Ramp, Stair Up, Stair Dn, Stair UpDn, Exp Rise, and Exp Fall waveforms.

The editing data of the sequence output can be stored in the internal 10 sets of the memory, or to be saved by USB flash drive (Save/Recall) and saved as \*.SEQ or \*.CSV file; The stored \*.SEQ can be exported into Excel for editing and analysis. The final edited file can be imported to (Save/Recall) of the power supply using a USB flash drive.

## D. HARDWARE PROTECTION FUNCTION (OVP/OCV/OTP)

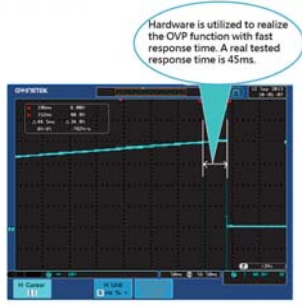

OVP Trigger

The protection mechanism of OVP/OCV/OTP is implemented by hardware circuit, which has the advantage of faster response time than competitors who use software to achieve protection. When it is detected that the voltage of the DUT exceeds the setting value of the OVP, the output of the power supply can be stopped in a short time to achieve the purpose of protecting the DUT.

## E. LOAD FUNCTION

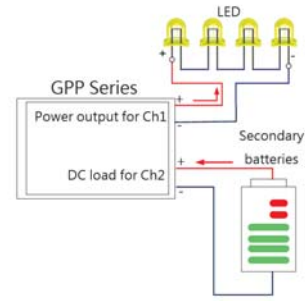

GPP-Series Application

The CH1/CH2 of the GPP-Series is designed with the load function. A single power supply can meet the basic battery charging and discharging test requirements. It can provide 32V/3A power output in channel 1 and channel 2. The maximum 32V constant voltage load (CV), maximum 3.2A constant current load (CC) and maximum 1kΩ constant resistance load (CR) function are built-in to allow users do conduct discharging test without using an electronic load. In application, users can also set either that one channel of the single GPP series as the power output, one channel as the load function to consume the power of the DUT, or that both channels as load functions to consume the power of different loads simultaneously.

## F. OUTPUT DELAY FUNCTION

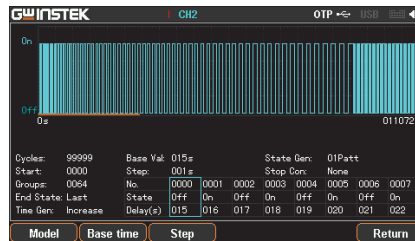

GPP-Series Delayed Waveform

Output delay function allows users to edit the timing waveform of the power output on/off when the front panel voltage and current settings are unchanged. In order to simplify the setting of waveform editing, the GPP-Series has three built-in timing modes in the delay output function, including Fixtime, Increase, Decline for users to apply directly. The editing data of the output delay can be stored in

the internal 10 sets of memory, or to be saved by USB flash drive (Save/Recall) and saved as \*.DLY or \*.CSV file. The stored \*.CSV can be exported into Excel for editing and analysis. The final edited file can be exported to (Save/Recall) of the power supply using a USB flash drive.

## G. OUTPUT RECORDER FUNCTION

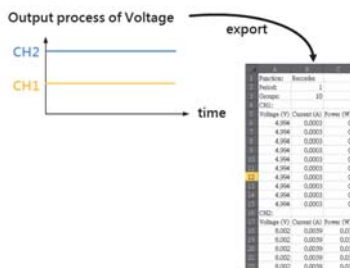

Recorder Function Setting



Save as \*.REC

The output recorder function records the voltage & current parameters of the output process. The recording interval of each point can be set according to user's requirements, and the shortest interval is 1 second and the longest is 300 seconds. The results can be stored in \*.REC or \*.CSV format to the power supply or directly

saved in the USB flash drive. The stored \*.CSV can be exported into Excel to conduct the future analysis. (\*.REC can be saved to 2018 records, \*.CSV can be saved to 614400 records)

\* Channel 3 of GPP-3323 does not support the output recorder function

## PANEL INTRODUCTION

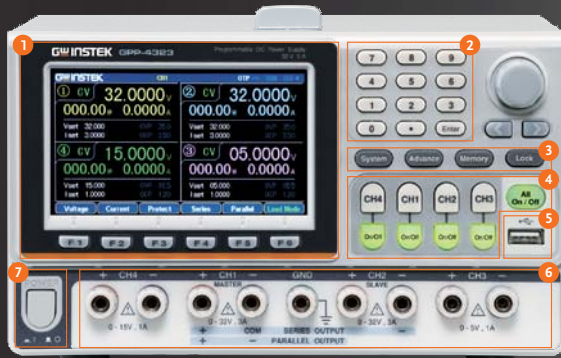

1. LCD Display
2. Number Pad
3. Function Keys
4. Output Buttons
5. USB Host
6. Front Panel Output Terminals
7. Power Button
8. Power Output Terminal (GPP-3323 only)
9. AC Selector Switch
10. AC Input Socket and Line Fuse
11. RS-232 Port
12. USB Device Port
13. Ext I/O Port
14. GPIB Port
15. LAN Port

## OPERATING RANGE

Model Number	Number of Outputs	CH1	CH2	CH3	CH4
GPP-1326	1	0-32V/0-6A			
GPP-2323	2	0-32V/0-3A	0-32V/0-3A		
GPP-3323	3	0-32V/0-3A	0-32V/0-3A	1.8V/2.5V/3.3V/5V; 5A	
GPP-4323	4	0-32V/0-3A	0-32V/0-3A	0-5V/0-1A	0-15V/0-1A

## OUTPUT FUNCTION LIST

Model Number	GPP-4323			
	GPP-3323			
	GPP-2323			
	GPP-1326			
	CH1	CH2	CH3	CH4
Number of Outputs	CH1	CH2	CH3	CH4
Sequence Output function	✓	✓		
Load Functions(CC, CV, CR mode)	✓	✓		
Output Delay function	✓	✓		
Output Monitoring Monitor(10 sets)	✓	✓	✓ (GPP-3323 not supported)	✓
Output Recorder Function	✓	✓	✓ (GPP-3323 not supported)	✓
Panel Save/ Recall	✓	✓	✓	✓

## SPECIFICATIONS

		GPP-4323				GPP-3323			GPP-2323		GPP-1326
OUTPUT MODE	Number of Channel	CH1	CH2	CH3	CH4	CH1	CH2	CH3	CH1	CH2	CH1
	Voltage	0~32V	0~32V	0~5V	0~15V	0~32V	0~32V	1.8/2.5/3.3/5.0V	0~32V	0~32V	0~32V
	Current	0~3A	0~3A	0~1A	0~1A	0~3A	0~3A	5A	0~3A	0~3A	0~6A
	Tracking Series Voltage	0~64V				0~64V			0~64V		-
	Tracking Parallel Current	0~6A				0~6A			0~6A		-
CONSTANT VOLTAGE OPERATION	Line Regulation	$\leq 0.01\%+3mV$									
	Load Regulation	$\leq 0.01\%+3mV$ (rating current $\leq 3A$ ); $\leq 0.02\%+5mV$ (rating current $> 3A$ )									
	Ripple & Noise(5Hz~1MHz)	$\leq 350\mu V_{rms}$	$\leq 1mV_{rms}$	$\leq 350\mu V_{rms}$	$\leq 2mV_{rms}$	$\leq 350\mu V_{rms}$	$\leq 2mV_{rms}$	$\leq 350\mu V_{rms}$	$\leq 500\mu V_{rms}$	$\leq 500\mu V_{rms}$	$\leq 500\mu V_{rms}$
	Recovery Time	$\leq 50\mu s$	$\leq 50\mu s$	$\leq 50\mu s$	$\leq 100\mu s$	$\leq 50\mu s$	$\leq 100\mu s$	$\leq 50\mu s$	$\leq 100\mu s$	$\leq 100\mu s$	
CONSTANT CURRENT OPERATION	Line Regulation	$\leq 0.2\%+3mA$									
	Load Regulation	$\leq 0.2\%+3mA$									
	Ripple & Noise	$\leq 2mArms$				$\leq 2mArms$			$\leq 2mArms$		$\leq 4mArms$
PROGRAMMING RESOLUTION	Voltage	1mV				1mV	-	-	1mV		1mV
	Current	0.1mA				0.1mA	-	-	0.1mA		0.2mA
TRACKING OPERATION (CH1,CH2)	Tracking Error	$\leq 0.1\%+10mV$ of Master(0~32V, No Load, with Load add Load regulation $\leq 100mV$ )									
	Parallel Regulation	Line : $\leq 0.01\%+3mV$ Load : $\leq 0.01\%+3mV$ (rating current $\leq 3A$ ); $\leq 0.02\%+5mV$ (rating current $> 3A$ )									
	Series Regulation	Line : $\leq 0.01\%+5mV$ ; Load : $\leq 100mV$									
	Ripple & Noise	$\leq 1mV_{rms}$ , 5Hz ~ 1MHz									
CH3 OPERATION FOR (GPP-3323)	Output Voltage	1.8V/2.5V/3.3V/5.0V, $\pm 5\%$									
	Output Current	5A									
	Line Regulation	$\leq 3mV$									
	Load Regulation	$\leq 5mV$									
	Ripple & Noise	2mVrms(5Hz~1MHz)									
	Transient Recovery Time	100 $\mu s$									
	USB Port Output	1.8V/2.5V/3.3V/5.0V, $\pm 0.35V$ , 3A									
METER	Voltage Resolution	0.1mV				0.1mV	-	-	0.1mV		0.1mV
	Current Resolution	0.1mA				0.1mA	-	-	0.1mA		0.2mA
	Setting Accuracy	$\leq \pm(0.03\%+10mV)$ $\leq \pm(0.30\%+10mA)$				$\leq \pm(0.03\%+10mV)$ $\leq \pm(0.30\%+10mA)$	-	-	$\leq \pm(0.03\%+10mV)$ $\leq \pm(0.30\%+10mA)$		$\leq \pm(0.03\%+10mV)$ $\leq \pm(0.30\%+10mA)$
	Readback Accuracy	$\leq \pm(0.03\%+10mV)$ $\leq \pm(0.30\%+10mA)$				$\leq \pm(0.03\%+10mV)$ $\leq \pm(0.30\%+10mA)$	-	-	$\leq \pm(0.03\%+10mV)$ $\leq \pm(0.30\%+10mA)$		$\leq \pm(0.03\%+10mV)$ $\leq \pm(0.30\%+10mA)$
DC LOAD CHARACTERISTIC	Channel	2				2	-	-	2		1
	Display Power	0~50.00W				0~50.00W	-	-	0~50.00W		0~100.00W
	Display Voltage	1~33.00V				1~33.00V	-	-	1~33.00V		1~33.00V
	Display Current	0~3.200A				0~3.200A	-	-	0~3.200A		0~6.200A
	CV Mode Setting Range	1.500V~33.00V				1.500V~33.00V	-	-	1.500V~33.00V		1.500V~33.00V
	Resolution	10mV				10mV	-	-	10mV		10mV
	Set Accuracy	$\leq 0.1\%+30mV$				$\leq 0.1\%+30mV$	-	-	$\leq 0.1\%+30mV$		$\leq 0.1\%+30mV$
	Read Accuracy	$\leq 0.1\%+30mV$				$\leq 0.1\%+30mV$	-	-	$\leq 0.1\%+30mV$		$\leq 0.1\%+30mV$
	CC Mode Setting Range	0~3.200A				0~3.200A	-	-	0~3.200A		0~6.200A
	Resolution	1mA				1mA	-	-	1mA		1mA
	Set Accuracy	$\leq 0.3\%+10mA$				$\leq 0.3\%+10mA$	-	-	$\leq 0.3\%+10mA$		$\leq 0.3\%+10mA$
	Read Accuracy	$\leq 0.3\%+10mA$				$\leq 0.3\%+10mA$	-	-	$\leq 0.3\%+10mA$		$\leq 0.3\%+10mA$
CR Mode Setting Range	1~1k $\Omega$				1~1k $\Omega$	-	-	1~1k $\Omega$		1~1k $\Omega$	
Resolution	1 $\Omega$				1 $\Omega$	-	-	1 $\Omega$		1 $\Omega$	
Set Accuracy	$\leq 0.3\%+1\Omega$ (Voltage $\geq 0.1V$ , and current $\geq 0.1A$ )				$\leq 0.3\%+1\Omega$ (Voltage $\geq 0.1V$ , and current $\geq 0.1A$ )	-	-	$\leq 0.3\%+1\Omega$ (Voltage $\geq 0.1V$ , and current $\geq 0.1A$ )		$\leq 0.3\%+1\Omega$ (Voltage $\geq 0.1V$ , and current $\geq 0.1A$ )	
Read Accuracy	$\leq 0.3\%+1\Omega$ (Voltage $\geq 0.1V$ , and current $\geq 0.1A$ )				$\leq 0.3\%+1\Omega$ (Voltage $\geq 0.1V$ , and current $\geq 0.1A$ )	-	-	$\leq 0.3\%+1\Omega$ (Voltage $\geq 0.1V$ , and current $\geq 0.1A$ )		$\leq 0.3\%+1\Omega$ (Voltage $\geq 0.1V$ , and current $\geq 0.1A$ )	
INSULATION	Chassis and Terminal	20M $\Omega$ or above (DC 500V)									
	Chassis and AC Cord	30M $\Omega$ or above (DC 500V)									
ENVIRONMENT CONDITION	Operation Temp	0~40 $^{\circ}C$									
	Storage Temp	-10~70 $^{\circ}C$									
	Operating Humidity	$\leq 80\%$ RH									
	Storage Humidity	$\leq 70\%$ RH									
EXTERNAL CONTROL	Yes										
INTERFACE	Std: RS-232/USB(CDC), Opt(Manufacturer installed only): LAN/ GPIB+LAN										
POWER SOURCE	AC100V/120V/220V/230V $\pm 10\%$ , 50/60Hz										
DIMENSION & WEIGHT	213(W) x 145(H) x 312(D) mm ; Approx. 7.5kg										

Specifications subject to change without notice. GPP-SeriesGD1BH\_201809-2000

## ORDERING INFORMATION

GPP-1326	(32V/6A) Single-Output Programmable DC Power Supply
GPP-2323	(32V/3A*2) Dual-Output Programmable DC Power Supply
GPP-3323	(32V/3A*2; 1.8V or 2.5V or 3.3V or 5V/5A*1) Three-Output Programmable DC Power Supply
GPP-4323	(32V/3A*2; 5V/1A; 15V/1A) Four-Output Programmable DC Power Supply

## ACCESSORIES

User Manual x 1 , Power cord x 1	
GPP-1326 Test Lead GTL-104A x 1, GTL-105A x 1	GPP-2323 Test Lead GTL-104A x 2
GPP-4323 Test Lead GTL-104A x 2, GTL-105A x 2	GPP-3323 Test Lead GTL-104A x 3
European Test Leads:	
GPP-1326 GTL-203A x 1, GTL-204A x 1, GTL-201A x 1	GPP-2323 GTL-204A x 2, GTL-201A x 1
GPP-4323 GTL-203A x 2, GTL-204A x 2, GTL-201A x 1	GPP-3323 GTL-204A x 3, GTL-201A x 1

## OPTIONAL ACCESSORIES

GTL-246 USB Cable

## OPTIONS (Manufacturer Installed Only)

LAN Interface; GPIB+LAN Interface

## GOOD WILL INSTRUMENT CO., LTD.

No.7-1, Jhongsing Road, Tucheng Dist., New Taipei City 236, Taiwan  
 T +886-2-2268-0389 F +886-2-2268-0639  
 E-mail: marketing@goodwill.com.tw



www.gwinstek.com



www.facebook.com/GWinstek

# GW INSTEK

Simply Reliable