

Precision LCR Meter

LCR-8000G Series

USER MANUAL

GW INSTEK PART NO. 82CR-81010MD1

This manual contains proprietary information, which is protected by copyright. All rights are reserved. No part of this manual may be photocopied, reproduced or translated to another language without prior written consent of Good Will company.

The information in this manual was correct at the time of printing. However, Good Will continues to improve products and reserves the right to change specification, equipment, and maintenance procedures at any time without notice.



ISO-9001 CERTIFIED MANUFACTURER

GW INSTEK

Good Will Instrument Co., Ltd.
No. 7-1, Jhongsing Rd., Tucheng City, Taipei County 236, Taiwan.

Table of Contents

SAFETY INSTRUCTION	5
GETTING STARTED	10
Main Features	12
Package Contents.....	13
Measurement Type.....	13
Model Comparison	15
Front Panel Overview	16
Rear Panel Overview	19
Tilt Stand & Power Up	21
Fixture Connection.....	24
Tutorials (Step by Step Operations)	26
Measurement tip	34
BASIC MEASUREMENT	36
Measurement Item Description	37
Measurement Mode Overview.....	47
Parameter Configuration	50
Running Measurement.....	55
PASS-FAIL MODE	58
Single-Step Test Configuration	60
Single-Step Test Run	66
Multi-Step Test Configuration	70
Multi-Step Program Run	80
Multi-Step Program File Operation	83
GRAPH MODE	87
Item Selection.....	88
Horizontal Scale Setting	90
Vertical Scale Setting	94







Speed / Step Setting	101
Running Graph Measurement	103
REMOTE CONTROL	107
Interface Configuration	108
Command Syntax	111
Command Set	112
CALIBRATION	123
FAQ	129
APPENDIX	130
Fuse Replacement	130
O/S Trimming Points	131
Z Accuracy Chart.....	134
Z vs L, C Chart	135
Accuracy Definition.....	136
Specification	137
Fixture Specifications.....	139
Declaration of Conformity.....	141
INDEX	142

S SAFETY INSTRUCTION

This chapter contains important safety instructions that you must follow when operating or storing an LCR-8000G series LCR meter. Following these instructions will ensure your safety and keep the instrument in the best possible condition.

Safety Symbols

These safety symbols may appear in this manual or on the instrument.

-  **WARNING** Warning: Identifies conditions or practices that could result in injury or loss of life.
-  **CAUTION** Caution: Identifies conditions or practices that could result in damage to the LCR-8000G or to other properties.
-  **DANGER High Voltage**
-  **Attention Refer to the Manual**
-  **Protective Conductor Terminal**
-  **Earth (ground) Terminal**



Do not dispose electronic equipment as unsorted municipal waste. Please use a separate collection facility or contact the supplier from which this instrument was purchased.

Safety Guidelines

General Guideline



- Do not place any heavy object on the instrument.
- Avoid severe impact or rough handling that leads to damaging the instrument.
- Do not discharge static electricity to the instrument.
- Do not block or obstruct the cooling fan vent opening.
- Do not perform measurement at circuits directly connected to Mains (Note below).
- Do not disassemble the instrument unless you are qualified as service personnel.

(Measurement categories) EN 61010-1:2001 specifies the measurement categories and their requirements as follows. the LCR-8000G falls under category I.

- Measurement category IV is for measurement performed at the source of low-voltage installation.
- Measurement category III is for measurement performed in the building installation.
- Measurement category II is for measurement performed on the circuits directly connected to the low voltage installation.
- Measurement category I is for measurements performed on circuits not directly connected to Mains.

Power Supply



- AC Input voltage: 115V (+10% / -25%), AC 230V (+15% / -14%) (Selectable), 50/60Hz.
- Connect the protective grounding conductor of the AC power cord to an earth ground, to avoid electrical shock.

Fuse



WARNING

- Fuse type: T3A/250V
- Make sure the correct type of fuse is installed before power up.
- To ensure fire protection, replace the fuse only with the specified type and rating.
- Disconnect the power cord before fuse replacement.
- Make sure the cause of fuse blowout is fixed before fuse replacement.

Cleaning the LCR-8000G

- Disconnect the power cord before cleaning.
- Use a soft cloth dampened in a solution of mild detergent and water. Do not spray any liquid.
- Do not use chemicals or cleaners containing harsh materials such as benzene, toluene, xylene, and acetone.

Operation Environment

- Location: Indoor, no direct sunlight, dust free, almost non-conductive pollution (Note below)
- Relative Humidity: < 80%
- Altitude: < 2000m
- Temperature: 0°C to 40°C

(Pollution Degree) EN 61010-1:2001 specifies the pollution degrees and their requirements as follows. The LCR-8000G falls under degree 2.

Pollution refers to “addition of foreign matter, solid, liquid, or gaseous (ionized gases), that may produce a reduction of dielectric strength or surface resistivity”.

- Pollution degree 1: No pollution or only dry, non-conductive pollution occurs. The pollution has no influence.
- Pollution degree 2: Normally only non-conductive pollution occurs. Occasionally, however, a temporary conductivity caused by condensation must be expected.
- Pollution degree 3: Conductive pollution occurs, or dry, non-conductive pollution occurs which becomes conductive due to condensation which is expected. In such conditions, equipment is normally protected against exposure to direct sunlight, precipitation, and full wind pressure, but neither temperature nor humidity is controlled.

Storage environment

- Location: Indoor
- Relative Humidity: < 80%
- Temperature: -40°C to 70°C

Disposal



Do not dispose this instrument as unsorted municipal waste. Please use a separate collection facility or contact the supplier from which this instrument was purchased. Please make sure discarded electrical waste is properly recycled to reduce environmental impact.

Power cord for the United Kingdom

When using an LCR-8000G series LCR meter in the United Kingdom, make sure the power cord meets the following safety instructions.

NOTE: This lead/appliance must only be wired by competent persons

! WARNING: THIS APPLIANCE MUST BE EARTHED

IMPORTANT: The wires in this lead are coloured in accordance with the following code:

- Green/ Yellow: Earth
- Blue: Neutral
- Brown: Live (Phase)



As the colours of the wires in main leads may not correspond with the coloured marking identified in your plug/appliance, proceed as follows:

The wire which is coloured Green & Yellow must be connected to the Earth terminal marked with either the letter E, the earth symbol ⊕ or coloured Green/Green & Yellow.

The wire which is coloured Blue must be connected to the terminal which is marked with the letter N or coloured Blue or Black.

The wire which is coloured Brown must be connected to the terminal marked with the letter L or P or coloured Brown or Red.

If in doubt, consult the instructions provided with the equipment or contact the supplier.

This cable/appliance should be protected by a suitably rated and approved HBC mains fuse: refer to the rating information on the equipment and/or user instructions for details. As a guide, a cable of 0.75mm² should be protected by a 3A or 5A fuse. Larger conductors would normally require 13A types, depending on the connection method used.

Any exposed wiring from a cable, plug or connection that is engaged in a live socket is extremely hazardous. If a cable or plug is deemed hazardous, turn off the mains power and remove the cable, any fuses and fuse assemblies. All hazardous wiring must be immediately destroyed and replaced in accordance to the above standard.

GETTING STARTED

This chapter describes the LCR-8000G series in a nutshell, including their main features, model comparison, front / rear panel appearance, and power up sequence. Use the Tutorial section for a quick access to the main functionalities, step by step.



Main Features	Main Features.....	12
Package contents	Package Contents	13
Measurement item	Measurement items	13
	Measurement combination.....	14
	Equivalent Circuits.....	14
Model Comparison	Major Model Differences	15
Panel overview	Front Panel Overview	16
	Rear Panel Overview.....	19
Tilt stand / Power up	Tilt stand.....	21
	Power up.....	22
	Select AC mains frequency (50/60Hz).....	23

Fixture connection	Fixture structure.....24
	Fixture connection25
Tutorial	Basic measurement (without Pass/Fail test)26
	Pass/Fail test (Single step)28
	Pass/Fail test (Multiple step).....30
	Graph mode.....32
Measurement tip	Measurement tip..... 34

Main Features

- | | |
|-------------|---|
| Performance | <ul style="list-style-type: none"> • 20Hz ~ 10MHz wide test frequency (LCR-8110G) • 6 digit measurement resolution • 10mV ~ 2V measurement drive level (DC/20Hz~3MHz) • 0.1% basic measurement accuracy |
| <hr/> | |
| Operation | <ul style="list-style-type: none"> • Spot frequency measurement • Multi-step measurement, maximum 64 programs with up to 30 steps each • Actual measurement value display • Measurement in absolute value or percentage difference from the nominal value • Pass/Fail test • Precision fixture with four-wire + ground connection • Fixture trimming, open and closed connection • Bar display mode for easy adjustment of variable components • Graph mode for visual representation of measurement data • Retains panel setup after power-Off • Large LCD display, 320x240 resolution • Intuitive user interface, comprehensive measurement functions |
| <hr/> | |
| Interface | <ul style="list-style-type: none"> • GPIB • RS-232C |

Package Contents

Ensure all the package contents are included and defect-free before using the LCR-8000G. If any of the contents in your package are missing or damaged, please contact your nearest GW Instek distributor.

<p>Standard Accessories</p>	<ul style="list-style-type: none"> • LCR 8000G model • Power Cord • LCR-12 test fixture 	<ul style="list-style-type: none"> • LCR User manual • Calibration certificate
<p>Optional Accessories</p>	<ul style="list-style-type: none"> • LCR-13 SMD/test chip fixture • LCR-09 SMD/test chip fixture • LCR-07 conventional test leads* • LCR-08 SMD clip tweezers* • LCR-06A Kelvin leads* 	<ul style="list-style-type: none"> • LCR-05 Axial/Radial component fixture* • GRA-404 rack mount (19" 4U) • GTL-232 RS232C cable, 9-pin (null modem) • GTC-001 Instrument cart <p>*Frequency: DC~1MHz</p>

Measurement Type

Measurement items

<p>Primary measurement</p>	<p>Capacitance (C)</p> <p>Reactance (X)</p> <p>Impedance (Z)</p> <p>DC Resistance (R_{DC})</p>	<p>Inductance (L)</p> <p>Susceptance (B) (=1/X)</p> <p>Admittance (Y) (=1/Z)</p>
<p>Secondary measurement</p>	<p>AC Resistance (R_{AC})</p> <p>Dissipation factor (D)</p> <p>Conductance (G)</p>	<p>Quality factor (Q)(=1/D)</p> <p>Angle (θ) (for Z and Y)</p>

Measurement combination

●:Available, —:Not available, ✕:Combination doesn't exist.

1st measurement	2nd measurement					Circuit model		Graph	*Prog
	Q	D	RAC	G	Angle	Series	Parallel		
Capacitance (C)	●	●	●	●	—	●	●	●	●
Inductance (L)	●	●	●	●	—	●	●	●	●
Reactance (X)	●	●	●	—	—	●	—	●	●
Susceptance (B)	●	●	●	●	—	—	●	●	●
Impedance (Z)	—	—	—	—	●	—	—	●	●
Admittance (Y)	—	—	—	—	●	—	—	●	●
DC Resistance(R _{DC})	—	—	—	—	—	—	—	—	●
Quality factor (Q)	✕	✕	✕	✕	✕	●	●	●	●
Dissipation factor (D)	✕	✕	✕	✕	✕	●	●	●	●
AC Resistance (R _{AC})	✕	✕	✕	✕	✕	●	●	●	●
Conductance (G)	✕	✕	✕	✕	✕	—	●	●	●
Angle (θ)	✕	✕	✕	✕	✕	—	—	●	●

*Prog: Multi-step program

Equivalent Circuits

Series or Parallel	C+R	C+D	C+Q	L+R	L+Q	L+D
Series	X+R	X+D	X+Q			
Parallel	C+G	B+G	B+D	B+Q	B+R	L+G

Model Comparison

Major Model Differences

Model	LCR-8101G	LCR-8105G	LCR-8110G
Measurement Frequency	20Hz~1MHz	20Hz~5MHz	20Hz~10MHz
Drive Signal Level	20Hz~1MHz: 0.01V~2Vrms	20Hz~≤3MHz: 0.01V~2Vrms	20Hz~≤3MHz: 0.01V~2Vrms
AC		>3MHz~5MHz: 0.01V~1Vrms	>3MHz~10MHz: 0.01V~1Vrms
DC		0.01V~2V	
Drive Signal Short Circuit Current	20Hz~1MHz: 100uA~20mA rms	20Hz~≤3MHz: 100uA~20mA rms	20Hz~≤3MHz: 100uA~20mA rms
AC		>3MHz~5MHz: 100uA~10mA rms	>3MHz~10MHz: 100uA~10mA rms
DC		100uA~20mA	
Drive Signal Accuracy (open circuit)	20Hz~1MHz: ± 2% ± 5mV	20Hz~≤1MHz: ± 2% ± 5mV	20Hz~≤1MHz: ± 2% ± 5mV
AC		>1MHz~5MHz: ± 5% ± 10mV	>1MHz~10MHz: ± 5% ± 10mV
DC		± 2% ± 5mV	

Front Panel Overview

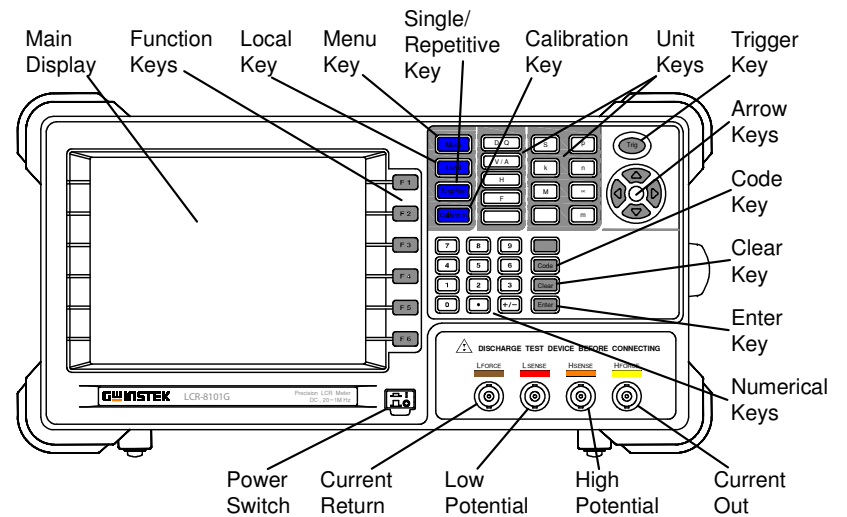

Main display 320 by 240, DST LCD display.











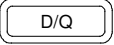
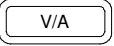
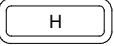
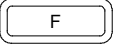
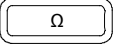

Function keys **F 1** ~ **F 6** Assigned to the menu on the right side of the display.

Local key **Local** When the instrument is under remote control mode, sets the instrument back into local panel operation. For remote control details, see page107.

Menu key **Menu** Shows the main menu on the display.

Single/Repetitive key **Sing/Rep** Selects Single measurement mode (manual triggering) or Repetitive measurement mode (automatic triggering). See page55 for details.

- Calibration key  Enters the calibration mode. See page123 for calibration details.
- Unit keys Enters unit when editing values.

 -  Dissipation factor or Quality factor
 -  Voltage or Ampere
 -  Henry (for Inductance)
 -  Farad (for Capacitance)
 -  Ohm (for Resistance, Impedance)
 -  Siemens (for Susceptance, Admittance)
 -  Kilo (10³)  Mega (10⁶)
 -  Pico (10⁻¹²)  Nano (10⁻⁹)
 -  Micro (10⁻⁶)  Milli (10⁻³)
- Trigger key  Manually triggers measurement. Available only in Single measurement mode (page55).
- Arrow keys  Selects menu items or parameters. The Up/Down and Left/Right keys are used in pairs.
- Code key  Enters system codes for changing drive Voltage/Current display (page57) or frequency adjustment resolution (page53).
- Clear key  Clears all previous entries when editing values.

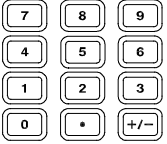
- Enter key  Confirms the entered value or selection.
- Numerical keys  Enters numeric values.
- Measurement terminals Accepts measurement fixture. For connection details, see page24.

 - LFORCE Current return
 - LSENSE Low potential
 - HSENSE High potential
 - HFORCE Current output

LFORCE

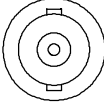



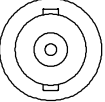

LSENSE

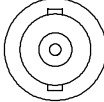

HSENSE

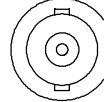

HFORCE

- Power switch  Turns On  or Off  the main power. For power up sequence, see page22.

Rear Panel Overview

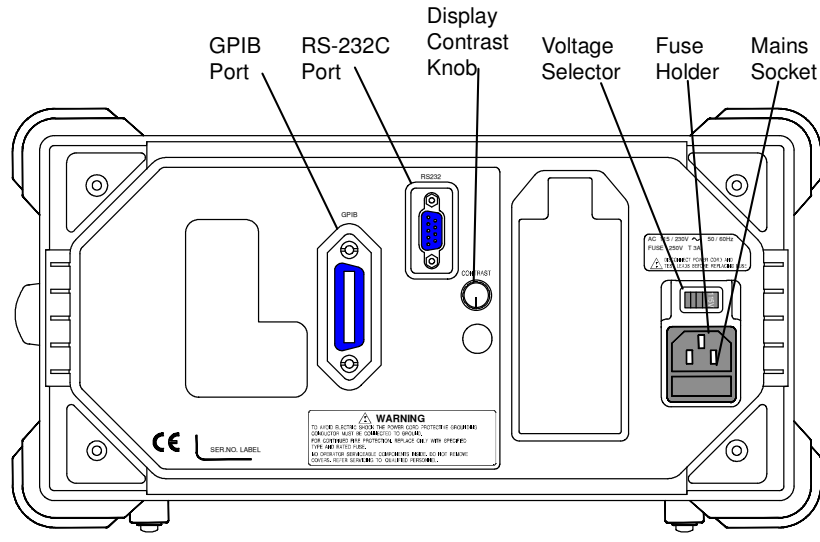

GPIB port / RS-232C port

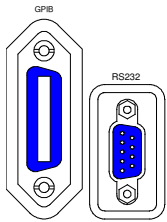

Accepts remote control cables.

GPIB: 24-pin female

RS-232C: DB-9 pin male

See page107 for remote control details.

Display contrast knob



Sets the display contrast level. See page22 for details.

Voltage selector / Fuse holder / Mains socket

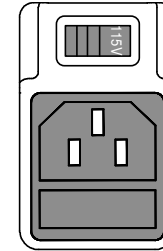

The voltage selector sets the AC mains voltage:
AC 115V (+10% / -25%), AC 230V (+15% / -14%) (Selectable), 50/60Hz.

The fuse holder contains the main fuse, T3A/250V. For fuse replacement details, see page130.

The mains socket accepts power cable. See page22 for power-up details.

Tilt Stand & Power Up

Tilt stand

Low angle

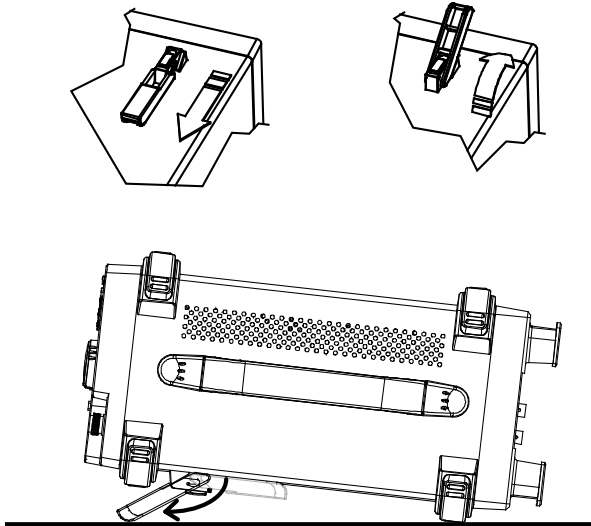

High angle

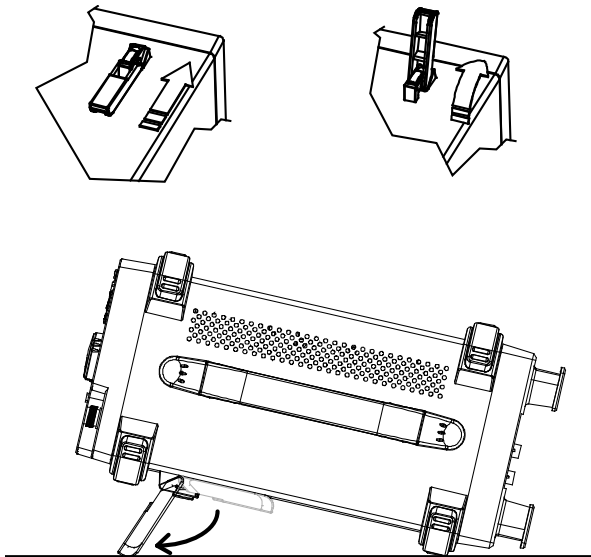

Power up

Panel operation



1. Set the rear panel Voltage selector to the correct position according to the AC mains voltage.

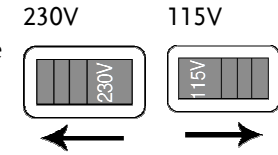

2. Connect the power cord to the socket.

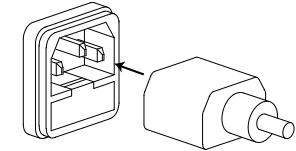

3. Turn On the power switch. The display becomes active in 2~3 seconds.

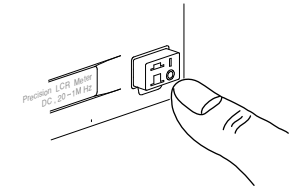

4. Use the contrast knob on the rear panel to adjust the LCD display brightness.

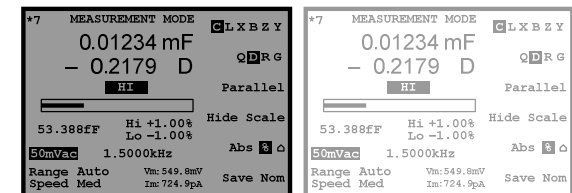
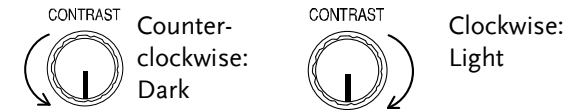

Select AC mains frequency (50/60Hz)

Background Although the LCR-8000G works under both 50 and 60Hz power frequencies, we recommend selecting the frequency that matches the local setting to get the best measurement precision, especially at lower frequencies (< 100Hz).

Panel operation 1. Press the Menu key, then F5 (System). The system menu appears.

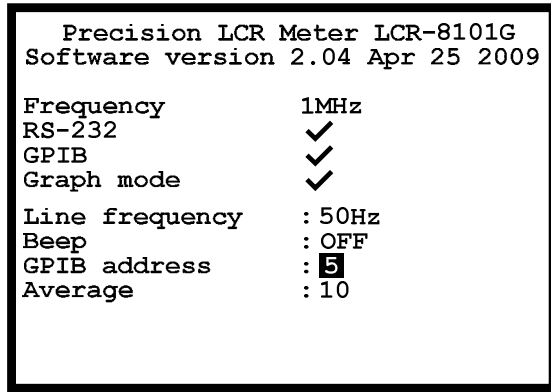

2. Press the Up/Down key and move the cursor to Line frequency. **Line frequency : 50Hz**

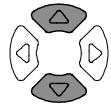

3. If necessary, press the Left/Right key to select the frequency, from 50 to 60Hz or from 60Hz to 50Hz. **Line frequency : 60Hz**

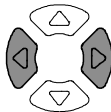

Fixture Connection

Fixture structure

Background The standard fixture is a four-wire type with a common terminal for screen connection. The outer terminals (Hforce and Lforce) provide the current and the inner terminals (Hsense and Lsense) measures the potential.

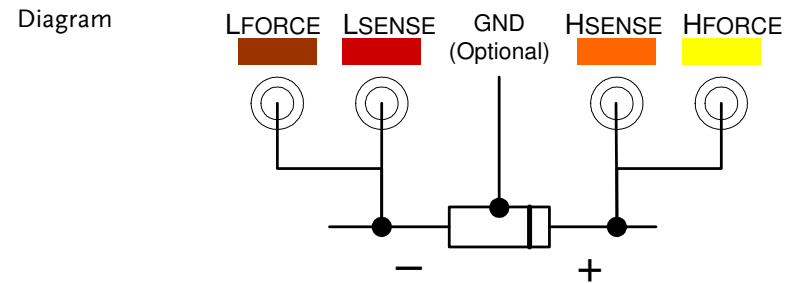

Description	HFORCE	Carries the signal current source. Connected to the + side of the device under test.
	HSENSE	Together with Lsense, monitors the Potential. Connected to the + side of the device under test.
	LSENSE	Together with Hsense, monitors the Potential. Connected to the - side of the device under test.
	LFORCE	Accepts the signal current return. Connected to the - side of the device under test.
	GND	If the test component has a large metal area NOT connected to either of the terminals, connect the GND clip to minimize noise level.

Fixture connection

- Panel operation
1. Discharge the test component before connecting the fixture set.
 2. Connect each fixture terminal to the front panel BNC connector with matching color.

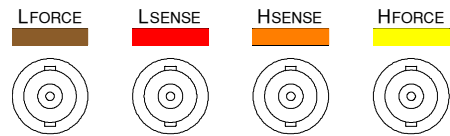

3. Connect the fixture to the test component. If the component has polarity, connect the H side to the positive lead and the L side to the negative lead. Make sure the distance between the lead base and fixture clip is short enough.

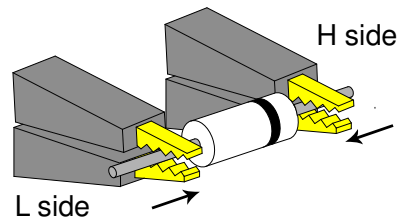

4. If the test component has an outer case unconnected to either of the leads, connect the ground terminal for noise level reduction.

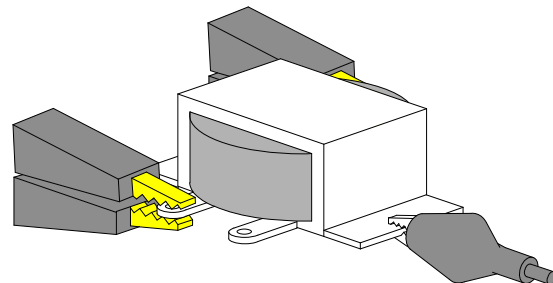

Tutorials (Step by Step Operations)

Basic measurement (without Pass/Fail test)

Step	Description	Details
1. Connect fixture	Connect the fixture to the DUT.	Page24
2. Enter menu	Press the Menu key, followed by F1 (AC measurement) or F2 (Rdc).	Page47
3. Hide scale	Press F4 (Show/Hide Scale) to hide the scale (or show the circuit diagram)	Page49
4. Select measurement item	Press F1 (First) and F2 (Second) repeatedly to select the measurement item.	Page50
5. Select series/parallel circuit	If available, press F3 (Series/Parallel) to select the equivalent circuit model.	Page50
6. Set measurement frequency	Press the Left/Right arrow key and move the cursor to the Frequency. Use the numerical and unit keys to set the frequency.	Page52
7. Set measurement Voltage	Press the Left/Right arrow key and move the cursor to the Voltage. Use the numerical and unit keys to set the level.	Page54
8a. Select Single measurement	Press the Sing/Rep key to select Single (manual trigger) measurement. To trigger measurement, press the Trig key.	Page55
8b. Select Repetitive measurement	Press the Sing/Rep key to select Repetitive (automatic trigger) measurement. Press the Left/Right arrow key and move the cursor to Speed. Press the Up/Down key to select the speed.	Page56

- Optional settings To hide the drive Voltage/Current, press the Code key, type 80, then press Enter. Page57
- Set the Range (internal setting) to Auto, use the Left/Right key to move the cursor and Up/Down key to change the setting. Page51

Pass/Fail test (Single step)

Step	Description	Details
1. Connect fixture	Connect the fixture to the DUT.	Page24
2. Set buzzer sound	Press the Menu key, then F5 (System). Press the Up/Down arrow key to move the cursor to Beep, then use the Left/Right key to select setting (Off recommended).	Page61
3. Set Average	Press the Menu key, then F5 (System). Press the Up/Down arrow key to move the cursor to Average, then use the numerical keys to enter an average number (1-256). Press enter to confirm the number.	Page62
4. Enter menu	Press the Menu key, followed by F1 (AC measurement) or F2 (Rdc).	Page47
5. Show scale	Press F4 (Show/Hide Scale) to show the scale (or hide the circuit diagram)	Page 49
6. Select measurement item	Press F1 (First) and F2 (Second) repeatedly to select the measurement item.	Page50
7. Select series/parallel circuit	If available, press F3 (Series/Parallel) to select the equivalent circuit model.	Page50
8. Set measurement frequency	Press the Left/Right arrow key and move the cursor to the Frequency. Use the numerical and unit keys to set the frequency.	Page52
9. Set measurement Voltage	Press the Left/Right arrow key and move the cursor to the Voltage. Use the numerical and unit keys to set the level.	Page54
10a. Select Single measurement	Press the Sing/Rep key to select Single (manual trigger) measurement. To trigger measurement, press the Trig key.	Page55

10b. Select Repetitive measurement	Press the Sing/Rep key to select Repetitive (automatic trigger) measurement. Press the Left/Right arrow key and move the cursor to Speed. Press the Up/Down key to select the speed.	Page56
11a. Select Absolute measurement	Press F5 (Abs/%/Δ) to select Abs. Press the Left/Right key to move the cursor to Lo (Low limit). Use the numerical and unit keys to set the Low limit. Repeat this for Hi (Hi limit) as well.	Page66
11b. Select Percentage measurement	Press F5 (Abs/%/Δ) to select %. Press the Left/Right key to move the cursor to the Nominal value. Use the numerical and unit keys to set the numerical level. Then move the cursor to Lo (Low limit) and set the percentage. Repeat this for Hi (Hi limit) as well. To save the latest measurement result as Nominal, press F6 (Save Nom).	Page67
11c. Select Delta measurement	Press F5 (Abs/%/Δ) to select Δ. Press the Left/Right key to move the cursor to the Nominal value. Use the numerical and unit keys to set the numerical level. Then move the cursor to Lo (Low limit) and set the Lo value difference. Repeat this for Hi (Hi limit) as well. To save the latest measurement result as Nominal, press F6 (Save Nom).	Page68
Optional settings	To hide the drive Voltage/Current, press the Code key, type 80, then press Enter. Set the Range (internal setting) to Auto, use the Left/Right key to move the cursor and Up/Down key to change the setting.	Page57 Page51

Pass/Fail test (Multiple step)

Step	Description	Details
1. Connect fixture	Connect the fixture to the DUT.	Page24
2. Set buzzer sound	Press the Menu key, then F5 (System). Press the Up/Down arrow key to move the cursor to Beep, then use the Left/Right key to select setting (Off recommended).	Page72
3. Set Average	Press the Menu key, then F5 (System). Press the Up/Down arrow key to move the cursor to Average, then use the numerical keys to enter an average number (1-256). Press enter to confirm the number.	Page73
4. Enter multiple step mode	Press the Menu key, then F3 (Multi step).	Page74
5. Select measurement item	Press the arrow keys to move the cursor to Step 01 Func. Press F1 (Prog) repeatedly to select the item.	Page76
6a. Set parameters	Press the arrow keys to move the cursor to the parameters below. Use the numerical and unit keys for editing values or F1 (Prog) for selecting options.	Page76
6b. Add steps	Move the cursor to the first empty step and press F1 (Prog).	Page76
6c. Copy to the next step	Press F2 (Copy). The selected step contents are copied and inserted to the next step.	Page79
6d. Delete step	Press F3 (Delete). The selected step is deleted.	Page79
7. Save program	Press F4 (Save). The edited program is saved.	Page83

8. Enter Run menu	Press F6 (Run). The Run menu opens.	Page80
9. Set Single or Repetitive	Press the Sing/Rep key to select Single (manual trigger) or Repetitive (auto trigger).	Page80
10. Start running	If the test has not started yet, press F1 (Start) or Trig key. Press F6 (Set) to go back to the setup menu.	Page80
File operation: new program	Press F5 (File), then F4 (New). Press the Left/Right keys to move the cursor and press the Down key to select character. To confirm the file name, press the Enter key. A new file appears. To delete a character, press the Up key. To quit, press the Clear key.	Page74
File operation: load	Press F5 (File), then F1 (Load). Use the arrow keys to select the program and press F1 (Load).	Page85
File operation: delete	Press F5 (File), then F2 (Delete). Use the arrow keys to select the program and press F5 (Del).	Page86
File operation: save as	Press F5 (File), then F3 (Save as). Press the Left/Right keys to move the cursor and press the Down key to select character. To confirm the file name, press the Enter key. A new file appears. To delete a character, press the Up key. To quit, press the Clear key.	Page83

Graph mode

Step	Description	Details
1. Connect fixture	Connect the fixture to the DUT.	Page24
2. Enter graph mode	Press the Menu key, then F4 (Graph).	Page88
3. Select item	Press F5 repeatedly to select the graph item.	Page89
4a. Set horizontal scale (frequency)	Press the Up/Down key to move the cursor to Sweep. Press the Left/Right key to select Frequency. Then move the cursor to Start Frequency, set the value using the numerical and unit keys. Repeat this for Stop Frequency and Level (drive Voltage).	Page92
4b. Set horizontal scale (voltage)	Press the Up/Down key to move the cursor to Sweep. Press the Left/Right key to select Voltage. Then move the cursor to Start Voltage, set the value using the numerical and unit keys. Repeat this for Stop Voltage and Freq (frequency).	Page90
5. Select speed	Press the Up/Down key to move the cursor to Speed. Press the Left/Right key to select the measurement speed.	Page101
6. Select step size	Press the Up/Down key to move the cursor to Step size. Press the Left/Right key to select the data step (all or sampled).	Page102
7. Select linear or log scale	Press F1 (Lin/Log) to select linear or logarithmic horizontal scale.	Page91
8a. Set vertical scale (Absolute + Auto fit)	Press F2 (Abs/ %) to select Abs, then press F3 (Manual/ Auto fit) to select Auto fit. the LCR-8000G automatically configures the vertical scale.	Page98

- 8b. Set vertical scale (Absolute + Manual fit) Press F2 (Abs/%) to select Abs, then press F3 (Manual/ Auto fit) to select Manual fit. Move the cursor to Hi, set the Hi value. Repeat this for Lo as well. The minimum and maximum vertical range is manually configured. Page94

- 8c. Set vertical scale (Percentage + Auto fit) Press F2 (Abs/%) to select %, then press F3 (Manual/ Auto fit) to select Auto fit. Move the cursor to Nominal and set the nominal value. The LCR-8000G automatically configures the vertical range around the nominal value. Page99

- 8d. Set vertical scale (Percentage + Manual fit) Press F2 (Abs/%) to select %, then press F3 (Manual/ Auto fit) to select Manual fit. Move the cursor to Hi, set the Hi percentage. Repeat this for Lo and Nominal. The minimum and maximum vertical range is manually configured. Page96

- 9. Plot graph Press F4 (Start). The graph is drawn on the display. To abort, press F6 (Abort). Page103

- 10. Fit graph into display When plotting is finished, press F1 (Function), then F2 (Fit). The vertical scale is automatically adjusted to include all the plotted line. Press F1 (View) to go back. Page105

- 11. Move marker Press the Left/Right keys to move the marker on the graph. To move the marker to the peak, press F1 (Function) and F3 (Peak). To move to the dip, press F4 (Dip). Press F1 (View) to go back. Page106

- 12. Return to previous menu Press F6 (Return) or press the Menu key to go back to the previous or the other menu. Page106

Measurement tip

- Hi/Low impedance If the measured impedance is greater than 1kΩ, the standard four-terminal connection is not necessary. Run S/C trim to remove the effect of series lead impedance.

If the measured impedance is lower than 1kΩ, four-terminal connection can reduce the effect of contact resistance at the test component.

- Metal component case connection A large area of metal can add noise to the measurement. Here is how to minimize the effect.

If the metal is connected to one of the terminals, this should be connected to the Hforce (Yellow) terminal side.

If the metal is NOT connected to either of the terminals, connect the GND clip.

- Small-sized capacitor When measuring small, SMD-size capacitors, run O/C trim at the measurement frequency (Spot trimming) to eliminate the residual capacitance. Make sure the measurement lead positions are fixed during trimming.

- Small-sized inductor When measuring small, SMD-size inductors, run S/C trim at the measurement frequency (Spot trimming). The LCR-8000G measures the difference between the inductance of S/C trimming and the inductance of test component. Four-terminal fixture set is recommended and make sure the measurement leads are fixed during trimming.

Wire capacitance	When measuring the wire capacitance, the fixture clips that are marked with H _F (High Force)/H _S (High Sense) should always be connected to the point that is influenced the most by noise.
Wire inductance	The wire inductance should be subtracted from the measurement result. <ul style="list-style-type: none"> • 5cm, 1mm diameter wire has 50nH inductance • 5cm, 2mm diameter wire has 40nH inductance
Frequency factor in inductor measurement	When an inductor is measured at a frequency much lower than that for which it is designed (for example, an HF choke tested at AF), the inductor tends to behave as an inductive resistor. In these circumstances, measurement accuracy is widened by $(1 + 1/Q)$ where Q is the quality factor.
Air-cored coils	Air-cored coils can pick up noise very easily, therefore they should be kept well clear of any test equipment that may contain power transformers or display scan circuitry. Also, keep the coils away from metal objects which may modify inductor characteristics.
Iron-cored and ferrite inductor	The effective value of iron-cored and ferrite inductors can vary widely with the magnetization and test signal level. Measure them at the AC level and frequency in use. When core materials are damaged by excessive magnetization (for example: tape heads and microphone transformers), check that the test signal is acceptable before connection.

BASIC MEASUREMENT

Basic measurement measures DUT in numerical style. Advanced measurements are available in Pass/Fail test mode (page58), where measurement results are compared with user-defined limits, and in Graph mode (page87), where measurement data is displayed in graphical representation.

Measurement item	Measurement combination..... 37
	Series/Parallel circuit models..... 38
	Resistance (R) and Conductance ($G = 1/R$) 40
	Capacitance (C) 41
	Inductance (L)..... 42
	Reactance (X) and Susceptance ($B = 1/X$)..... 43
	Impedance (Z) and Admittance ($Y = 1/Z$)..... 44
	Quality factor (Q) and Dissipation factor (D) 45
	Angle (θ) 46
Measurement overview	Enter measurement mode..... 47
	Display overview 48
	Show circuit model or scale (pass/fail) 49
Measurement configuration	Select measurement item..... 50
	Set measurement range to Auto 51
	Set measurement frequency..... 52
	Set measurement voltage..... 54
Run measurement	Select Single measurement..... 55
	Select Repetitive measurement..... 56
	Hide drive Voltage/Current 57

Measurement Item Description

In general, two items, primary and secondary, are combined in a single measurement. The following table shows the available combinations. Overview of each measurement item is listed from the next page.

Measurement combination

●:Available, —:Not available, ✕:Combination doesn't exist.

1st measurement	2nd measurement					Circuit model		Graph	*Prog
	Q	D	R _{AC}	G	Angle	Series	Parallel		
Capacitance (C)	●	●	●	●	—	●	●	●	●
Inductance (L)	●	●	●	●	—	●	●	●	●
Reactance (X)	●	●	●	—	—	●	—	●	●
Susceptance (B)	●	●	●	●	—	—	●	●	●
Impedance (Z)	—	—	—	—	●	—	—	●	●
Admittance (Y)	—	—	—	—	●	—	—	●	●
DC Resistance(R _{DC})	—	—	—	—	—	—	—	—	●
Quality factor (Q)	✕	✕	✕	✕	✕	●	●	●	●
Dissipation factor (D)	✕	✕	✕	✕	✕	●	●	●	●
AC Resistance (R _{AC})	✕	✕	✕	✕	✕	●	●	●	●
Conductance (G)	✕	✕	✕	✕	✕	—	●	●	●
Angle (θ)	✕	✕	✕	✕	✕	—	—	●	●

*Prog: Multi-step program

- The graph measurement is described in the Graph Mode chapter, page87.
- The multi-step program mode is described in the Pass/Fail test chapter, page70.

Series/Parallel circuit models

Background For measuring AC Resistance, Capacitance, Reactance, Inductance, and Susceptance, series and parallel equivalent circuit models are available. Select the model according to the component value.

Capacitance (C)

Series diagram

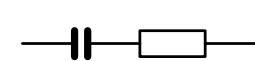

Parallel diagram

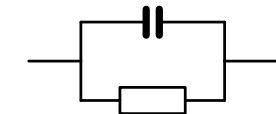

Series formula

$$C_S = C_P(1 + D^2)$$

D=dissipation factor

Parallel formula

$$C_P = \frac{C_S}{(1 + D^2)}$$

D=dissipation factor

When to use Series (C_S)

Small capacitance:
Reactance (X_C) < 1kΩ

$$\text{Note: } X_C = \frac{1}{2\pi f C}$$

When to use Parallel (C_P)

Large capacitance:
Reactance (X_C) > 1kΩ

$$\text{Note: } X_C = \frac{1}{2\pi f C}$$

Inductance (L)

Series diagram



Parallel diagram

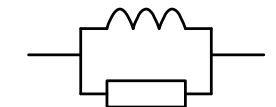

Series formula

$$L_S = \frac{L_P}{\left(1 + \frac{1}{Q^2}\right)}$$

Q=quality factor

When to use Series (L_S)

Small inductance:
Reactance (X_L) < 1kΩ

Note: $X_L = 2\pi fL$

Parallel formula

$$L_P = L_S \left(1 + \frac{1}{Q^2}\right)$$

Q=quality factor

When to use Parallel (L_P)

Large inductance:
Reactance (X_L) > 1kΩ

Note: $X_L = 2\pi fL$

Resistance

Series diagram

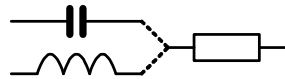

Series formula

$$R_S = \frac{R_P}{\left(1 + Q^2\right)}$$

Q=quality factor

When to use Series (R_S)

Small resistance: < 1kΩ

Parallel diagram

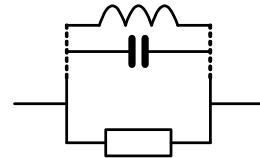

Parallel formula

$$R_P = R_S \left(1 + Q^2\right)$$

Q=quality factor

When to use Parallel (R_P)

Large resistance: > 1kΩ

Resistance (R) and Conductance (G = 1/R)

Background

Resistance measures how difficult it is for the electricity to flow between two terminals. Conductance is the reciprocal of Resistance and measures how easily the electricity flows.

Resistance

Conductance

Type

- Series Resistance R_S
 - Parallel Resistance R_P
 - DC Resistance R_{dc}
 - Parallel Conductance G_P (= 1/R_P)
- Note: Conductance is available only for parallel circuit models.

Display Range

0.01mΩ ~ 1GΩ

0.001ns ~ 1ks

Measurement combination

- C_S + R_S
- L_S + R_S
- X_S + R_S
- C_P + R_P
- L_P + R_P
- B_P + R_P
- R_{dc}
- C_P + G_P
- B_P + G_P
- L_P + G_P

Formula

$$R = \frac{V}{I} = \frac{1}{G} = Z_S - jX \quad G_P = \frac{I}{V} = \frac{1}{R} = Y_P - jB$$

$$= Z_S - j\omega L = Z_S + \frac{j}{\omega C} = Y_P - j\omega C = Y_P + \frac{j}{\omega L}$$

$$|Z_S| = \sqrt{(R^2 + X^2)} \quad |Y_S| = \frac{GB}{\sqrt{(G^2 + B^2)}}$$

$$|Z_P| = \frac{RX}{\sqrt{(R^2 + X^2)}} \quad |Y_P| = \sqrt{(G^2 + B^2)}$$

$$R_S = |Z| \cos \theta \quad G_P = |Y| \cos \theta$$

Capacitance (C)

Background	Capacitance measures the amount of electronic charge stored between two terminals.	
Display Range	0.001pF ~ 1F	
Type	<ul style="list-style-type: none"> • Series Capacitance C_S • Parallel Capacitance C_P 	
Combination	<ul style="list-style-type: none"> • $C_S + Q$ • $C_S + D$ • $C_S + R_S$ 	<ul style="list-style-type: none"> • $C_P + Q$ • $C_P + D$ • $C_P + R_P$ • $C_P + G_P$
Formula	$Z_S = R - \frac{j}{\omega C}$ $Q = \frac{1}{\omega C_S R_S}$ $D = \omega C_S R_S$	$Y_P = G + j\omega C$ $Q = \omega C_P R_P \quad D = \frac{G_P}{\omega C_P}$

Inductance (L)

Background	Inductance measures the amount of magnetic flux generated in certain electrical current.	
Display Range	0.1nH ~ 100kH	
Type	<ul style="list-style-type: none"> • Series Inductance L_S • Parallel Inductance L_P 	
Measurement combination	<ul style="list-style-type: none"> • $L_S + Q$ • $L_S + D$ • $L_S + R_S$ 	<ul style="list-style-type: none"> • $L_P + Q$ • $L_P + D$ • $L_P + R_P$ • $L_P + G_P$
Formula	$Z_S = R + j\omega L$ $Q = \frac{\omega L_S}{R_S}, \quad D = \frac{R_S}{\omega L_S}$	$Y_P = G - \frac{j}{\omega L}$ $Q = \frac{R_P}{\omega L_P}, \quad D = \omega L_P G_P$

Reactance (X) and Susceptance (B = 1/X)

Background	Reactance measures the imaginary part of Impedance (Z) caused by capacitors or inductors. Susceptance is the reciprocal of Reactance and measures the imaginary part of Admittance (Y), which is also the reciprocal of Impedance.	
Type	Series Reactance (X _S) Note: Reactance is available only in series circuit model.	Parallel Susceptance (B _P) Note: Susceptance is available only in parallel circuit model.
Display Range	0.01mΩ ~ 1GΩ	0.001ns ~ 1ks
Measurement combination	<ul style="list-style-type: none"> • X_S + Q • X_S + D • X_S + R_S 	<ul style="list-style-type: none"> • B_P + Q • B_P + D • B_P + R_P • B_P + G_P
Formula	$X = \frac{1}{B} = Z \sin \theta$ $ Z_S = \sqrt{(R^2 + X^2)}$ $ Z_P = \frac{RX}{\sqrt{(R^2 + X^2)}}$ $X_S = Z \sin \theta$	$B = \frac{1}{X} = Y \sin \theta$ $ Y_S = \frac{GB}{\sqrt{(G^2 + B^2)}}$ $ Y_P = \sqrt{(G^2 + B^2)}$ $B_P = Y \sin \theta$

Impedance (Z) and Admittance (Y = 1/Z)

Background	Impedance measures the total amount of opposition between two terminals in an AC circuit. Admittance is the reciprocal of Impedance and measures how easily the electricity flows in an AC circuit.	
Type	Impedance (Z)	Admittance (Y)
Display Range	0.01mΩ ~ 1GΩ	0.001ns ~ 1ks
Formula	$Z = \frac{E}{I} = \frac{1}{Y}$ $Z_S = R + jX$ $= R + j\omega L = R - \frac{j}{\omega C}$ $ Z_S = \sqrt{(R^2 + X^2)}$ $ Z_P = \frac{RX}{\sqrt{(R^2 + X^2)}}$ $R_S = Z \cos \theta$ $X_S = Z \sin \theta$	$Y = \frac{I}{E} = \frac{1}{Z}$ $Y_P = G + jB$ $= G + j\omega C = G - \frac{j}{\omega L}$ $ Y_S = \frac{GB}{\sqrt{(G^2 + B^2)}}$ $ Y_P = \sqrt{(G^2 + B^2)}$ $G_P = Y \cos \theta$ $B_P = Y \sin \theta$

Quality factor (Q) and Dissipation factor (D)

Background Both Quality factor and its reciprocal, Dissipation factor, are used for measuring the rate of energy dissipation relative to the measurement frequency.

- Low energy dissipation: high Q, low D
- High energy dissipation: low Q, high D

Type Quality factor (Q) Dissipation factor (D)

Display Range 0.01 ~ 9999.9 0.00001 ~ 1000

Formula

$$Q = \frac{\omega L_S}{R_S} = \frac{1}{\omega C_S R_S}$$

$$D = \frac{R_S}{\omega L_S} = \omega C_S R_S$$

$$= \frac{R_P}{\omega L_P} = \omega C_P R_P$$

$$= \frac{G_P}{\omega C_P} = \omega L_P G_P$$

$$= \frac{1}{\tan(90 - \theta)^\circ} = \frac{1}{D}$$

$$= \tan(90 - \theta)^\circ = \frac{1}{Q}$$

Angle (θ)

Background The Angle (θ) measures the phase on which Impedance (Z), Admittance (Y), Quality factor (Q), and Dissipation factor (D) are measured.

Type Angle (θ)

Display Range -180° ~ +180°

Formula

$$Z_S = R + jX$$

$$= R + j\omega L = R - \frac{j}{\omega C}$$

$$Q = \frac{1}{\tan(90 - \theta)^\circ} = \frac{1}{D}$$

$$R_S = |Z| \cos \theta$$

$$X_S = |Z| \sin \theta$$

$$Y_P = G + jB$$

$$= G + j\omega C = G - \frac{j}{\omega L}$$

$$D = \tan(90 - \theta)^\circ = \frac{1}{Q}$$

$$G_P = |Y| \cos \theta$$

$$B_P = |Y| \sin \theta$$



Measurement Mode Overview

Enter measurement mode

Type	AC	C, L, X, B, Z, Y, Q, D, R, G, θ
	DC	Rdc

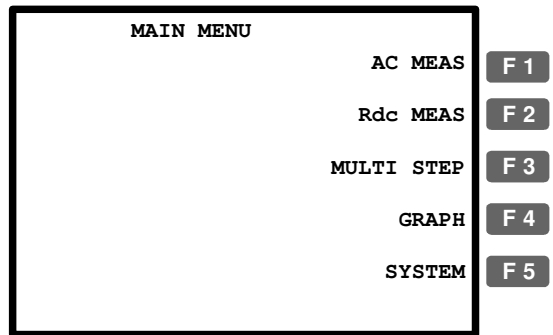
Panel operation 1. Press the Menu key. The main menu appears. 



2. For Rdc measurement, press F2 (Rdc Meas). 
 For any other measurement, press F1 (AC Meas). The measurement mode display appears. 

AC measurement

DC measurement (Rdc)

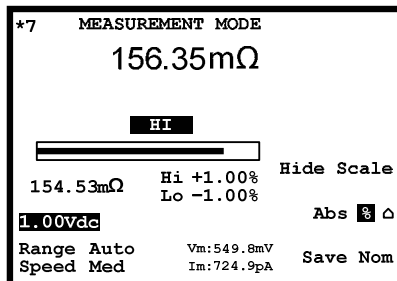
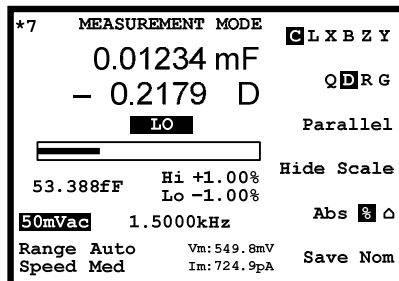

Display overview

Normal mode

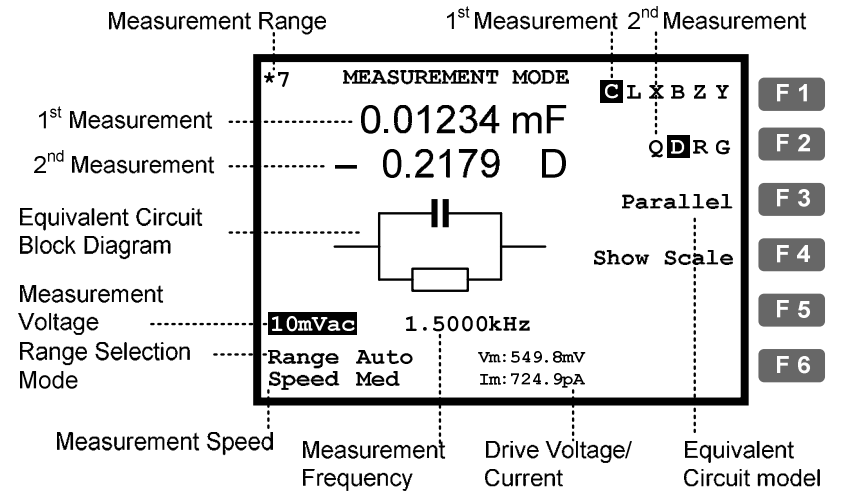

Absolute mode (Pass/Fail test)

Percentage mode (Pass/Fail test)

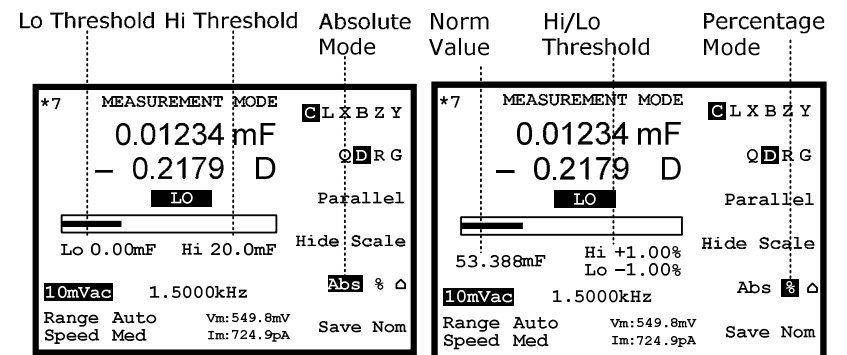

Delta mode (Pass/Fail test)

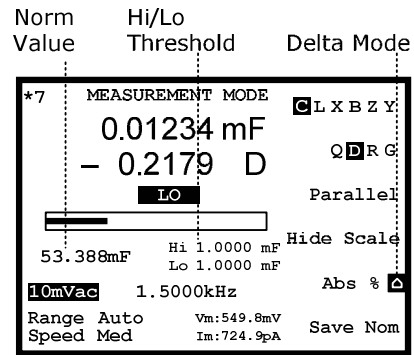

For Pass/Fail test details, see page58.

Show circuit model or scale (pass/fail)

Background The center of the display can be filled with the diagram of equivalent circuit model, or the measurement scale with Pass/Fail test result. This selects not only the diagram/scale but also whether running the Pass/Fail test or just measuring the value.

Panel operation Press F4 (Show/Hide scale) to view the circuit model or scale. **F 4**

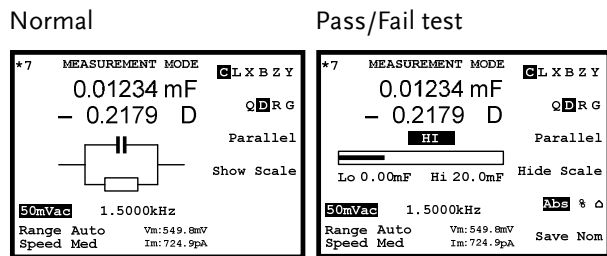

Pass/Fail test For Pass/Fail test details, see page58.

Parameter Configuration

Select measurement item

*This is not necessary for Rdc measurement.

Measurement combination	The following list shows the available combination of the first and second measurement items.
Capacitance (C)	Series C-Q, C-D, C-R
	Parallel C-Q, C-D, C-R, C-G
Inductance (L)	Series L-Q, L-D, L-R
	Parallel L-Q, L-D, L-R, L-G
Reactance (X)	Series X-Q, X-D, X-R
Susceptance (B)	Parallel B-Q, B-D, B-R, B-G
Impedance (Z)	Z-Angle
Admittance (Y)	Y-Angle

Panel operation To select the first measurement item, press F1 repeatedly. **F 1**

C L X B Z Y

To select the second measurement item, press F2 repeatedly. **F 2**

Q D R G

To select the circuit model, series or parallel, press F3 repeatedly. **F 3**

Series

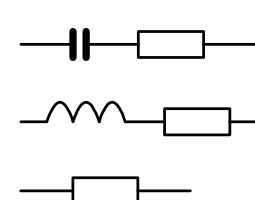

Parallel

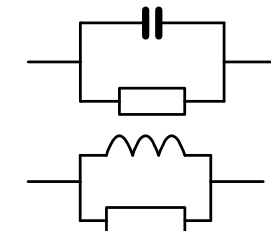

Set measurement range to Auto

Background The measurement range is an internal parameter defining the search range for each measurement item. Make sure the Auto setting is always selected, to obtain the best measurement accuracy. The active range appears at the top left corner of the display.

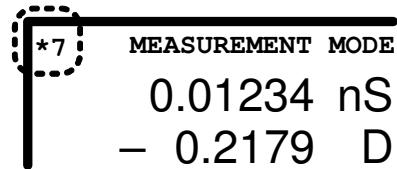

Panel operation 1. Press the Left/Right key repeatedly to move the cursor to Range position.

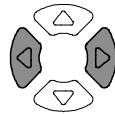

Range Auto
Speed Slow

2. If the range is NOT set to Auto, press the Up/Down key repeatedly to set it back to Auto.

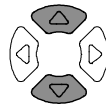

Range 5 → **Range Auto**
Speed Slow → **Speed Slow**

Set measurement frequency

*This setting does not apply to Rdc measurement.

Background The measurement frequency, together with the measurement voltage, defines the electrical condition of each measurement item. Make sure the appropriate frequency is selected, according to the component characteristics.

Panel operation 1. Press the Left/Right key repeatedly to move the cursor to Frequency.

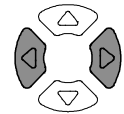

2.00 Vac **195.00 kHz**

2. Enter the frequency using the numerical keys.

Range 20Hz ~ 1MHz (LCR-8101G)
 20Hz ~ 5MHz (LCR-8105G)
 20Hz ~ 10MHz (LCR-8110G)

1.2kHz [1] [.] [2] [k] [Enter]

1MHz [1] [M] [Enter]

Backspace All clear [Clear]

Increase Decrease

When the entered value does not fit in the range, the LCR-8000G automatically selects the nearest value.

Nearest Available

When the wrong unit (such as Ω) is entered, the value is cancelled.

Unit Mismatched

Select frequency step resolution For frequency increase/decrease using Up/Down keys, fine and coarse step settings are available.

Fine 1st digit: 1, 2, 3, 4, 5, 6...

Coarse 2nd digit: 10, 12, 15, 20, 25, 30, 40, 50, 60, 80

1. Press the Code key.



2. Enter the system code using the numerical keys, then press the Enter key. A confirmation message appears on the display.

Fine: 10

Freq fine steps

Coarse: 11

Freq coarse steps

Set measurement voltage

Background The measurement voltage, together with the measurement frequency, defines the electrical condition of each measurement item. Make sure the appropriate voltage is selected, according to the component characteristics.

Voltage setting 1. Press the Left/Right key repeatedly to move the cursor to Voltage.

2.00 Vac **195.00 kHz**

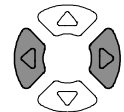

2. Enter the voltage using the numerical keys.

Range DCV:10mV ~ 2V
AC, 20Hz~≤ 3MHz: 0.01V~2Vrms
AC, >3MHz~10MHz: 0.01V~1Vrms

100mV

1V

Backspace All clear

Increase Decrease

When the entered value does not fit in the range, the LCR-8000G automatically selects the nearest value.

Nearest Available

When the wrong unit (such as Ω) is entered, the value is cancelled.

Unit Mismatched

Running Measurement

Select Single measurement

Background The data capture can be manually controlled (Single) or automatically updated (Repetitive).
 In single measurement, the measurement is activated by pressing the Trigger key.
 In repetitive measurement, the measurement is automatically done and the display is updated according to the speed (timing) setting.

- Panel operation**
1. Press the Sing/Rep key repeatedly until the "Single Shot Mode" message appears on the display.



Single Shot Mode

2. The measurement update indicator (*) does not appear at the top left corner of the display.

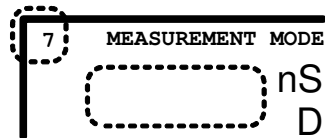

3. To capture measurement data, press the Trigger key. The measurement update indicator (*) blinks and the measurement result is updated on the display.

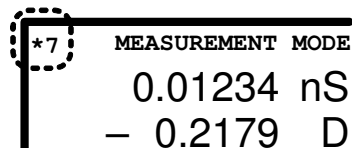

Select Repetitive measurement

Background The data capture can be manually controlled (Single) or automatically updated (Repetitive).
 In single measurement, the measurement is activated by pressing the Trigger key.
 In repetitive measurement, the measurement is automatically done and the display is updated according to the speed (timing) setting.

- Panel operation**
1. Press the Sing/Rep key repeatedly until the "Repetitive Mode" message appears on the display.



Repetitive Mode

2. The measurement update indicator (*) keeps blinking and the measurement result is updated on the display.

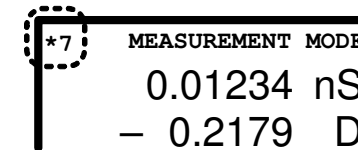

3. Press the Left/Right key repeatedly to move the cursor to measurement speed.

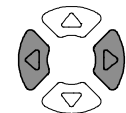

Speed Slow

4. Press the Up/Down key repeatedly to select the time per update.

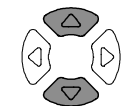

	DC	AC≤ 100Hz	AC≤ 2kHz	AC> 2kHz	AC≥ 1MHz
Slow	900ms	1.3s	600ms	600ms	620ms
Med	120ms	1.2s	470ms	450ms	470ms
Fast	60ms	650ms	180ms	150ms	150ms
Max	30ms	600ms	120ms	75ms	120ms

Beep setting If the beep setting (page61) is active and the display is in Pass/Fail test mode, it might sound continuously depending on the measurement result. If this happens, press the Sing/Rep key and set the mode to Single. Then turn Off the buzzer.



Hide drive Voltage/Current

Background The drive voltage and current shows the actual voltage/current level applied to the device under test.

V_m: 549.8mV
I_m: 724.9pA

Panel operation 1. Press the Code key.



2. Enter the system code using the numerical keys, then press the Enter key.

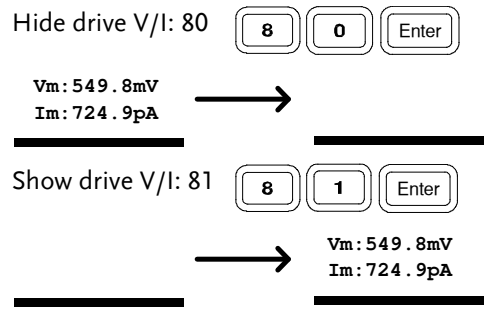

PASS-FAIL MODE

In the Pass/Fail test mode, measurement results are compared with user-defined limits and the results are displayed. Two types of tests are available: Single and Multi-Step. The Single test shares the same interface with the basic measurement, and tracks one item. The Multi-Step test runs a program comprised of multiple measurement items with different parameters.

Single-step configuration	Overview	60
	Configure beep setting	61
	Configure the Average	62
	Select test item and scale (Pass/Fail test)	63
	Set parameters.....	64
Single-step run	Run in Absolute mode.....	66
	Run in Percentage mode	67
	Run in Delta mode.....	68
	Use display value as nominal.....	69

Multi-step configuration	Overview	70
	Configure beep setting	72
	Configure the Average	73
	Enter multi-step mode.....	74
	Create new program	74
	Edit program step	76
	Copy (duplicate) program step	79
	Delete program step	79
<hr/>		
Multi-step run	Run program	80
<hr/>		
Multi-step file operation	Save program	83
	Recall (load) existing program.....	85
	Delete existing program	86

Single-Step Test Configuration

Overview

Background / test type Pass/Fail test checks whether the measurement result sits between the Hi(high) and Lo(low) limit. Three methods are available: absolute limit, percentage and delta limit.

Absolute limit The Hi and Lo limit are defined by absolute values.

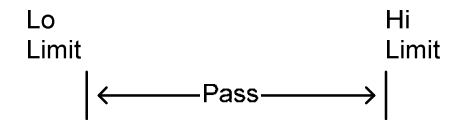

Percentage limit The Hi and Lo limit are defined by the distance (percentage) from the Nominal value.

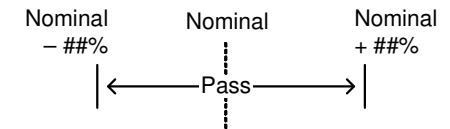

Delta limit The Hi and Lo limit are defined by the difference from the nominal value.

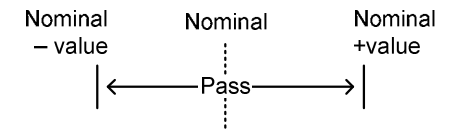

Test item	Cs Series capacitance	X	Reactance
	Cp Parallel capacitance	B	Susceptance
	Ls Series inductance	Z	Impedance
	Lp Parallel inductance	Y	Admittance
	Rs Series resistance	Rdc	DC Resistance

R_P Parallel resistance θ Angle

For detailed description of each item, see page37.

Configure beep setting

Background The beep sounds when the pass/fail test result matches the setting: failed or passed.

- Panel operation** 1. Press the Menu key, then F5 (System). The system configuration appears.

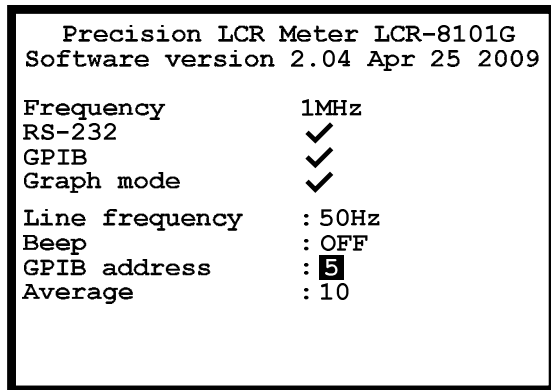
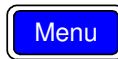

2. Press the Up/Down key and move the cursor to Beep.



Beep : **OFF**

3. Press the Left/Right key to select the beep setting, Off, Pass, or Fail.



- Off Beep is turned Off
- Pass Beeps when the test result is pass
- Fail Beeps when the test result is fail

Beep in repetitive mode If the repetitive measurement is On, the beep might sound continuously. If this becomes a problem, either use the Single mode (press Sing/Rep key) or turn Off the beep.

Configure the Average

Background The Average function sets the number of samples used, which are then averaged as the final output. The number of samples varies from 1 to 256.

- Panel operation** 1. Press the Menu key, then F5 (System). The system configuration appears.

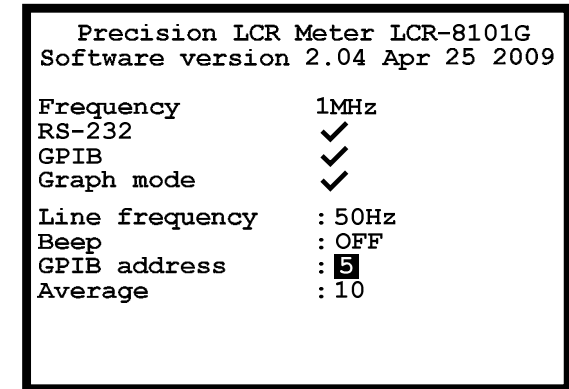
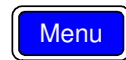

2. Press the Up/Down key and move the cursor to Average.

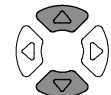

Average : **10**

3. Use the number pad to enter the number of samples to be averaged. A maximum of 256 samples can be selected for averaging.

Average: 10

Select test item and scale (Pass/Fail test)

Test item To select the first measurement item, press F1 repeatedly. **F 1**

C L X B Z Y

To select the second measurement item, press F2 repeatedly. **F 2**

Q D R G

Circuit model To select the circuit model, series or parallel, press F3 repeatedly. **F 3**

Scale Press F4 (Show/Hide scale) to select scale (Pass/Fail test). **F 4**

Normal

Pass/Fail test

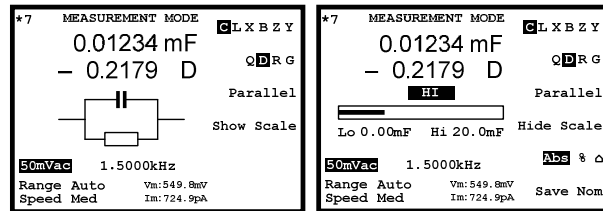

Normal mode For Normal (basic) mode details, see page36.

Set parameters

For more detailed descriptions, see Basic measurement, page47.

How to edit Example **1 0 0 m V/A Enter**

Backspace All clear **Clear**

Increase Decrease

When the entered value does not fit in the range, the nearest available value is selected.

Nearest Available

When the wrong unit (such as Ω) is entered, the value is cancelled.

Unit Mismatched

Measurement range (to Auto) Press the Left/Right key repeatedly to move the cursor to Range position, and use the Up/Down key to select Auto (if necessary).

Range Auto
Speed Slow

Single mode Press the Sing/Rep key repeatedly to select Single (manual trigger). To trigger measurement, press the Trigger key. **Sing/Rep**

Repetitive mode Press the Sing/Rep key repeatedly to select Rep (automatic trigger). Press the Left/Right key repeatedly to move the cursor to Speed, and use the Up/Down key to select the update rate. **Sing/Rep**

Frequency (except Rdc) Press the Left/Right key repeatedly to move the cursor to Frequency, and use the numerical and unit keys to enter the value.

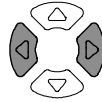

2.00 Vac **195.00 kHz**

Frequency step resolution For frequency increase/decrease using Up/Down keys, fine and coarse step settings are available.

Press the Code key and enter 10 (Fine) or 11 (Coarse).



Voltage Press the Left/Right key repeatedly to move the cursor to Voltage, and use the numerical and unit keys to enter the value.

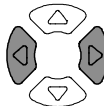

2.00 Vac **195.00 kHz**

Single-Step Test Run

Run in Absolute mode

1. Press F5 to select Absolute measurement.



Abs % ▴

2. Use the Left/Right key to move the cursor to Hi/Lo value for editing.



Lo **0.00mF** Hi **20.0mF**

3. Use the numerical keys and unit keys to enter the value. The editing value appears at the bottom left corner of the display.

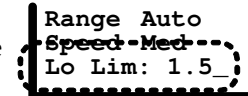

Example 1.2mΩ
 1 . 2 m Ω Enter

Backspace All clear
 Clear

Increase Decrease



Hi and Lo values are automatically swapped if necessary

Hi and Lo Swapped

4. The display updates the Hi/Lo result immediately. The result is pass if the bar stays in the central area. The buzzer sounds accordingly.



Run in Percentage mode

1. Press F5 to select Percentage measurement. 
Abs % 

2. Use the Left/Right key to move the cursor to Hi/Lo value or nominal value for editing. 

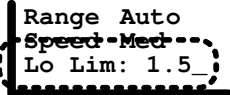

3. Use the numerical keys and unit keys to enter the value. The editing value appears at the bottom left corner of the display. 

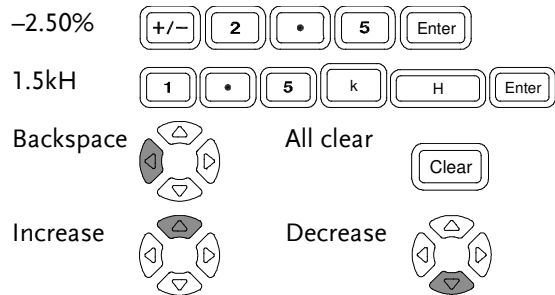

Hi and Lo values are automatically swapped if necessary

Hi and Lo Swapped

4. The display updates the Hi/Lo result immediately. The result is pass if the bar stays in the central area. The buzzer sounds accordingly.



Run in Delta mode

1. Press F5 to select Delta measurement. 
Abs % 

2. Use the Left/Right key to move the cursor to Hi/Lo value or nominal value for editing. 

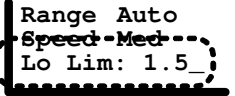

3. Use the numerical keys and unit keys to enter the value. The editing value appears at the bottom left corner of the display. 





Hi and Lo values are automatically swapped if necessary

Hi and Lo Swapped

- The display updates the Hi/Lo result immediately. The result is pass if the bar stays in the central area. The buzzer sounds accordingly.



Use display value as nominal

Panel operation (For Percentage and Delta only) The displayed value can be used as the nominal value. Press F6 (Save Nom) to copy the display value to the nominal value.



Multi-Step Test Configuration

Overview

Background The multi-step function can configure and run multiple measurement steps. Maximum 64 programs, 30 steps each, can be programmed and stored in the instrument.



Limit type Only the absolute limit testing is available. For percentage limit test, use the single mode (page60).

Test item	Cs Series capacitance	B	Susceptance
	Cp Parallel capacitance	G	Conductance
	Ls Series inductance	Z	Impedance
	Lp Parallel inductance	Y	Admittance
	Rs Series resistance	Rdc	DC Resistance
	Rp Parallel resistance	θ	Angle
	X		Reactance

For detailed description of each item, see page37.

Configure the Average

Background The Average function sets the number of samples used, which are then averaged as the final output. The number of samples varies from 1 to 256.

Panel operation 1. Press the Menu key, then F5 (System). The system configuration appears.  

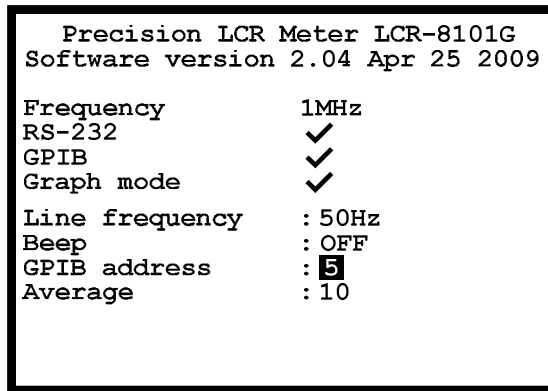

2. Press the Up/Down key and move the cursor to Average. 

Average : **10**

3. Use the number pad to enter the number of samples to be averaged. A maximum of 256 samples can be selected for averaging.



Average: 10   

Enter multi-step mode

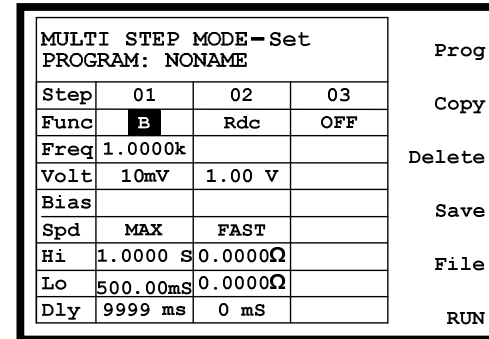
Panel operation Press the Menu key, then F3 (Multi Step). The multi-step mode menu appears. The last recalled program appears on the display.



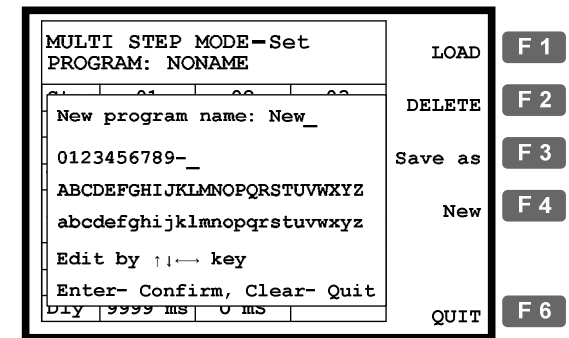

Create new program

Panel operation 1. In the multi-step mode, press F5 (File), then F4 (New). The new program name dialog opens.  





2. Enter the new program name using the arrow keys.

Move cursor (Left/Right keys)  JKLMNOPQRS

Enter the letter (Down key)  program name: N_

Delete one letter (Up key)  program name: _

- Press the Enter key to confirm the file name. To quit the new program mode, press the Clear key.  
- A blank program with the entered name appears.

MULTI STEP MODE-Set				Prog	F 1
PROGRAM: New				Copy	F 2
Step	01	02	03	Delete	F 3
Func	OFF	OFF	OFF	Save	F 4
Freq				File	F 5
Volt				RUN	F 6
Bias					
Spd					
Hi					
Lo					
Dly					





- Press F1 (Prog). Step 01 becomes active and changes to Ls measurement mode. For further editing details, see the next page. 



Step	01	→	Step	01
Func	OFF		Func	Ls



Edit program step

- How to edit parameter
- For selecting parameters, press F1 (Prog) repeatedly. 
 - For entering values, use the numerical and unit keys.

Example:

0.5kHz    

Backspace  All clear 

Increase  Decrease 

- How to move cursor
- To move the cursor to the editing point, use the arrow keys: up, down, left, and right. 

Note: The cursor cannot move into blank columns or steps.

- Panel operation
- Create new step
- To create a new step in a program, press F1 (Prog) at Func column "OFF". The step becomes active and the function changes to Ls. Up to 30 steps are available in a program. 

Step	01	→	Step	01
Func	OFF		Func	Ls

- Select item (function)
- Move the cursor to Func column, press F1 (Prog) repeatedly. The measurement item (function) changes in the following order. 

Ls → Lp → Q → Cs → Cp → D → Z → θ → Rs → Rp → X → G → B → Y → Rdc → Ls

Set frequency Move the cursor to Freq column.
Enter the frequency using the numerical keys and unit keys.

Func	Ls
Freq	500.00
Volt	2.00 V

Range 20Hz ~ 1MHz/5MHz/10MHz
5 digit resolution

Example:
0.5kHz (500Hz)

Set voltage Move the cursor to Volt column.
Enter the voltage using the numerical keys and unit keys.

Freq	500.00
Volt	2.00 V
Bias	

Range 10mV ~ 2V (DC or AC≤3 MHz)
(1mV step) 10mV ~ 1V (AC>3 MHz)

Example:
100mV

Select data capture rate Move the cursor to Spd column.
Select the capture rate by pressing F1 (Prog) repeatedly.

Bias	
Spd	MAX
Hi	1.0000H

	DC	AC≤ 100Hz	AC≤ 2kHz	AC> 2kHz	AC≥ 1MHz
Slow	900ms	1.3s	600ms	600ms	620ms
Med	120ms	1.2s	470ms	450ms	470ms
Fast	60ms	650ms	180ms	150ms	150ms
Max	30ms	600ms	120ms	75ms	120ms

Set Hi limit Move the cursor to Hi column.
Enter the Hi limit using the numerical keys and unit keys.

Spd	MAX
Hi	1.0000H
Lo	0.0000H

Range follows the specification for each measurement item

Example: 1.5kH (for Ls)

Set Lo limit Move the cursor to Lo column.
Enter the Lo limit using the numerical keys and unit keys.

Spd	MAX
Hi	1.0000H
Lo	0.0000H

Range follows the specification for each measurement item

Example: 1.0kH (for Ls)

Set trigger delay Move the cursor to Dly (Delay) column.
Enter the amount of trigger delay time using the numerical keys and unit keys.

Hi	1.0000H
Lo	0.0000H
Dly	10 ms

Range 0 (no delay) ~ 1000ms

Example: 10ms

Copy (duplicate) program step

Background Copying the step inserts a new, identical step next to the current step (= the step where the cursor resides).

Panel operation Press F2 (Copy). A new step with identical contents appears on the right side. **F 2**

Before (step 3 empty)				After (step 2 copied to 3)			
Step	01	02	03	Step	01	02	03
Func	B	Rdc	OFF	Func	B	Rdc	Rdc
Freq	1.0000k			Freq	1.0000k		
Volt	10mV	1.00 V		Volt	10mV	1.00 V	1.00 V
Bias				Bias			
Spd	MAX	FAST		Spd	MAX	FAST	FAST
Hi	1.0000 S	0.0000Ω		Hi	1.0000 S	0.0000Ω	0.0000Ω
Lo	500.00ms	0.0000Ω		Lo	500.00ms	0.0000Ω	0.0000Ω
Dly	9999 ms	0 ms		Dly	9999 ms	0 ms	0 ms

Delete program step

Background Deleting the step deleted the currently selected step (= where the cursor resides). The other step numbers are decreased by 1 (shifted to the left in the table).

Panel operation Press F3 (Delete). The current step is deleted, and the whole table shifts to the left. **F 3**

Before (step 2 deleted)				After (step 3 becomes 2)			
Step	01	02	03	Step	01	02	03
Func	B	G	Rdc	Func	B	Rdc	OFF
Freq	1.0000k			Freq	1.0000k		
Volt	10mV	1.20 V	1.00 V	Volt	10mV	1.00 V	
Bias				Bias			
Spd	MAX	MED	FAST	Spd	MAX	FAST	
Hi	1.0000 S	1.5000kS	0.0000Ω	Hi	1.0000 S	0.0000Ω	
Lo	500.00ms	0.0000S	0.0000Ω	Lo	500.00ms	0.0000Ω	
Dly	9999 ms	10 ms	0 ms	Dly	9999 ms	0 ms	

Multi-Step Program Run

Run program

Panel operation 1. When editing is completed, press F6 (Run) to run the multi-step program. The display changes to program running mode. **F 6**

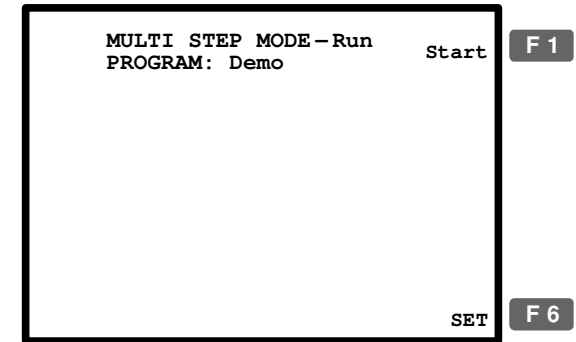

2. Press the Sing/Rep key to select Single (manual trigger) or Repetitive (automatic trigger). **Sing/Rep**

Manual trigger Starts running the program when the Trigger key or F1 (Start) is pressed. **Trig** **F 1**

Auto trigger Starts running the program when the LCR-8000G detects the DUT is connected to the fixture (scans the fixture continuously). Manual triggering is also available.

- In Manual (single) mode press F1 (Start) or the Trigger key to manually start the program. The test results show up according to the program contents.

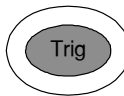

F 1

MULTI STEP MODE—Run					Start
PROGRAM: Demo					
Freq	Volt		Result		
1	1.2000k	1.00	Ls	9.8936mH	LO
2	10.000k	1.00	Q	22.708 Q	PASS
3	100.00k	1.00	Ls	10.852mH	HI
4	DC	1.00	Rdc	25.555 Ω	PASS

FAIL SET

Manual (single) Mode

- In Auto trigger mode, it will autoscan continuously and will not start until a DUT has been detected. To manually trigger the program, press F1 (Start) or the Trigger key.

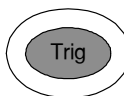

F 1

MULTI STEP MODE—Run					Start
PROGRAM: Demo					
Freq	Volt		Result		
1	1.2000k	1.00	Ls	9.8936mH	LO
2	10.000k	1.00	Q	22.708 Q	PASS
3	100.00k	1.00	Ls	10.852mH	HI
4	DC	1.00	Rdc	25.555 ?	PASS

FAIL Auto scanning... SET

Auto trigger (repetitive) mode

The rightmost row shows the result for each step.

LO Failed: below the Lo limit

HI Failed: above the Hi limit

PASS Passed

The left bottom corner shows the result for the whole program.

PASS All steps passed

FAIL One or more steps failed

- To return to the program setting menu, press F6 (Set).

F 6

Multi-Step Program File Operation

Save program

Save (overwrite) Press F4 (Save) to save the program being edited. A confirmation message appears on the display. **F 4**

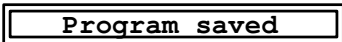

Save as (new program) 1. Press F5 (File), then F3 (Save As). The new program name dialogue appears. **F 5** **F 3**

MULTI STEP MODE-Set PROGRAM: NONAME	LOAD	F 1
Save program as: New_	DELETE	F 2
0123456789_	Save as	F 3
ABCDEFGHIJKLMN OPQRSTUVWXYZ	New	F 4
abcdefghijklmnopqrstuvwxyz		
Edit by ↑↓←→ key		
Enter- Confirm, Clear- Quit		
Dly 9999 ms 0 ms	QUIT	F 6

2. Enter the new program name using the arrow keys.

Move cursor (Left/Right keys) JKLMNOPQRS

Enter the letter (Down key) program name: N_

Delete one letter (Up key) program name: _

3. Press the Enter key to confirm the file name. To quit the Save as mode, press the Clear key.

4. The display goes back to the previous mode, with the program changed to the new name.

MULTI STEP MODE-Set PROGRAM: NEW				Prog
Step	01	02	03	Copy
Func	B	Rdc	OFF	Delete
Freq	1.0000k			Save
Volt	10mV	1.00 V		File
Bias				RUN
Spd	MAX	FAST		
Hi	1.0000 S	0.0000Ω		
Lo	500.00ms	0.0000Ω		
Dly	9999 ms	0 ms		

Recall (load) existing program

Panel operation 1. Press F5 (File). The file menu appears. **F 5**

2. Press F1 (Load). The existing programs appear, listed in alphabetical order. **F 1**

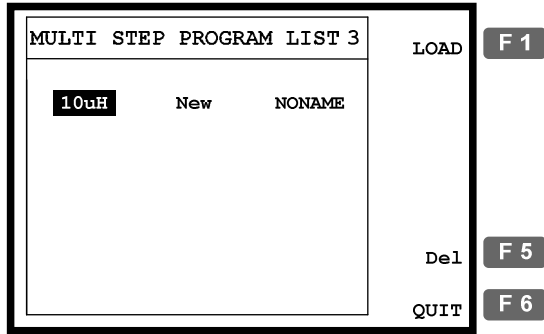

3. Use the arrow key to move the cursor to the program to be recalled (loaded). 

4. Press F1 (Load) to recall the selected program on the display. **F 1**

5. To cancel loading and go back to the previous menu, press F6 (Quit). **F 6**

Delete existing program

Recall program 1. Press F5 (File), then F2 (Delete). The existing programs appear, listed in alphabetical order. **F 5**

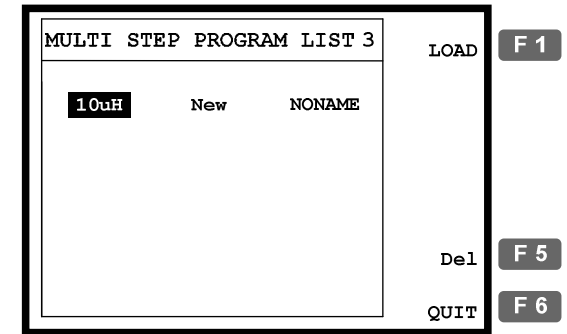

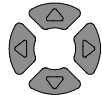
2. Use the arrow key to move the cursor to the program to be deleted. 

3. Press F5 (Del). The buzzer beeps and a warning sign appear. Press the Enter key (confirm) or the Clear key (cancel). **F 5**

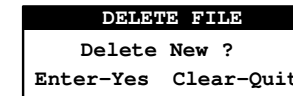

Note: the currently active program cannot be deleted. An error message appears.

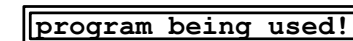

4. To go back to the previous menu without deleting any program, press F6 (Quit). **F 6**

G GRAPH MODE

The graph function shows the component characteristics in visual manner. Voltage and Frequency sweep are selectable for the horizontal scale. When the graph gets out of the vertical range, the LCR-8000G can automatically adjust the scale. Marker operation is available for detailed observation.

Item selection	Enter graph mode	88
	Select measurement item	89
Horizontal scale setting	Set horizontal axis (Voltage)	90
	Set horizontal axis (Frequency)	92
Vertical scale setting	Set vertical axis (Manual + Absolute)	94
	Set vertical axis (Manual + Percentage)	96
	Set vertical axis (Auto + Absolute)	98
	Set vertical axis (Auto + Percentage)	99
Speed/Step Setting	Select measurement speed (capture timing) .	101
	Select step size	102
Running Graph Measurement	Run measurement	103
	Adjust vertical scale	105
	Observe Graph Data	106

Item Selection

Enter graph mode

- Panel operation 1. Press the Menu key. The main menu appears.

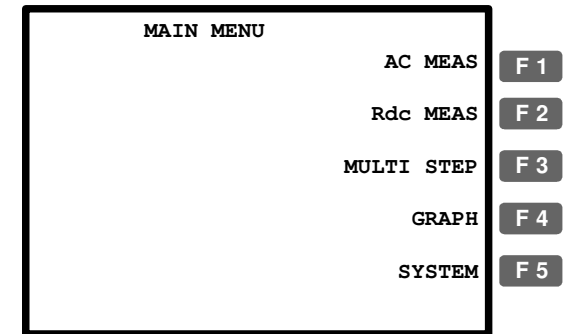

2. Press F4 (Graph). The Graph mode display appears.

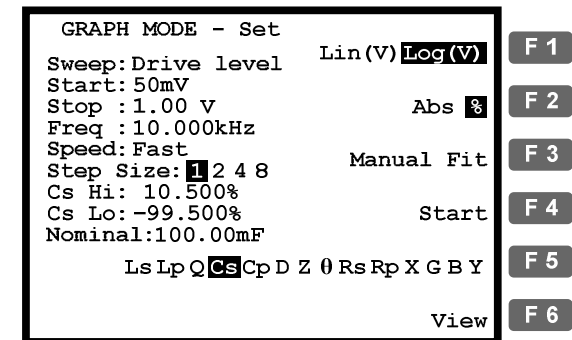

Select measurement item

Range	Ls	Series inductance	θ	Angle
	Lp	Parallel inductance	Rs	Series resistance
	Q	Quality factor	Rp	Parallel resistance
	Cs	Series capacitance	X	Reactance
	Cp	Parallel capacitance	G	Conductance
	D	Dissipation factor	B	Susceptance
	Z	Impedance	Y	Admittance

For detailed description of each item, see page37.

Panel operation Press F5 repeatedly to select the graph measurement item. **F 5**

Ls Lp Q Cs Cp D Z θ Rs Rp X G B Y

Horizontal Scale Setting

Set horizontal axis (Voltage)

Background The X (horizontal) axis is selectable from Voltage and Frequency sweep.

- When Voltage sweep is selected: measurement Frequency is fixed
- When Frequency sweep is selected: measurement Voltage is fixed

Select Drive level (Voltage) 1. Press the Up/Down key and move the cursor to Sweep.

Sweep: Frequency

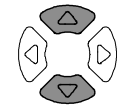

2. If necessary, press the Left/Right key to change the sweep setting to Voltage (Drive Level).

Frequency → Drive Level

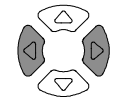

Set start Voltage 3. Press the Up/Down key and move the cursor to Start.

Start: 50mV

Use the numerical keys to enter the starting Voltage.

Range 10mV ~ 2V (AC≤3 MHz)
10mV ~ 1V (AC>3 MHz) *1mV step

100mV **1** **0** **0** **m** **V/A** **Enter**

1V **1** **V/A** **Enter**

Backspace All clear **Clear**

If a wrong unit is entered, the value is cancelled.

Unit Mismatched

If a value outside of the range is entered, the closest available value is automatically selected.

Nearest Available

If the entered start Voltage level is higher than the stop Voltage, the two values are swapped.

Hi and Lo Swapped

- Set stop Voltage
- Repeat the above step for the stop Voltage.
Stop: 1.00 V
 Range 10mV ~ 2V (AC≤3 MHz)
 10mV ~ 1V (AC>3 MHz) *1mV step
 (Stop Voltage must be higher than the Start Voltage)



- Set measurement Frequency
- Use the Up/Down key to move the cursor to Frequency setting (Freq).
Freq : 10.000kHz
 Use the numerical keys to enter the measurement frequency.
 Range 20Hz ~ 1MHz/5MHz/10MHz
 50Hz
 1MHz
 Backspace  All clear

- Select Lin/Log scale
- Press F1 to select the horizontal scale, Linear or Logarithmic.
Lin (V) Log (V)

Set horizontal axis (Frequency)

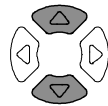
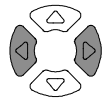
Background	The X (horizontal) axis is selectable from Voltage and Frequency sweep. <ul style="list-style-type: none"> When Voltage sweep is selected: measurement Frequency is fixed When Frequency sweep is selected: measurement Voltage is fixed
------------	---

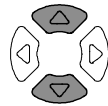
- Select Frequency
- Press the Up/Down key and move the cursor to Sweep.
Sweep: Drive Level 
 - If necessary, press the Left/Right key to change the sweep setting to Frequency.
Drive Level → **Frequency** 

- Set start Frequency
- Press the Up/Down key and move the cursor to Start.
Start: 20.000Hz 
 Use the numerical keys to enter the starting Frequency.
 Range 20Hz ~ 1MHz/5MHz/10MHz
 (stop Frequency must be higher than the start Frequency)
 50Hz
 1.2kHz
 Backspace  All clear

If a wrong unit is entered, the value is cancelled.

Unit Mismatched

If a value outside of the range is entered, the closest available value is automatically selected.

Nearest Available

If the entered start Frequency is higher than the stop Frequency, the two values are swapped.

Hi and Lo Swapped

Set stop Frequency

- Repeat the above step for the stop Frequency.

Stop: 10.000kHz

Range 20Hz ~ 1MHz/5MHz/10MHz

(stop Frequency must be higher than the start Frequency)

Set measurement Voltage

- Use the Up/Down key to move the cursor to Voltage setting (Level).

Level: 1.00 V

Use the numerical keys to enter the measurement Voltage.

Range 10mV ~ 2V (AC<3 MHz)

10mV ~ 1V (AC>3 MHz)

100mV

1V

Backspace  All clear

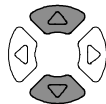

Select Lin/Log scale

- Press F1 to select the horizontal scale, Linear or Logarithmic.

F 1

Lin (Hz) Log (Hz)

Vertical Scale Setting

Set vertical axis (Manual + Absolute)

Background	The Y (vertical) axis configuration is available for: <ul style="list-style-type: none"> Manual or Automatic fit: Selects whether the vertical range is manually set or automatically adjusted as the graph is plotted. Absolute or Percentage: Selects how the vertical range is defined, as absolute values (minimum and maximum) or percentage of the nominal (center) value.
------------	--

Panel operation

- Press F2 to select Abs.

F 2

Abs %

- Press F3 to select Manual Fit.

F 3

Manual Fit

- The maximum (Hi) and minimum (Lo) level of the vertical axis appears.

Step Size: 1 2 4 8

Cs Hi: 5.8240mF

Cs Lo: 3.5626mF

Set Hi level

- Press the Up/Down key to move the cursor to Hi level.

Cs Hi: 5.8240mF

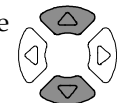

- Use the numerical keys to enter the Hi level.

Range According to each measurement item (see page37).

1.2mΩ

1.5kH

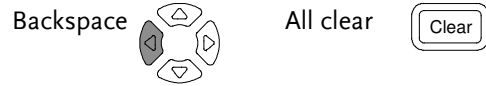

If a wrong unit is entered, the value is cancelled.

Unit Mismatched

If a value outside of the range is entered, the closest available value is automatically selected.

Nearest Available

If the entered Lo level is higher than the Hi level, the two values are swapped.

Hi and Lo Swapped

Set Lo level

6. Press the Up/Down key to move the cursor to Lo level and repeat the same step.

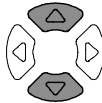

Cs Lo: 3.5626mF

Set vertical axis (Manual + Percentage)

Background	The Y (vertical) axis configuration is available for: <ul style="list-style-type: none"> • Manual or Automatic fit: Selects whether the vertical range is manually set or automatically adjusted as the graph is plotted. • Absolute or Percentage: Selects how the vertical range is defined, as absolute values (minimum and maximum) or percentage of the nominal (center) value.
------------	--

- Panel operation
1. Press F2 to select % (Percentage). **F 2**
Abs %
 2. Press F3 to select Manual Fit. **F 3**
Manual Fit
 3. The Hi percentage, Lo percentage, and the nominal value of the vertical axis appear.
Step Size: 1 2 4 8
Cs Hi: 10.500%
Cs Lo: -19.500%
Nominal: 100.00mF

Set Hi level

4. Press the Up/Down key to move the cursor to Hi percentage.

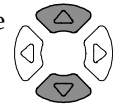

Cs Hi: 10.500%

5. Use the numerical keys to enter the percentage.

Range -1.0×10^{12} (Tera) ~ 1.0×10^{12} (Tera) %

50% **5 0 Enter**

1200% **1 . 2 k Enter**



If a wrong unit is entered, the value is cancelled.

Unit Mismatched

If the entered Hi level is lower than the Lo level, the two values are swapped.

Hi and Lo Swapped

Set Lo level

6. Press the Up/Down key to move the cursor to Lo percentage and repeat the same step.

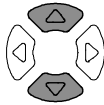

Cs Lo: -19.500%

Range -1.0×10^{12} (Tera) ~ 1.0×10^{12} (Tera) %

Set Nominal

7. Press the Up/Down key to move the cursor to Nominal.

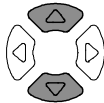

Nominal: 1.0000mF

8. Use the numerical keys to enter the nominal value on which the Hi and Lo percentages are based.

Range According to each measurement item (see page37).

1.2mΩ

1.5kH

Backspace All clear

If a wrong unit is entered, the value is cancelled.

Unit Mismatched

If a value outside of the range is entered, the closest available value is automatically selected.

Nearest Available

Set vertical axis (Auto + Absolute)

- Background The Y (vertical) axis configuration is available for:
- Manual or Automatic fit: Selects whether the vertical range is manually set or automatically adjusted as the graph is plotted.
 - Absolute or Percentage: Selects how the vertical range is defined, as absolute values (minimum and maximum) or percentage of the nominal (center) value.

Panel operation 1. Press F2 to select Abs (Absolute). **F 2**
Abs %

2. Press F3 to select Auto Fit. **F 3**
Auto Fit

3. Nothing new appears on the display: the LCR-8000G automatically configures the vertical scale according to the measured data.



Step Size: 1 2 4 8



Set vertical axis (Auto + Percentage)

Background The Y (vertical) axis configuration is available for:

- Manual or Automatic fit: Selects whether the vertical range is manually set or automatically adjusted as the graph is plotted.
- Absolute or Percentage: Selects how the vertical range is defined, as absolute values (minimum and maximum) or percentage of the nominal (center) value.

- Panel operation**
1. Press F2 to select % (Percentage). 
Abs %
 2. Press F3 to select Auto Fit. 
Auto Fit
 3. The nominal value appears on the display.
Step Size: 1 2 4 8
Nominal: 1.0000mF

Set Nominal level

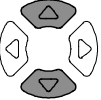
4. Press the Up/Down key to move the cursor to Nominal. 
Nominal: 1.0000mF

5. Use the numerical keys to enter the nominal value on which the Hi and Lo percentages are based.

Range According to each measurement item (see page37).

1.2mΩ      

1.5kH      

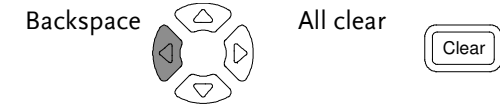

If a wrong unit is entered, the value is cancelled.

Unit Mismatched

If a value outside of the range is entered, the closest available value is automatically selected.

Nearest Available

6. The LCR-8000G automatically configures the percentage (below and above the nominal level) of the vertical scale.

Speed / Step Setting

Select measurement speed (capture timing)

Background The speed is the same setting used in the basic measurement (page56), except in the graph mode, maximum speed setting is not available.

Panel operation 1. Press the Up/Down key and move the cursor to Speed.
Speed: Fast

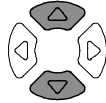

2. If necessary, press the Left/Right key to change the setting (time per capture).

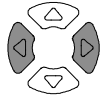

	DC	AC≤ 100Hz	AC≤ 2kHz	AC> 2kHz	AC≥ 1MHz
Slow	900ms	1.3s	600ms	600ms	620ms
Med	120ms	1.2s	470ms	450ms	470ms
Fast	60ms	650ms	180ms	150ms	150ms

Select step size

Background The step size selects whether to plot every captured data (step size 1) or to plot only the selected data (step size 2, 4, 8 = every 2, 4, 8 data).
Step size 1: detailed graph, slow capturing
Step size 2, 4, 8: simplified graph, fast capturing

Panel operation 1. Press the Up/Down key and move the cursor to Step size.
Step Size: 1 2 4 8

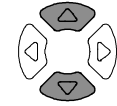

2. If necessary, press the Left/Right key to change the setting.
Range 1 (plot all data), 2, 4, 8

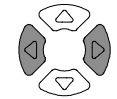

Running Graph Measurement

Run measurement

- Panel operation
1. When the configuration is completed, press F4 (Start) to start the graph measurement. **F 4**
 2. The display changes into graph mode and starts plotting the measurement data.

Measurement Ongoing

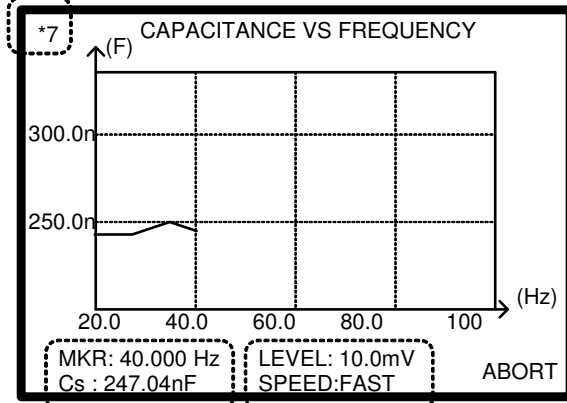

Latest Measurement Data (Updated) Drive Level (or Frequency) and Speed

3. To abort the measurement, press F6 (Abort). **F 6**
4. When completed, the buzzer sounds once and the display shows the whole plotted data.

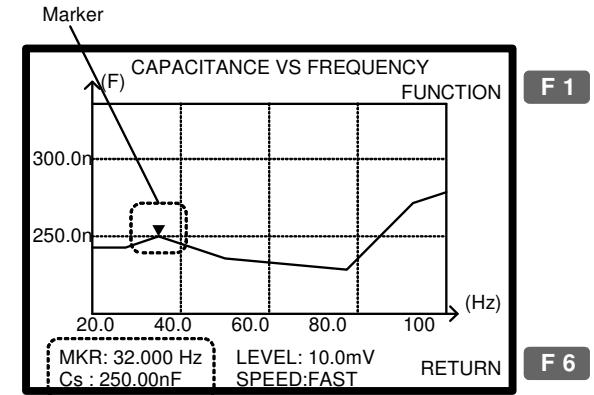

Marker position and Measurement data

5. To go back to the configuration mode, press F6 (Return). **F 6**

Adjust vertical scale

Background When the measured data does not fit into the original vertical scale, use this function so that the LCR-8000G automatically adjusts the scale to include the whole plotted data.

- Panel operation**
1. If part or all of the plotted data are out of the vertical range, use the automatic fit function. Press F1 (Function), then F2 (Fit).

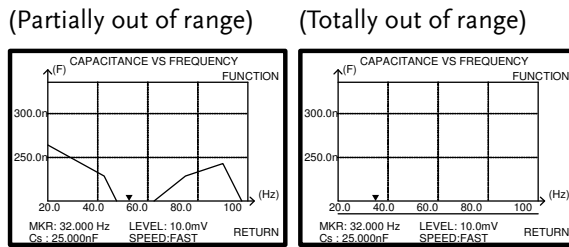

2. The vertical range is automatically adjusted to include the whole plotted data.

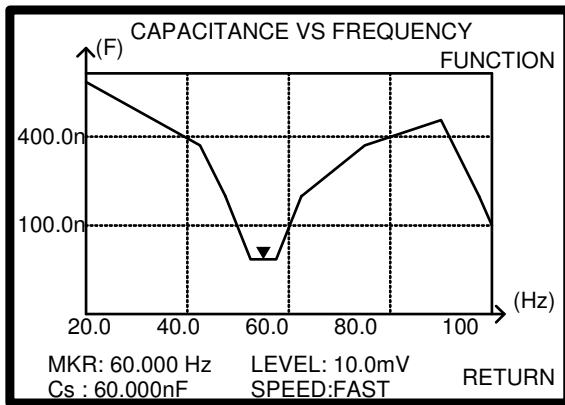

Observe Graph Data

Background When the graph is completed (page103) and the vertical scale is adjusted (page105), use the marker to observe the measurement data in detail.

In the configuration mode, if the graph is already available, it can be viewed by pressing F6 (View).

- Panel operation**
1. To move the marker, press the Left/Right key. As the marker moves, the marker position and measurement data changes.

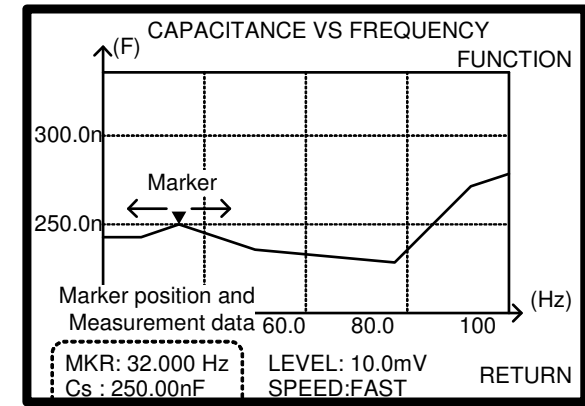
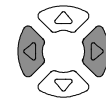

- Move marker to the peak**
2. To move the marker to the peak of the plot, press F1 (Function) and F3 (Peak). Press F1 (View) to go back to the previous display.

- Move marker to the bottom**
3. To move the marker to the bottom of the plot, press F1 (Function) and F4 (Dip). Press F1 (View) to go back to the previous display.

REMOTE CONTROL

This chapter describes basic aspects of IEEE488.2 based remote control. Both RS-232C and GPIB interface can be used for remote control.

Interface Configuration	Configure RS-232C interface.....	108
	Configure GPIB interface.....	109
Command syntax	Command Syntax	111
Command set	System command	112
	Measurement command	113
	Multi-step program command.....	115
	Calibration command	117
	Graph command.....	118

Interface Configuration

Configure RS-232C interface

RS-232C configuration	Connector	DB-9, Male
	Baud rate	9600
	Parity	None
	Data bit	8
	Stop bit	1

Connect the RS-232C cable to the rear panel port: DB-9 male connector.

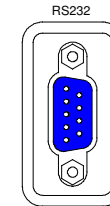

Pin assignment

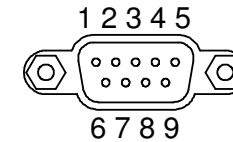

- 2: RxD (Receive data)
- 3: TxD (Transmit data)
- 5: GND
- 7: RTS (Request to send)
- 8: CTS (Clear to send)
- 1, 4, 6, 9: No connection

PC connection

Use the Null Modem connection as in the below diagram.

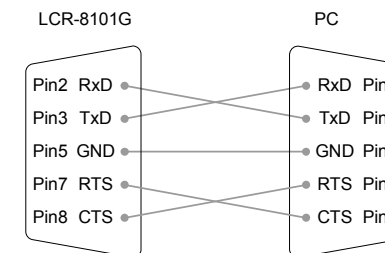

Configure GPIB interface

Connection Connect the GPIB cable to the rear panel port: 24-pin female connector.

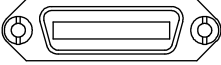

Pin assignment



Pin1	Data line 1	Pin13	Data line 5
Pin2	Data line 2	Pin14	Data line 6
Pin3	Data line 3	Pin15	Data line 7
Pin4	Data line 4	Pin16	Data line 8
Pin5	EOI	Pin17	REN
Pin6	DAV	Pin18	Ground
Pin7	NRFD	Pin19	Ground
Pin8	NDAC	Pin20	Ground
Pin9	IFC	Pin21	Ground
Pin10	SRQ	Pin22	Ground
Pin11	ATN	Pin23	Ground
Pin12	Shield (screen)	Pin24	Signal ground

- GPIB constraints**
- Maximum 15 devices altogether, 20m cable length, 2m between each device
 - Unique address assigned to each device
 - At least 2/3 of the devices turned On
 - No loop or parallel connection

Select GPIB address

1. Press the Menu key and F5 (System).
The system configuration appears.

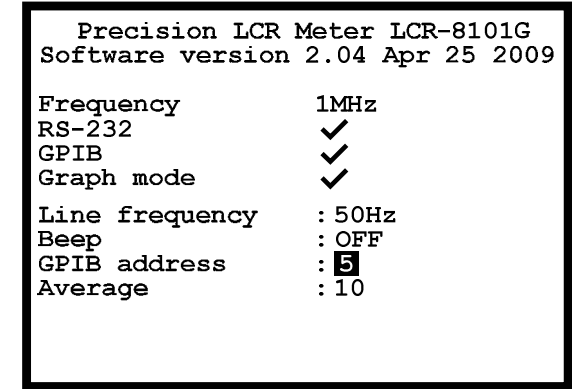

2. Press the Up/Down key and move the cursor to GPIB.

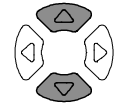

GPIB address : 5

3. Use the numerical keys to enter the GPIB address, 1 ~ 30.

GPIB address : 30

Address 5

Command Syntax

- Compatible standard
- IEEE488.2, 1992 (fully compatible)
 - SCPI, 1994 (partially compatible)

Command format `trig:del:mod <NR1>LF`

1: command header
 2: single space
 3: parameter
 4: message terminator

Parameter	Type	Description	Example
	<Boolean>	boolean logic	0, 1
	<NR1>	integers	0, 1, 2, 3
	<NR2>	decimal numbers	0.1, 3.14, 8.5
	<NR3>	floating point	4.5e-1, 8.25e+1
	<disc>	discrete data	on, off, max

Message terminator

Terminates a command line. Note that the LCR-8000G accepts only LF (line feed) as the terminator.

 LF line feed code

- Note
- Commands introduced here are described in abbreviated style (same functionality)
 - Commands are non-case sensitive.

Command Set

System command

*cls	Clears the Event Status Register and associated status data structure.
*ese <NR1>	Sets or returns the current contents of the Standard Event Status Enable Register as an integer in the range 0 to 255.
*ese?	
*esr?	Returns the current contents of the Standard Event Status Register as an integer in the range 0 to 255. It also clears ESR.
*idn?	Returns the LCR identification: Manufacturer, Model No, Serial No, Firmware version. Example: GW INSTEK, 8101, 0, 2.04
*loc	Sets the instrument to local state.
*opc	Sets the OPC bit of the ESR register.
*opc?	Always returns 1 as instrument commands are always processed sequentially.
*opt?	Returns the hardware options installed in the instrument. Example: 1MHz, GPIB, RS232, GRAPH MODE
*rst	Resets the LCR-8000G.
*sre <NR1>	Sets or returns the current contents of the Service Request Enable Register as an integer in the range 0 to 63 and 128 to 255.
*sre?	
:stat:oper:con?	Reads Status Operation Condition register.
:stat:oper:enab <NR1>	Sets Status Operation Enable register.
:stat:oper:even?	Reads Status Operation Event register.

*stb?	Returns the current contents of the Status Byte with the Master Summary bits as an integer in the range 0 to 255. Bit 6 represents Master Summary Status rather than Request Service.
*trg	Triggers a direct measurement, but does not return the results to the controller. This is the same as a GET (Group Execute Trigger) command.
*wai	Command has no effect as commands are processed sequentially.

Measurement command

:dump-bmp	Returns the current display as a windows compatible bitmap.
:beep <disc>	Sets or returns the buzzer condition.
:beep?	Set parameter: off (disabled), pass (beeps when passed), fail (beeps when failed) Return parameter: 0 (off), 1 (pass), 2 (fail)
:loc-trig <NR1>	Turns On/Off local triggering in remote control Parameter: on (local control), off (remote control)
:meas:equ-cct <NR1>	Selects or returns equivalent circuit. Send parameter: ser, par
:meas:equ-cct?	Return parameter: 0 (parallel), 1 (series)
:meas:freq <NR3>	Sets or returns frequency of AC measurement in Hz.
:meas:freq?	Parameter example: (1kHz) 1k, 1000 Hz, 1E3
:meas:func <disc>	Selects first or second AC measurement function. Parameter: c, l, x, b, z, y, q, d, r, g Example: :meas:func:c;d (C+D measurement)
:meas:func:major ?	Returns the first AC function. Parameter: 0 (C), 1 (L), 2 (X), 3 (B), 4 (Z), 5 (Y)

:meas:func:minor ?	Returns the second AC function. Parameter: 0 (Q), 1 (D), 2 (R), 3 (G) If the first function is Z or Y, this command returns the last non-polar setting
:meas:hi-lim <NR2>	Sets or returns scale high limit as percentage. Example: :meas:hi-lim 5.0 (+5.0%)
:meas:hi-lim?	
:meas:lev <NR2>	Sets or returns drive level for currently selected test.
:meas:lev?	Parameter example: (200mV) 0.2V, 200m
:meas:limit <disc>	Sets or returns percentage, absolute or delta scale limits.
:meas:limit?	Send parameter: abs (absolute), perc (percentage), delta (delta) Return parameter: 0 (absolute), 1 (percentage), 2 (delta)
:meas:lo-lim <NR2>	Sets or returns scale low limit as percentage. Example: :meas:lo-lim -5.0 (-5.0%)
:meas:lo-lim?	
:meas:nom <NR3>	Sets or returns nominal value for scale. Send parameter: according to the active unit (1e-6f = 1uF)
:meas:nom?	Return parameter example: .10000000e-1 = 10mH
:meas:range <NR1>	Selects or returns auto-ranging or range-hold on range N.
:meas:range?	Send parameter: auto, hold, 1 ~ 7 Return parameter: 0 (auto), 1 ~ 7
:meas:scale <disc>	Shows or hides the scale bar or returns the status. Send parameter: on, off
:meas:scale?	Return parameter: 0 (scale hidden), 1 (scale visible)

:meas:speed <disc>	Selects or returns measurement speed. Send parameter: max, fast, med, slow
:meas:speed?	Return parameter: 0 (max), 1 (fast), 2 (med), 3 (slow)
:meas:test:ac	Selects AC measurement.
:meas:test:rdc	Selects Rdc measurement.
:meas:test?	Returns measurement type. Parameter: 0 (AC measurement), 1 (Rdc measurement)
:meas:trig	Triggers an AC or Rdc measurement manually. Returns the 1 st and 2 nd measurement (only the 1 st in Rdc). Example: -396.283E-6, 99.558 (uF/D)
:mode?	Query the currently selected operating mode.
:rep <disc> :rep?	Enables or returns repetitive measurements when unit is returned to local control. Send parameter: on (repetitive), off (single shot) Return parameter: 0 (single shot), 1 (repetitive) Example: :rep on (repetitive mode)
:trig	Triggers a measurement in the current mode.

Multi-step program command

:multi:set	Switches to the multi-step set-up page.
:multi:del	Removes a step in the program. Parameter: 1 ~ 30 Example: :multi:del 2 (deletes step 2)

:multi:delay <NR2>	Sets or returns trigger delay time for currently selected step in millisecond.
:multi:delay?	Parameter: 0ms ~ 1000ms Example: :multi:delay 10m (10ms)
:multi:freq <NR2> :multi:freq?	Sets or returns the frequency for the currently selected step in Hz. Parameter: 20 ~ 1/5/10MHz Example: :multi:freq 1e3 (1kHz)
:multi:func <NR1> :multi:func?	Sets or returns measurement type for the currently selected step. Send parameter: LS, LP, Q, CS, CP, D, Z, PHASE, RS, RP, X, G, B, Y, RDC Return parameter: 1 (Z), 2 (Ls), 3 (Lp), 4 (Cs), 5 (Cp), 7 (Y), 8 (G), 9 (P), 10 (Q), 11 (D), 12 (Rs), 13 (Rp), 14 (B), 15 (X), 16 (Rdc) Example: :multi:func ls (Series inductance)
:multi:hi-lim <NR3> :multi:hi-lim?	Sets or returns the higher test limit of the currently selected step. Example: :multi:hi-lim 10 (limit to 10.0)
:multi:lev <NR3> :multi:lev?	Sets or returns the drive level for the currently selected step in Voltage. Parameter: 10mV ~ 2V (DC/AC≤3 MHz) 10mV ~ 1V (AC>3 MHz) Example: :multi:lev 200m (200mV)
:multi:load <filename>	Loads an existed file to run or edit. Example: :multi:load demo (file name demo)
:multi:lo-lim <NR3> :multi:lo-lim?	Sets or returns the lower test limit of the currently selected step. Example: :multi:lo-lim -5 (limit to -5)

:multi:new <filename>	Create a new multi-step program. Example: :multi:new demo (file name demo)
:multi:res?	Query the results of the test for each step. Parameter: 0 (Pass), 1 (Fail Hi), 2 (Fail Lo) Example: 1, +1.5E-7, 0, -0.2E-4 (step 1 failed on high limit, step 2 passed)
:multi:run	Switches to the multi-step run page.
:multi:save	Save currently edited file.
:multi:speed <disc>	Sets or returns the measurement speed for the currently selected step.
:multi:speed?	Send parameter: Max, Fast, Med, Slow Return parameter: 0(Max), 1(Fast), 2(Med), 3(Slow) Example: :multi:speed max (maximum speed)
:multi:test <NR1>	Selects or returns the step being edited.
:multi:test?	Parameter: 1 ~ 30 Example: :multi:test 1(step 1 selected)
:multi:trig	Starts running multi-step measurements.

Calibration command

:cal:oc-trim <NR1>	Performs open circuit trimming. Parameter: 1 (Spot trim), 2 (<10kHz), 3 (<100kHz), 4 (All frequency) Example: :cal:oc-trim 4 (calibrate for all frequency)
:cal:sc-trim <NR1>	Performs short circuit trimming. Parameter: 1 (Spot trim), 2 (<10kHz), 3 (<100kHz), 4 (All frequency), 5 (Rdc) Example: :cal:sc-trim 4 (calibrate for all frequency)
:cal:res?	Returns the result of the calibration performed. Parameter: 0 (fail), 1 (pass)

Graph command

:graph	Select graphing mode / path.
: graph:func <disc>	Set the measurement function for the graph mode. Parameter: ls lp q cs cp d z phase rs rp x g b y rdc Example: :graph:func lp
: graph:func?	Returns the current measurement function of the graph mode. Return parameter: 1 (Z), 2 (Ls), 3 (Lp), 4 (Cs), 5 (Cp), 7 (Y), 8 (G), 9 (P), 10 (Q), 11 (D), 12 (Rs), 13 (Rp), 14 (B), 15 (X), 16 (Rdc), 0 (none)
: graph:sweep <disc>	Set the sweep mode for the graph mode. Parameter: freq, lev Example: (drive level) :graph:sweep lev
: graph:sweep?	Returns the current sweep mode of the graph mode. Return Parameter: 0(frequency), 1(drive level)
: graph:st <NR3>	Set the start frequency or level for the sweep. Parameter: (26 Hz) 26, 2.6e1, 2.600000e+01, .026k. Example: :graph:st 2.6e1
:graph:st?	Returns the start frequency or level of the sweep. Set the stop frequency or level for the sweep.
:graph:sp <NR3>	Parameter: (260 Hz) 260, 2.6e2, 2.600000e+02 (.26k) Example: :graph:sp 260
:graph:sp?	Returns the stop frequency or level of the sweep. Set the frequency if the sweep mode is drive level.
:graph:freq <NR3>	Parameter: (150 kHz) 150000, 1.5e5, 1.500000e+05 (1.5k) Example: :graph:freq 150k

:graph:freq?	Returns the frequency if the sweep mode is drive level
	Set the drive level if the sweep mode is frequency. Parameter: (.1 volts) .1v, 100m, 1e-1, 1.000000e-1
:graph:lev <NR3>	Example: :graph:lev 100m <ul style="list-style-type: none"> NOTE: e1 or e+1 is invalid for the lev command. 2 volts maximum.
:graph:lev?	Returns the drive level if the sweep mode is frequency.
	Set measurement speed for the sweep.
:graph:speed <disc>	Parameter: fast, med, slow Example: :graph:speed med
:graph:speed?	Returns the measurement speed of the sweep. Return Parameter: 1(fast), 2 (med), 3(slow)
:graph:step <NR1>	Select the number of pixels between each measured point. Parameter: 1(step size 1),2(step size 2),3(step size 4),4(step size 8) Example: (step size 8) :graph:step 4
:graph:step?	Query the current step size for the plot.
:graph:hi-lim <NR3>	Set the maximum value for Y-axis in the graph mode. Parameter: real number up to 1 ¹² (1e+12) Example: graph:hi-lim 8.5e9 Note: Set the low limit before setting the high limit. The graph limits will only work whilst the "autofit" function is set to "off"
:graph:hi-lim?	Returns the maximum value of Y-axis in the graph mode.

	Set the minimum value for Y-axis in the graph mode.
:graph:lo-lim <NR3>	Parameter: real number up to 1 ¹² (1e+12) Example: :graph:lo-lim -8.5e9 Note: The graph limits will only work whilst the "autofit" function is set to "off"
:graph:lo-lim?	Returns minimum value for Y-axis of the graph mode.
	Set the nominal value for the graph. Parameter: 3, 1e-1, 100e1 Example: :graph:nom 1e-1 Note: Nominal can only be set if the graph limit is set as a %(percentage)
:graph:nom?	Returns the current graph nominal.
	Selects the frequency scale type.
:graph:logf<disc>	Parameter: on, off Example: :(on) graph:logf on
:graph:logf?	Returns the current frequency scale type. Returned parameter 1(on), 0(off).
:graph:limit <disc>	Selects absolute or relative plotting. Parameter: perc(% relative), abs(absolute) Example: :graph:limit abs
:graph:limit?	Returns the current graph plotting mode. Returned parameter: 0(abs), 1(percentage)

	Returns the measurement from the current marker position.
:graph:mk?	Returned parameter: Depending on the measured parameters. Example: (Series inductance) -3.510606e-03 (mH) Note: A graph must be plotted first.
:graph:mkf <NR3>	Move the marker to the frequency nearest the supplied value. Parameter: (150 kHz) 150000, 150k, 1.5e5 Note: the marker must be within the limits of the currently drawn graph. The x-axis must be frequency bound.
:graph:mkf?	Returns the current marker frequency.
:graph:set	Go to the graph mode set-up page. Example: :graph:set
:graph:view	Redraw the graph. Example: :graph:view
:graph:autofit <disc>	Set auto-fit condition for the graph mode. Parameter: on, off Example: : graph:autofit on
:graph:autofit?	Query the auto-fit condition. Returned parameter: 0 (off), 1 (on)
:graph:fit	Fit the Y-axis scale to the current measurement data. Example: :graph:fit Note: The graph will only scale. It will not plot again.
:graph:trig	Start plotting a graph with the current settings. Example: :graph:trig

:graph:peak	Move the marker to the highest point on the current graph. Example: :graph:peak
:graph:dip	Move the marker to the lowest point on the current graph. Example: :graph:dip
:graph:print	Print the current graph on an Epson compatible printer. Example: :graph:print

CALIBRATION

Overview

Background Calibration (trimming) eliminates stray capacitance and series impedance from the testing fixture. It is required when using the instrument in a new environment, or using a new set of testing fixtures.

O/C trimming The testing fixture clips are separated by a distance equal to the normal testing position.

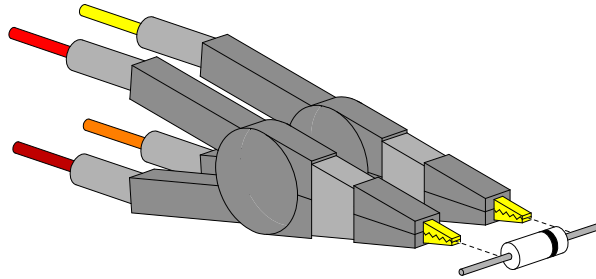

S/C trimming The testing fixture clips are connected by a piece of wire or a component lead (but no direct connection between the clips).

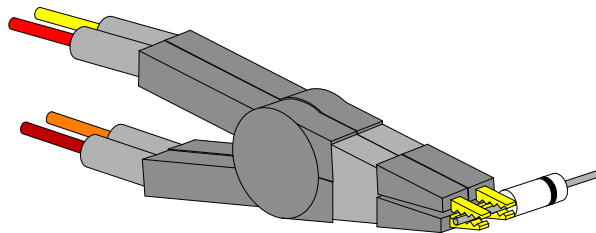

Alternative S/C trimming An alternative method of S/C trimming.

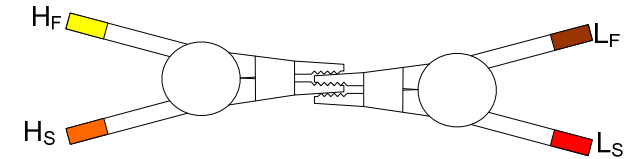

Trim the LCR-8000G

Fixture setting Prepare the fixture accordingly. (In order to run a complete trimming, both O/C and S/C trimming have to be done.)

O/C trimming

S/C trimming

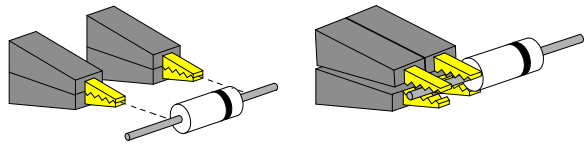

Alt. S/C trimming

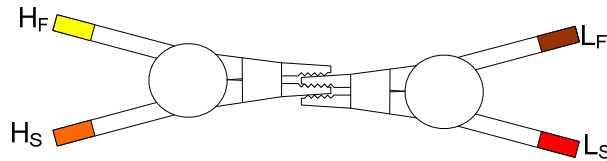

Panel operation

1. Press the Calibration key. The calibration mode menu appears.

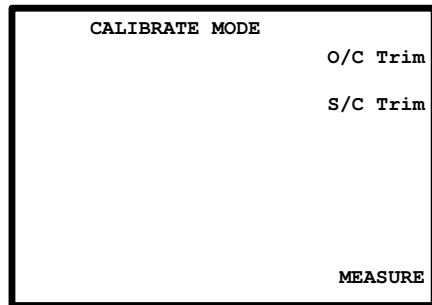

* To go back to the measurement mode, press F6 (MEASURE).

2. Press F1 (O/C Trim) or F2 (S/C Trim) to select the trimming mode.



3. The trimming menu appears.

S/C trimming

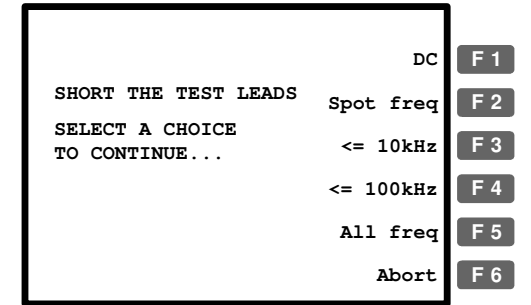

4. Always select F5 (All freq) when using the standard fixture set included in the LCR-8000G package.



DC (S/C trimming only) Trims at 0Hz.

Spot freq Trims at the frequency set in the measurement mode (page52).

<= 10kHz Frequency range is 0Hz ~ 10kHz.

<= 100kHz Frequency range is 0Hz ~ 100kHz.

All freq 0Hz~<1MHz (LCR-8101G)

0Hz~<5MHz (LCR-8105G)

0Hz~<10MHz (LCR-8110G)

Frequency limit example: When using a special fixture set, trimming failed at 50kHz which is outside of the test component range (up to 5kHz). In this case, use F3 (<= 10kHz).

5. The trimming starts and ends automatically.

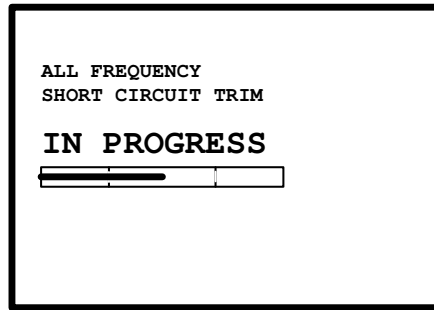

- Trim pass The display goes back to the calibration mode menu.
- Trim fail The Fail message appears on the display. Press any other key to go back to the original menu.

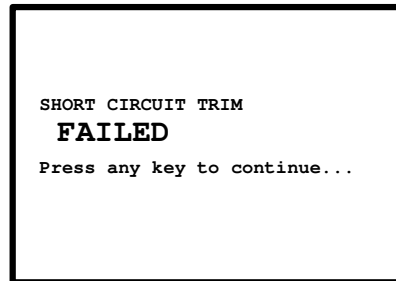

6. Switch the fixture setting from O/C to S/C (or from S/C to O/C) and repeat from step 1.

Note

When an “O/S Trim Error!” message appears, it means either that you haven’t properly performed an O/S trimming yet or that there is not an exactly matched calibration factor that can be used to calculate the most precise measurement reading based on the spot frequency you are using. When an “O/S Trimming Error!” message appears, the LCR-8000G will use an existing calibration factor at the closest frequency point to the spot frequency you are

using to calculate a measurement. However, this measurement is only an approximation. To obtain the most optimized measurement accuracy and to clear the warning message, it is best to perform O/S trimming again, based on the actual measuring frequency being used.

To get the most accurate measurement reading for the frequency spot you are currently using, any of the O/S

trimming options (All-frequency, $\leq 10\text{kHz}$, $\leq 100\text{kHz}$

and Spot frequency) can be used despite the differing number of total calibrated frequency points, see O/S Trimming Points section in the Appendix for details on page 131.

FAQ

Q1. The beep keeps sounding.

A1. The beep sounds according to the pass/fail test result, which in this case is set to repetitive mode. Do one of the following.

- Set the test mode to Single (manual trigger), so that the beep sounds only when the test is initiated manually. Press the Sing/Rep key to change the setting. For details, see page55.
- Turn Off the beep entirely. Press the Menu key, F5 (System), move the cursor to Beep and select Off using the arrow keys. For details, see page61.

Q2. Panel operation seems disabled.

A2. Panel (local) operation is disabled in the Remote control mode (page107). Press the Local key to bring back the instrument to local operation mode (remote control is cancelled).

Q3. I cannot see the display clearly.

A3. Use the display contrast knob on the rear panel to adjust the brightness.

For more information, contact your local dealer or GWInstek at www.gwinstek.com / marketing@goodwill.com.tw.

APPENDIX

Fuse Replacement

Step

1. Take off the power cord and remove the fuse socket using a minus driver.

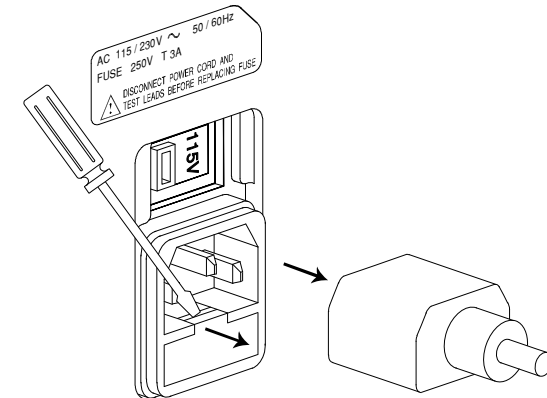

2. Replace the fuse in the holder.

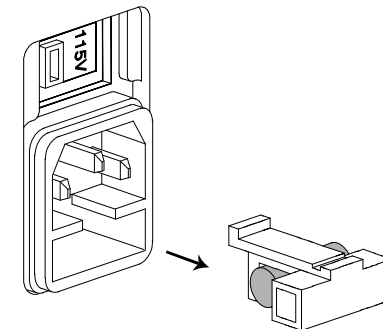

Rating

T3A/250V

O/S Trimming Points

All-Frequency O/S Trimming Point List

The frequency of the extra trimming point is the measurement frequency you were using before entering the calibration mode.

An “O/S Trim Error!” warning should not appear after running an all frequency O/S trimming.

Model	LCR-8101G	LCR-8105G	LCR-8110G
Trimming Point	13 points	17 points	22 points
1	20 Hz	20 Hz	20 Hz
2	100 Hz	100 Hz	100 Hz
3	300 Hz	300 Hz	300 Hz
4	1 kHz	1 kHz	1 kHz
5	3.3 kHz	3.3 kHz	3.3 kHz
6	10 kHz	10 kHz	10 kHz
7	20 kHz	20 kHz	20 kHz
8	50 kHz	50 kHz	50 kHz
9	100 kHz	100 kHz	100 kHz
10	200 kHz	200 kHz	200 kHz
11	500 kHz	500 kHz	500 kHz
12	1 MHz	1 MHz	1 MHz
13	Extra Trimming Point	2 MHz	2 MHz
14		3 MHz	3 MHz
15		4 MHz	4 MHz
16		5 MHz	5 MHz
17		Extra Trimming Point	6 MHz
18			7 MHz
19			8 MHz
20			9 MHz
21			10 MHz
22			Extra Trimming Point

≤100 kHz O/S Trimming Point List

The frequency of the extra trimming point is the measurement frequency you were using before entering the calibration mode.

“O/S Trim Error!” warning will still appear after running a ≤100

kHz trimming if you choose to use a measuring frequency higher

than 100 kHz or other than where you were when you ran the ≤100

kHz trimming.

LCR Models	LCR-8101G	LCR-8105G	LCR-8110G
Trimming Point	10 points	10 points	10 points
1	20 Hz	20 Hz	20 Hz
2	100 Hz	100 Hz	100 Hz
3	300 Hz	300 Hz	300 Hz
4	1 kHz	1 kHz	1 kHz
5	3.3 kHz	3.3 kHz	3.3 kHz
6	10 kHz	10 kHz	10 kHz
7	20 kHz	20 kHz	20 kHz
8	50 kHz	50 kHz	50 kHz
9	100 kHz	100 kHz	100 kHz
10	Extra Trimming Point	Extra Trimming Point	Extra Trimming Point

≤10 kHz O/S Trimming Point List

The frequency of the extra trimming point is the measurement frequency you were using before entering the calibration mode.

“O/S Trim Error!” warning will still appear after running a ≤10 kHz trimming if you choose to use a measuring frequency higher than 10 kHz or other than where you were when you ran the ≤10 kHz trimming.

LCR Models	LCR-8101G	LCR-8105G	LCR-8110G
Trimming Point	7 points	7 points	7 points
1	20 Hz	20 Hz	20 Hz
2	100 Hz	100 Hz	100 Hz
3	300 Hz	300 Hz	300 Hz
4	1 kHz	1 kHz	1 kHz
5	3.3 kHz	3.3 kHz	3.3 kHz
6	10 kHz	10 kHz	10 kHz
7	Extra Trimming Point	Extra Trimming Point	Extra Trimming Point

Spot Frequency O/S Trimming Point's List

There is no extra trimming point if you choose to use Spot Freq. O/S trimming.

“O/S Trim Error!” warning will still appear after running a spot frequency trimming if you choose to use a measuring frequency other than where you were when you ran the spot frequency O/S trimming.

LCR Models	LCR-8101G	LCR-8105G	LCR-8110G
Trimming Point	1 point	1 point	1 point
1	The frequency of the sole trimming point is the very measuring frequency you were using before entering the calibration mode.		

|Z| Accuracy Chart

Over the available frequency bands, the |Z| Accuracy Chart defines the measurement ranges available at specified accuracies. All curves assume that Slow measurement speed is used, that the analyzer has been trimmed at the frequency and level used for measurements, the factory calibration is valid and that the component under test is pure.

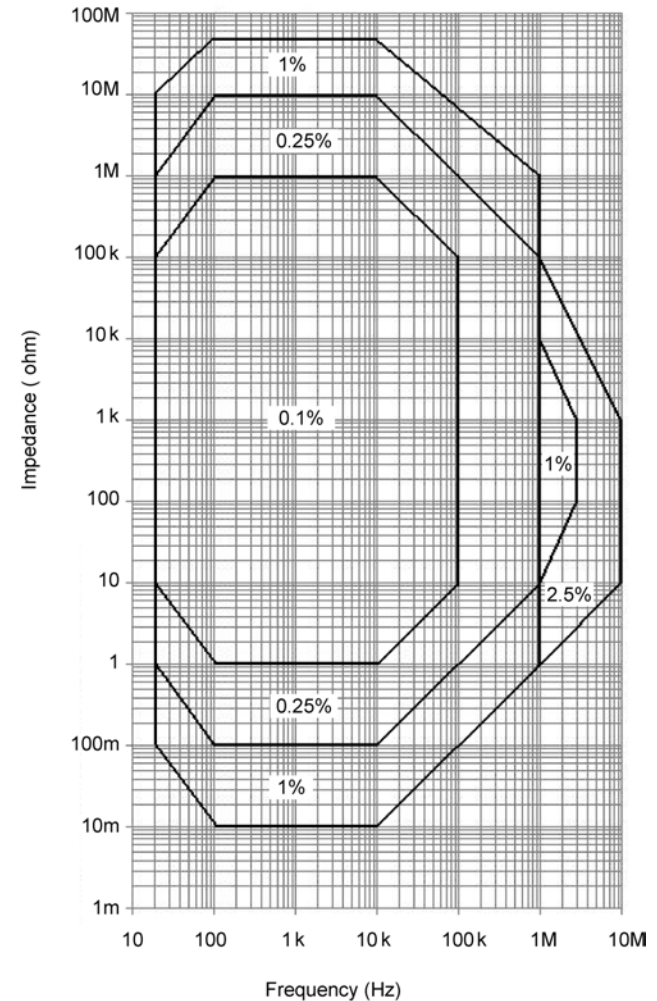

|Z| vs L, C Chart

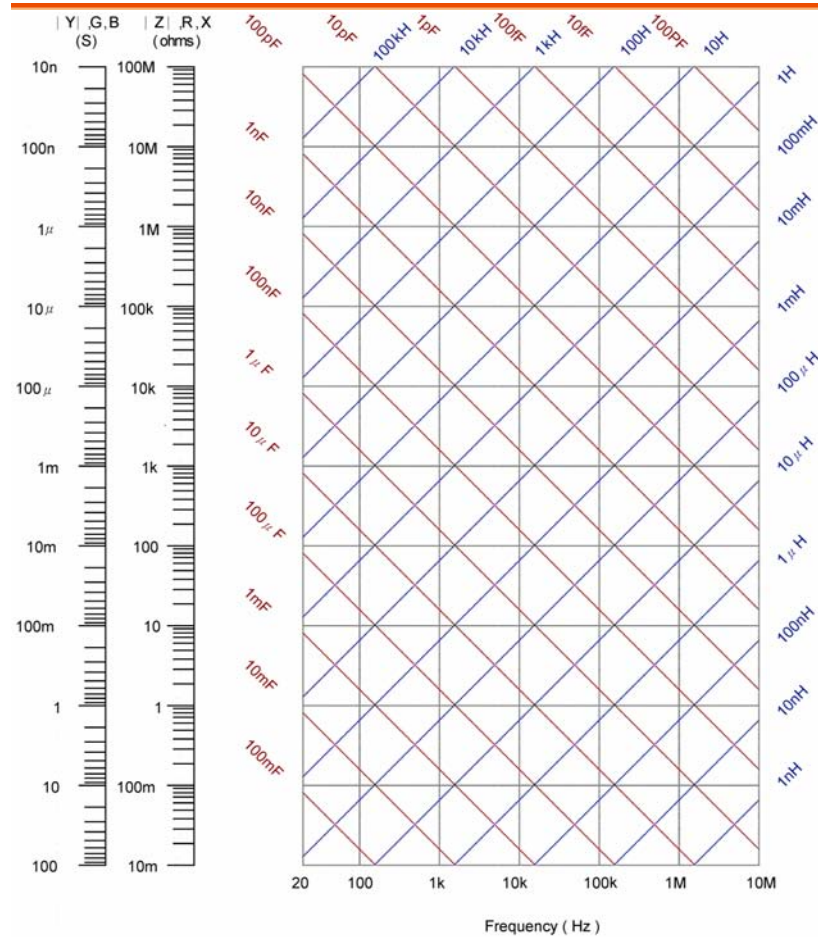

Conversion method:

CF → |Z|

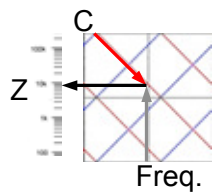

LF → |Z|

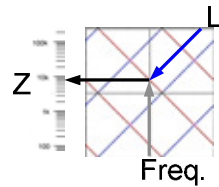

Accuracy Definition

 Z , Y 	High Impedance $Ae[\%] = \pm ((A + 0.0000001 * Z_x) * K_v * K_t)$ Low Impedance $Ae[\%] = \pm ((A + 0.1 / Z_x) * K_v * K_t)$																																																																						
L, C, X, B	High Impedance when $D < 0.1$ $Ae[\%] = \pm ((A + 0.0000001 * Z_x) * K_v * K_t)$ High Impedance when $D \geq 0.1$ $Ae[\%] = \pm (((A + 0.0000001 * Z_x) * K_v * K_t) * \sqrt{1 + D^2})$ Low Impedance when $D < 0.1$ $Ae[\%] = \pm ((A + 0.1 / Z_x) * K_v * K_t)$ Low Impedance when $D \geq 0.1$ $Ae[\%] = \pm (((A + 0.1 / Z_x) * K_v * K_t) * \sqrt{1 + D^2})$																																																																						
R, G	High Impedance when $Q_x < 0.1$ $Ae[\%] = \pm ((A + 0.0000001 * Z_x) * K_v * K_t)$ High Impedance when $Q_x \geq 0.1$ $Ae[\%] = \pm (((A + 0.0000001 * Z_x) * K_v * K_t) * \sqrt{1 + Q^2})$ Low Impedance when $Q_x < 0.1$ $Ae[\%] = \pm ((A + 0.1 / Z_x) * K_v * K_t)$ Low Impedance when $Q_x \geq 0.1$ $Ae[\%] = \pm (((A + 0.1 / Z_x) * K_v * K_t) * \sqrt{1 + Q^2})$																																																																						
D	$\pm (Ae/100)$ when $D \leq 0.1$ $\pm ((Ae/100) * (1 + D^2))$ when $D > 0.1$																																																																						
Q	$\pm (((Q_x^2 * De) / (1 \pm Q_x * De))$ when $(Q_x * De) < 1$																																																																						
Θ	$\pm ((180 * Z Ae[\%]) / (\pi / 100))$																																																																						
Convention	<table border="0"> <tr> <td>A</td> <td colspan="4">Accuracy taken from the Accuracy chart</td> </tr> <tr> <td>Z_x</td> <td colspan="4">Measured value of unknown component</td> </tr> <tr> <td>K_v</td> <td colspan="4">Test Voltage factor</td> </tr> <tr> <td></td> <td>Level</td> <td>K_v</td> <td>Level</td> <td>K_v</td> </tr> <tr> <td></td> <td>≥ 1.250</td> <td>1.2</td> <td>≥ 0.078</td> <td>2</td> </tr> <tr> <td></td> <td>≥ 0.625</td> <td>1</td> <td>≥ 0.039</td> <td>2.5</td> </tr> <tr> <td></td> <td>≥ 0.313</td> <td>1.2</td> <td>≥ 0.02</td> <td>5</td> </tr> <tr> <td></td> <td>≥ 0.156</td> <td>1.5</td> <td>≥ 0.010</td> <td>10</td> </tr> <tr> <td>K_t</td> <td colspan="4">Temperature factor</td> </tr> <tr> <td></td> <td>Temperature</td> <td>K_t</td> <td>Temperature</td> <td>K_t</td> </tr> <tr> <td></td> <td>8-18°C</td> <td>2</td> <td>28-35°C</td> <td>2</td> </tr> <tr> <td></td> <td>18-28°C</td> <td>1</td> <td></td> <td></td> </tr> <tr> <td>Q_x</td> <td colspan="4">Measured Q value</td> </tr> <tr> <td>De</td> <td colspan="4">Relative D accuracy</td> </tr> </table>	A	Accuracy taken from the Accuracy chart				Z _x	Measured value of unknown component				K _v	Test Voltage factor					Level	K _v	Level	K _v		≥ 1.250	1.2	≥ 0.078	2		≥ 0.625	1	≥ 0.039	2.5		≥ 0.313	1.2	≥ 0.02	5		≥ 0.156	1.5	≥ 0.010	10	K _t	Temperature factor					Temperature	K _t	Temperature	K _t		8-18°C	2	28-35°C	2		18-28°C	1			Q _x	Measured Q value				De	Relative D accuracy			
A	Accuracy taken from the Accuracy chart																																																																						
Z _x	Measured value of unknown component																																																																						
K _v	Test Voltage factor																																																																						
	Level	K _v	Level	K _v																																																																			
	≥ 1.250	1.2	≥ 0.078	2																																																																			
	≥ 0.625	1	≥ 0.039	2.5																																																																			
	≥ 0.313	1.2	≥ 0.02	5																																																																			
	≥ 0.156	1.5	≥ 0.010	10																																																																			
K _t	Temperature factor																																																																						
	Temperature	K _t	Temperature	K _t																																																																			
	8-18°C	2	28-35°C	2																																																																			
	18-28°C	1																																																																					
Q _x	Measured Q value																																																																						
De	Relative D accuracy																																																																						

Specification

Test Frequency	LCR-8101G	DC, AC:20Hz~1MHz
	LCR-8105G	DC, AC:20Hz~5MHz
	LCR-8110G	DC, AC:20Hz~10MHz
Basic Accuracy	R,Z,X,G,Y,B,L,C	±0.1%@1kHz
R&G Accuracy	When $Qx \geq 0.1$, multiply Ae by $\sqrt{(1+Q^2)}$ for R, G accuracies.	
Measurable Parameters	Rac, Rdc, Rs, Rp, Z, Ls, Lp, D, G, B, θ , Cp, Cs, Q, Y, X	
Measurement Range	R,Z,X	0.1m Ω ~100M Ω
	G, Y, B	10ns~1ks
	L	0.1nH~100kH
	C	0.01pF~1F
	D	0.00001~1000
	Q	0.01~9999.9
	Rdc	0.01m Ω ~100M Ω
	Θ	-180°~+180°
Equivalent Circuit	Parallel	C+G, L+G, B+G, B+Q, B+D, B+R
	Series	X+R, X+D, X+Q
	Series & Parallel	C+R, C+D, C+Q, L+R, L+D, L+Q
Polar Form	Z + Phase Angle, Y + Phase Angle	
Input Impedance	100 Ω	
Measurement Speed	DC	Max:30ms; Fast:60ms; Medium:120ms; Slow:900ms
	AC \leq 100Hz	Max:600ms; Fast:650ms; Medium:1.2s; Slow:1.3s
	AC \leq 2kHz	Max:120ms; Fast:180ms; Medium:470ms; Slow:600ms
	AC $>$ 2kHz	Max:75ms; Fast:150ms; Medium:450ms; Slow:600ms
	AC=1MHz (LCR-8101G)	Max:120ms; Fast:150ms; Medium:470ms; Slow:620ms
	AC \geq 1~5MHz (LCR-8105G)	Max:120ms; Fast:150ms; Medium:470ms; Slow:620ms

	AC \geq 1~10MHz (LCR-8110G)	Max:120ms; Fast:150ms; Medium:470ms; Slow:620ms
Drive Signal Level	LCR-8101G	DC:0.01V~2V AC: 20Hz~1MHz: 0.01V~2Vrms
	LCR-8105G	DC:0.01V~2V AC 20Hz~ \leq 3MHz:0.01V~2Vrms AC $>$ 3MHz~5MHz:0.01V~1Vrms
	LCR-8110G	DC:0.01V~2V AC 20Hz~ \leq 3MHz:0.01V~2Vrms AC $>$ 3MHz~10MHz:0.01V~1Vrms
Drive Signal Short Circuit Current	LCR-8101G	DC:100uA~20mA AC 20Hz~1MHz:100uA~20mA rms
	LCR-8105G	DC:100uA~20mA AC:20Hz~ \leq 3MHz:100uA~20mArms AC $>$ 3MHz~5MHz:100uA~10mA rms
	LCR-8110G	DC:100uA~20mA AC:20Hz~ \leq 3MHz:100uA~20mArms AC $>$ 3MHz~10MHz:100uA~10mA rms
Drive Signal Resolution	When the drive signal level is $<$ 1V: 1mV When the drive signal level is \geq 1V: 10mV	
Drive Signal Open Circuit Accuracy	LCR-8101G	DC:± 2% ± 5mV AC20Hz~1MHz:± 2% ± 5mV
	LCR-8105G	DC: ± 2% ± 5mV AC:20Hz~ \leq 1MHz:± 2% ± 5mV AC: $>$ 1MHz~5MHz:± 5% ± 10mV
	LCR-8110G	DC: ± 2% ± 5mV AC:20Hz~ \leq 1MHz:± 2% ± 5mV AC: $>$ 1MHz~10MHz:± 5%±10mV

AC Drive Signal Frequency Accuracy	5 Digits, ±0.005%
LCD Display	320×240 Dot Matrix
Interface	RS-232, GPIB
GPIB Address	0~30 inclusive
Dimensions	330 (W) × 170 (H) × 340 (D), Unit: mm
Weight	Approx. 5kg
Power Source	AC 115V (+10% / -25%), AC 230V (+15% / -14%) (Selectable), 50/60Hz.
Multi Step	30 Steps
Operating Environment	Relative humidity <80% Altitude <2000 meters Temperature 0°C~40°C Pollution Degree 2
Storage Environment	Location Indoor Relative humidity <80% Temperature -40°C~70°C

Fixture Specifications

	LCR-09	LCR-12	LCR-13
Type	SMD/chip test fixture	Kelvin clip test leads (4 Wire)+ ground clip	SMD/chip test fixture
Frequency	DC~10MHz		
Max voltage	+/- 35 V		
Size range (SMD/chip)	0603~1812	N/A	0201~0805

	LCR-06A	LCR-05	LCR-07	LCR-08
Type	Kelvin clip test leads (4 Wire)	Test fixture for axial and vertical lead components	2 wire test leads + ground	SMD/clip tweezers
Frequency	DC~1MHz			
Max voltage	+/- 35 V			

Declaration of Conformity

We

GOOD WILL INSTRUMENT CO., LTD.

(1) No. 7-1, Jhongsing Rd., Tucheng City, Taipei County, Taiwan

(2) No. 69, Lu San Road, Suzhou City (Xin Qu), Jiangsu Sheng, China

declare, that the below mentioned product

Type of Product: **High Precision LCR Meter**

Model Number: **LCR-8101G; LCR-8105G; LCR-8110G**

are herewith confirmed to comply with the requirements set out in the Council Directive on the Approximation of the Law of Member States relating to Electromagnetic Compatibility (2004/108/EC) and Low Voltage Directive (2006/95/EC).

For the evaluation regarding the Electromagnetic Compatibility and Low Voltage Directive, the following standards were applied:

© **EMC**

Electrical equipment for measurement, control and laboratory use-- EMC requirements (2004/108/EC)	
Harmonized Standard	EN 55024:1998+A1:2001+A2:2003
Conducted & Radiated Emission EN 55022 : 2006 Class B	Electrostatic Discharge IEC 61000-4-2: 2001
Current Harmonics EN 61000-3-2: 2006	Radiated Immunity IEC 61000-4-3: 2006
Voltage Fluctuations EN 61000-3-3: 1995+A1: 2001 +A2: 2005	Electrical Fast Transients IEC 61000-4-4: 2004
-----	Surge Immunity IEC 61000-4-5: 2005
-----	Conducted Susceptibility IEC 61000-4-6: 2006
-----	Power Frequency Magnetic Field IEC 61000-4-8: 2001
-----	Voltage Dip/ Interruption IEC 61000-4-11: 2004

© **Safety**

Low Voltage Equipment Directive 2006/95/EC	
Safety Requirements	IEC/EN 61010-1: 2001

INDEX

absolute mode.....	66	display	
accessories	13	faq	129
accuracy		overview	48
specification	137	dissipation factor	
admittance		accuracy definition	136
accuracy definition.....	136	overview	45
overview.....	44	drive signal	
angle overview.....	46	specification.....	138
auto measurement range.....	51	drive voltage/current, hide...57	
average setting.....	62, 73	EN61010	
basic measurement.....	36	declaration of conformity ..	140
configuration	50	measurement category	6
run.....	55	pollution degree.....	8
show/hide circuit model	49	environment	
show/hide scale.....	49	operation.....	7
tutorial	26	storage.....	8
beep setting	61	equivalent circuit	
faq.....	129	specification.....	137
in repetitive mode	57	equivalent circuits.....	14
calibration.....	123	fixture	
command set.....	117	calibration.....	125
capacitance		how to connect	25
accuracy definition.....	136	overview	24
measurement tip	34	specification.....	139
overview	41	fixure specification	139
series/parallel model.....	38	frequency setting	
caution symbol.....	5	basic measurement	52
circuit model overview	38	graph mode	91
cleaning the instrument.....	7	pass/fail mult mode.....	77
command set, list.....	112	pass/fail single mode.....	65
command syntax	111	front panel overview	16
conductance		fuse	
accuracy definition.....	136	replacing	130
overview.....	40	safety instruction	7
delta mode.....	68	GPIB configuration.....	109

graph mode.....	87	power supply	
configuration.....	88	frequency selection.....	23
run.....	103	socket overview.....	20
tutorial.....	32	power up sequence.....	22
ground symbol.....	5	program, multi step	
hide drive voltage/current...	57	copy step.....	79
horizontal scale setting.....	90	create new.....	74
impedance		delete program.....	86
accuracy chart.....	134	delete step.....	79
accuracy definition.....	136	edit.....	76
measurement tip.....	34	load.....	85
overview.....	44	run.....	80
inductance		save.....	83
accuracy definition.....	136	quality factor	
measurement tip.....	34	accuracy definition.....	136
overview.....	42	overview.....	45
series/parallel model.....	38	reactance	
linear/logarithmic scale.....	91	accuracy definition.....	136
list of features.....	12	overview.....	43
main menu overview.....	47	remote control.....	107
marker operation, graph.....	106	calibration command.....	117
measurement		command set.....	112
basic measurement.....	36	command syntax.....	111
command set.....	113	faq.....	129
graph mode.....	87	graph command.....	118
item and combination.....	13	interface configuration.....	108
theory of each item.....	38	measurement command.....	113
measurement range		multi-step command.....	115
specification.....	137	system command.....	112
measurement speed		repetitive mode	
specification.....	137	basic measurement.....	56
measurement tips.....	34	pass/fail single mode.....	64
model comparison.....	15	resistance	
nominal value setting.....	69	accuracy definition.....	136
O/C trimming.....	123	overview.....	40
package contents.....	13	series/parallel model.....	39
pass/fail test.....	58	RS-232C configuration.....	108
multi step mode.....	70	S/C trimming.....	123
multiple step tutorial.....	30	service contact point.....	129
multi-step command set.....	115	single mode	
single step mode.....	60	basic measurement.....	55
single step tutorial.....	28	pass/fail single mode.....	64
percentage mode.....	67	specification.....	137

speed setting		trimming.....	125
graph mode.....	101	UK power cord.....	9
step size setting, graph mode		unit keys overview.....	17
.....	102	vertical scale setting.....	94
susceptance		graph mode.....	105
accuracy definition.....	136	voltage setting	
overview.....	43	basic measurement.....	54
system command.....	112	graph mode.....	90
test frequency		pass/fail multi mode.....	77
specification.....	137	pass/fail single mode.....	65
tilt stand.....	21	warning symbol.....	5
trigger delay setting.....	78		