



CM3286

CM3286-01

HIOKI

Instruction Manual

AC CLAMP POWER METER

-  Safety Notes ▶ p.5
-  **When using for the first time**
 - Power Measurement ▶ p.29
 - Integrated Measurement ▶ p.40
 - Auto Hold ▶ p.48
-  Troubleshooting ▶ p.64



EN

May 2017 Edition 1
CM3286A961-00 17-05H



Contents

Introduction	1
Options (sold separately)	4
Safety Notes	5
Usage Notes	9
Part Names	15
Operation keys	16
■ Rotary switch.....	17
■ Power-on Option Table (buzzer sound, resetting the instrument to the factory settings, etc.)	18
Insert / Replace Batteries	20
Inspection Before Measurement	21
Screen / Basic Operation	22
■ Screen display	23
■ Switching the information shown on the measurement display.....	24

Connecting the Clamp and Clips	27
Current/Voltage Measurement (Frequency) [\tilde{V} / \tilde{A}].....	28
Power Measurement (Power/Power Factor).....	29
■ AC single-phase measurement (1P2W) [var VA W].....	29
■ AC single-phase measurement (1P3W) [var VA W].....	30
■ AC 3-phase measurement (3P3W, balanced) [3PW].....	31
■ AC 3-phase measurement (3P3W, unbalanced) [3PW].....	32
■ AC 3-phase measurement (3P4W, balanced) [3PW].....	34
■ AC 3-phase measurement (3P4W, unbalanced) [3PW].....	35
Phase Detection [Phase Detect].....	38
Single-phase Active Energy Measurement (Integrated Measurement) [Setting Wh].....	40
Single-phase Energy Meter Comparison Function [Setting Wh].....	42
■ Setting the desired meter constant.....	46
Manual Hold / Auto Hold	48
Switching Ranges.....	51
MAX/ MIN/ AVG.....	52

Backlight / Auto Power Save (APS)	55
Measurement Using the Clamp Adapter	56
Bluetooth® Communications (only for CM3286-01)	57
■ Installing the application software GENNECT Cross.....	58
■ Turning on the Bluetooth® function	59
■ Pairing the app with the CM3286-01	60
■ Making measurements with the Bluetooth® function	61
Repairs, Inspections, and Cleaning	62
Troubleshooting	64
Specifications	69
■ General Specifications	69
■ Input/Output/Measurement Specifications	71
■ External Interface (Bluetooth®) Specifications	74
■ Application Software Specifications	74
Accuracy Table	75
Equations	87

Contents

Introduction

Thank you for purchasing the Hioki CM3286/CM3286-01 AC Clamp Power Meter. To obtain maximum performance from the instrument over the long term, be sure to read this manual carefully and keep it handy for future reference.

This clamp power meter provides functionality for measuring AC current, voltage, power, and frequency as well as for detecting phase.

The CM3286-01 also provides Bluetooth® communications functionality, allowing measurement data to be monitored and logged from a smartphone or tablet.

The instrument screen displays the alphanumeric characters as follows.

A	B	C	D	E	F	G	H	I	J	K	L	M	N	O	P	Q	R	S	T	U	V	W	X	Y	Z
A	b	C	d	E	F	G	H	I	J	K	L	M	N	O	P	Q	R	S	T	U	V	W	X	Y	Z

1	2	3	4	5	6	7	8	9	0
1	2	3	4	5	6	7	8	9	0

Introduction

Package contents

When you receive the instrument, inspect it carefully to ensure that no damage occurred during shipping. In particular, check the accessories, panel switches, and connectors. If damage is evident, or if it fails to operate according to the specifications, contact your authorized Hioki distributor or reseller.

- Model CM3286 or CM3286-01
AC Clamp Power Meter

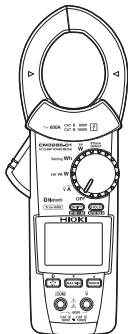

Accessories

- Model L9257 Connection Cord
(Model L4930 Connection Cable Set (1.2 m)
+ Model L4935 Alligator Clip Set)
CAT IV 600 V/ CAT III 1000 V/ CAT II 1000 V

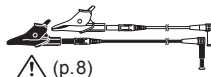

- Model C0203 Carrying Case



- LR03 Alkaline battery ×2



- Instruction Manual



- Precautions Concerning Use of Equipment
That Emits Radio Waves
(only for the CM3286-01)



Precautions during shipment

Handle it carefully so that it is not damaged due to a vibration or shock.

Trademarks

- Bluetooth® is a registered trademark of Bluetooth SIG, Inc.(USA). The trademark is used by HIOKI E.E. CORPORATION under license.
- Android and Google Play are trademarks of Google, Inc.
- IOS is a registered trademark of Cisco in the U.S. and other countries.
- iPhone, iPad, iPad mini, iPad Pro, and iPod Touch are trademarks of Apple Inc.

Accuracy

We define measurement tolerances in terms of f.s. (fullscale), rdg. (reading), and dgt. (digit) values, with the following meanings:

f.s. (maximum display value or range)	The maximum displayable value. This is usually the name of the currently selected range.
rdg. (displayed value)	The value currently being measured and indicated on the measuring instrument.
dgt. (resolution)	The smallest displayable unit on a digital measuring instrument, i.e., the input value that causes the digital display to show a "1" as the least-significant digit.

Options (sold separately)

Options (sold separately)

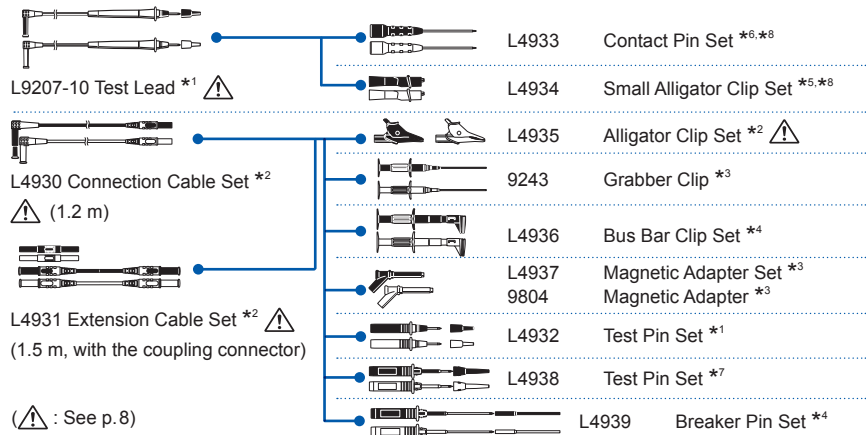

*1: CAT IV 600 V/ CAT III 1000 V/ CAT II 1000 V

*2: CAT IV 600 V/ CAT III 1000 V

*3: CAT III 1000 V

*4: CAT III 600 V

*5: CAT III 300 V/ CAT II 600 V

*6: 33 V AC/ 70 V DC

*7: CAT III 600 V/ CAT II 600 V

*8: Can also be connected to the tip of the L4932.



9290-10
Clamp On Adapter *4

Safety Notes

This instrument is designed to conform to IEC 61010 Safety Standards, and has been thoroughly tested for safety prior to shipment. However, using the instrument in a way not described in this manual may negate the provided safety features.

Before using the instrument, be certain to carefully read the following safety notes.

DANGER



Mishandling during use could result in injury or death, as well as damage to the instrument. Be certain that you understand the instructions and precautions in the manual before use.

WARNING



With regard to the electricity supply, there are risks of an electric shock, a heat generation, a fire, and an arc flash due to short-circuit. Individuals using an electrical measuring instrument for the first time should be supervised by a technician who has experience in electrical measurement.

 **WARNING**







Protective gear











This instrument is measured on a live line. To prevent an electric shock, use appropriate protective insulation and adhere to applicable laws and regulations.

Notation

In this document, the risk seriousness and the hazard levels are classified as follows.

 DANGER	Indicates an imminently hazardous situation that will result in death or serious injury to the operator.	IMPORTANT	Indicates information related to the operation of the instrument or maintenance tasks with which the operators must be fully familiar.
 WARNING	Indicates a potentially hazardous situation that may result in death or serious injury to the operator.		Indicates prohibited actions.
 CAUTION	Indicates a potentially hazardous situation that may result in minor or moderate injury to the operator or damage to the instrument or malfunction.		Indicates the action which must be performed.

Symbols affixed to the instrument

 <p>Indicates cautions and hazards. When the symbol is printed on the instrument, refer to a corresponding topic in the Instruction Manual.</p>	 <p>Indicates AC (Alternating Current).</p>
 <p>Indicates that dangerous voltage may be present at this terminal.</p>	 <p>Indicates DC (Direct Current).</p>
 <p>Indicates that the instrument may be connected to or disconnected from a live conductor.</p>	 <p>Indicates a grounding terminal.</p>
 <p>Indicates a instrument that has been protected throughout by double insulation or reinforced insulation.</p>	 <p>Indicates the Waste Electrical and Electronic Equipment Directive (WEEE Directive) in EU member states.</p>
 <p>Indicates that the product incorporates Bluetooth® wireless technology.</p>	 <p>Indicates that the product conforms to regulations set out by the EU Directive.</p>
<p>FCC ID</p> <p>Indicates the ID number of the wireless module certified by the U.S. Federal Communications Commission (FCC).</p>	<p>IC</p> <p>Indicates the identification number of a wireless module approved by Industry Canada (IC).</p>

Measurement categories

 **DANGER**



To prevent an electric shock, do not exceed the lower of the ratings shown on the instrument and connecting cords.

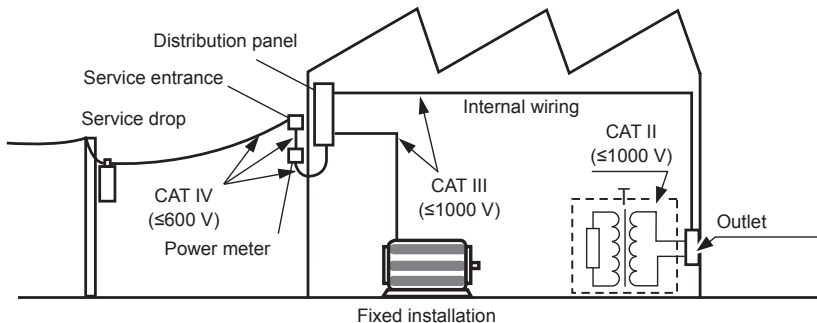

Usage Notes

Follow these precautions to ensure safe operation and to obtain the full benefits of the various functions.

DANGER



- Do not use the instrument with circuits that exceed its ratings or specifications. Doing so may damage the instrument or cause it to become hot, resulting in bodily injury.
- The instrument must not be used to measure current in high-voltage lines (1000 V or more). Attempting to do so could cause a short-circuit or accident resulting in injury or death. Also, do not perform measurement around a bare conductor.
- To prevent an electric shock, do not touch any areas beyond the barrier while the instrument is in use.

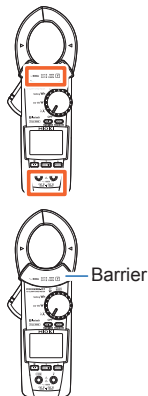

 **DANGER**



- Do not short-circuit two wires to be measured by bringing the clip or jaw tip of the connecting cords into contact with them. Arcs or such grave accidents are likely to occur.
- To prevent an electric shock, be careful to avoid shorting live lines with the connecting cords tip.
- To prevent a short-circuit or an electric shock, do not touch the metal part of the connecting cords tip.
- The maximum measurement current varies with the frequency, and the current that can be measured continuously is limited. Operating the instrument at less than this limitation is referred to as derating. Do not measure currents in excess of the derating curve. Doing so may result in instrument damage or malfunction, a fire, or a burn due to sensor heating.



- It is recommended to make measurements on the secondary side of the distribution panel. Making measurements on the primary side of the panel, where currents are higher, poses a higher risk of instrument or equipment damage in the event of a short-circuit.

 **WARNING**

- Installing the instrument in inappropriate locations may cause a malfunction of instrument or may give rise to an accident. Avoid the following locations.
 - Exposed to direct sunlight or high temperature
 - Exposed to corrosive or combustible gases
 - Exposed to a strong electromagnetic field or electrostatic charge
 - Near induction heating systems (such as high-frequency induction heating systems and IH cooking equipment)
 - Susceptible to vibration
 - Exposed to water, oil, chemicals, or solvents
 - Exposed to high humidity or condensation
 - Exposed to high quantities of dust particles
 - Although this instrument is designed to resist the ingress of dust and dripping water, it is not entirely waterproof or dustproof. Therefore, to prevent an electric shock, do not use it in a wet or dusty environment.
 - Battery may explode if mistreated. Do not short-circuit, recharge, disassemble or dispose of in fire.
-

 **WARNING**



- **Use only the specified connection cords. Use of any connection cord not specified by our company does not allow safe measurements.**
- **To prevent an electric shock, set the rotary switch to the OFF position, disconnect all connection cords, and remove the instrument from the measurement object before replacing the batteries.**
- **To prevent instrument damage or an electric shock, use only the screw for securing the battery cover in place that is originally installed. If you have lost a screw or find that a screw is damaged, please contact your authorized Hioki distributor or reseller for replacement.**
- **Options may include connection cords which uses sleeves. To prevent a short-circuit accident, be sure to use the connection cords with the sleeves attached when performing measurements in the CAT III or CAT IV measurement categories. (See "Measurement categories" (p. 8))**
- **If the sleeves are inadvertently removed during measurement, stop the measurement.**

 **CAUTION**

- To avoid damage to the instrument, protect it from physical shock when transporting and handling it. Be especially careful to avoid physical shock due to dropping it.
- Do not place foreign objects between jaws or insert foreign objects into the gaps of the sensor head. Doing so may worsen the performances of the sensor or interfere with clamping action.



- Poor performance or damage from battery leakage could result. Observe the cautions listed below.
 - Do not mix old and new batteries, or different types of batteries.
 - Be careful to observe the battery polarity during installation.
 - Do not use batteries after their recommended expiry date.
 - Do not leave depleted batteries inside the instrument.
 - Replace batteries only with the specified type.
- Keep the jaw closed when not in use, to avoid accumulating dust or dirt on the facing core surfaces, which could interfere with clamp performance.
- The cord is hardened in freezing temperature. Do not bend or pull it to avoid tearing its shield or cutting cord.

IMPORTANT

Inverter secondary-side waveforms and waveforms that include a large noise component may not be measured accurately.

Current measurement precautions

Do not touch.



**Do not clamp
around two wires.**



**Do not pinch wire
between jaws.**

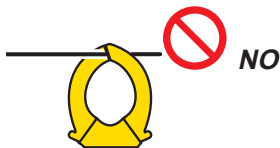

**Do not input
excessively high
currents or voltages.**



Part Names

Front

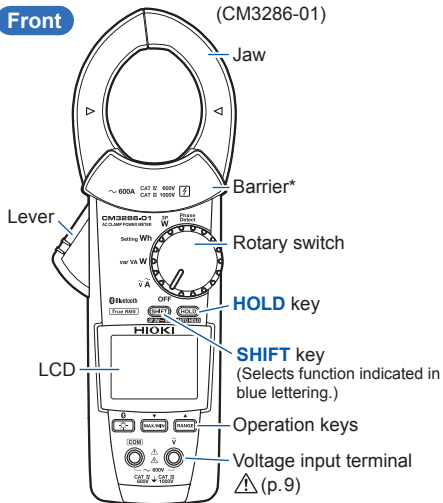

Rear

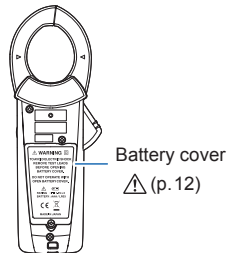



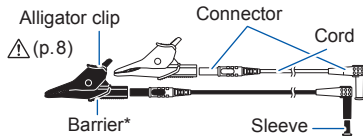





L9257 Connection Cord



* Do not touch any areas beyond the barrier while the instrument is in use.

Operation keys

Key	Short press		Long press (1 sec.)	
 HOLD 	Activates/cancels manual hold operation	p.48	Activates/cancels automatic hold operation	p.48
	Start/stop integration, clears the integrated energy value (during energy measurement)	p.41		
	Switches the setting (when setting meter constants)	p.46		
	Switches from the connection display to the measurement display (during 3-phase power measurement)	p.22		
 SHIFT 	Switches the information shown on the measurement display	p.24	Switches between 3-phase/3-wire and 3-phase/4-wire measurement during 3-phase power measurement (setting is not stored)	p.34 p.35
 RANGE 	Switches ranges	p.51	High speed count up (when setting meter constants)	-
	Count up (when setting meter constants)	p.46		
 MAX/MIN 	Displays and switches MAX/MIN/AVG value	p.52	Cancels the display of MAX/MIN/AVG value	p.52
	Count down (when setting meter constants)	p.46	High speed count down (when setting meter constants)	-
	Toggles the display backlight on and off	p.55	Enables/disables external communications (Bluetooth®) (only for CM3286-01, setting is stored)	p.59

Rotary switch

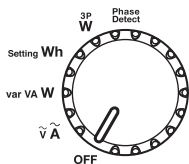

















When functions other than **OFF** is selected, the instrument turns on.
Select the desired function.

Phase Detect	"Phase Detection [Phase Detect]" (p. 38)
3P W	<ul style="list-style-type: none"> "AC 3-phase measurement (3P3W, balanced) [3PW]" (p. 31) "AC 3-phase measurement (3P3W, unbalanced) [3PW]" (p. 32) "AC 3-phase measurement (3P4W, balanced) [3PW]" (p. 34) "AC 3-phase measurement (3P4W, unbalanced) [3PW]" (p. 35)
Setting Wh	<ul style="list-style-type: none"> "Single-phase Active Energy Measurement (Integrated Measurement) [Setting Wh]" (p. 40) "Single-phase Energy Meter Comparison Function [Setting Wh]" (p. 42)
var VA W	<ul style="list-style-type: none"> "AC single-phase measurement (1P2W) [var VA W]" (p. 29) "AC single-phase measurement (1P3W) [var VA W]" (p. 30)
$\tilde{v} \tilde{A}$	"Current/Voltage Measurement (Frequency) [$\tilde{v} \tilde{A}$]" (p.28)
OFF	Turns off the instrument.





Power-on Option Table (buzzer sound, resetting the instrument to the factory settings, etc.)

+  Turn on the power while pressing the operation key.
(Turn the rotary switch from OFF.)

Setting	See	Operating instruction	Factory setting	Setting retained?
Switching the auto power save (APS) function (p.55)	-	 + 	ON	-
Displaying product information or displaying all indicators (Display varies depending on the position of the rotary switch.)	-	 +  3PW: Serial number Wh: Model number W: Version of software Besides the above: Displays all indicators	-	-
Switching between balanced and unbalanced operation (during AC 3-phase power measurement)	p.32 p.35	 +  ^{3PW}	-	-
Buzzer sound (ON/OFF)	-	 + 	ON	Yes
Switching the auto backlight off function (p.55)	-	 + 	ON	Yes

Setting	See	Operating instruction	Factory setting	Setting retained?
Selecting the CT ratio	p.56	 +  + 	1/1	Yes
Reset to the factory setting	-	 +  + 	-	-

Insert / Replace Batteries

	Fully charged.
	As the battery charge diminishes, black charge bars disappear, one by one, from the left of the battery indicator.
	The battery voltage is low. Replace the batteries as soon as possible. The instrument may lose power when the backlight turns on, when a buzzer sounds, etc.
 (Flashes)	The battery is exhausted. Replace with new batteries.

Required items: No. 2 Phillips screwdriver and LR03 Alkaline battery ×2

Recommended screw tightening torque: 0.7 N·m

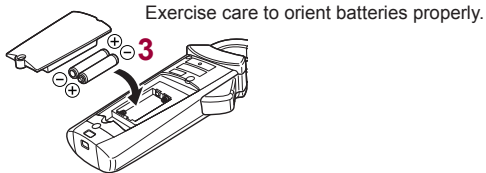
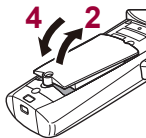
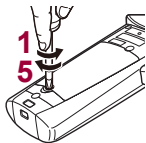

Inspection Before Measurement

Verify that the instrument operates normally to ensure that no damage occurred during storage or shipping. If you find any damage, contact your authorized Hioki distributor or reseller.

Check item	
<input type="checkbox"/> The battery cover is closed and its screw has been securely tightened.	<input type="checkbox"/> There is no damage to the connection cords insulation, and neither the white sheathing nor metal conductor inside the wire are exposed.
<input type="checkbox"/> There is no foreign matter on the voltage input terminals. (p. 15)	<input type="checkbox"/> The instrument is neither damaged nor cracked.
<input type="checkbox"/> The battery voltage (p.20) is sufficient.	<input type="checkbox"/> No indicators are missing.

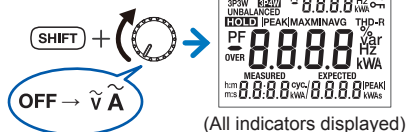

Screen / Basic Operation

Setting the rotary switch to a position other than **OFF** causes the instrument to turn on and the screen to activate. e.g.: During balanced 3-phase 3-wire active power measurement

Connection display

Displays the connection locations for 3-phase power measurement and phase detection. Connects the wire.

Wire around which to clamp instrument

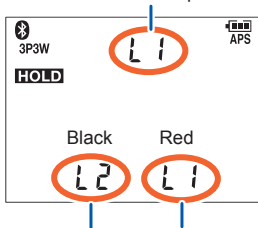

Wires to which to clip connection cords

Measurement display

Displays the measured value.

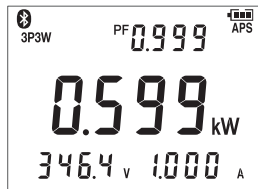

IMPORTANT

If measured with a wrong wire connection, a correct value does not appear.

Screen display

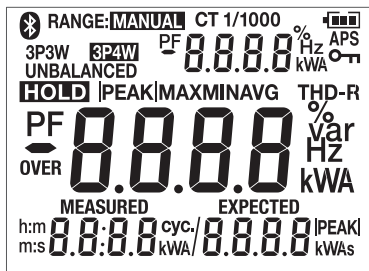

(All indicators displayed)

"Error display" (p. 66)

"Warning display" (p. 66)

*The key lock feature may be activated according to the usage state of the application software.

	Appearing: Bluetooth® communications function enabled Flashing: Bluetooth® communications active (only for CM3286-01)
3P3W, 3P4W	Connection type (not shown during single-phase measurement)
UNBALANCED	Unbalanced mode operation (not shown during balanced mode operation)
RANGE: MANUAL	Manual range operation (not shown during auto-range operation)
CT 1/1000	CT ratio (not shown during 1/1)
HOLD	Measured value held
APS	Auto power-off enabled
OVER	Current RMS value or voltage RMS value exceeded range
	Key lock enabled*

Switching the information shown on the measurement display

Able to switch using the **SHIFT** key (Excluding the Setting **Wh** and **Phase Detect** functions).

How to use this chart:

(Sub1 display)	
$FREQ_U$	
(Main display)	
I_{RMS}	
(Sub2 display)	(Sub3 display)
—	$I_{ PEAK }$

Rotary switch	Current ← SHIFT → Voltage	
	$FREQ_I$	$FREQ_U$
Current (frequency)	I_{RMS}	U_{RMS}
Voltage (frequency)	I_{RMS}	U_{RMS}
\tilde{v} \tilde{A}	— $I_{ PEAK }$	— $U_{ PEAK }$

$FREQ_I$: Current frequency

I_{RMS} : Current RMS value

$I_{|PEAK|}$: Current peak value

$FREQ_U$: Voltage frequency

U_{RMS} : Voltage RMS value

$U_{|PEAK|}$: Voltage peak value

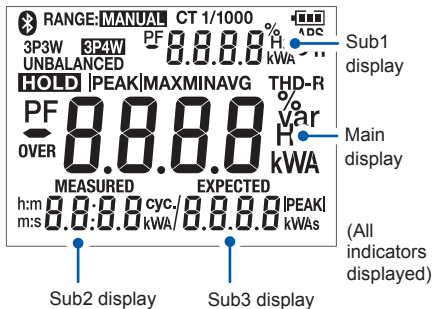

Rotary switch		Active power— Apparent power— Reactive power— Power factor— Zero-cross phase angle									
		(Main display)									
Voltage/Power factor var VA W	PF		PF		PF		P		P		
	P		S		Q		PF		ϕ		
	U_{RMS}	I_{RMS}	U_{RMS}	I_{RMS}	U_{RMS}	I_{RMS}	U_{RMS}	I_{RMS}	U_{RMS}	I_{RMS}	
3P W	Balance mode*1	PF^{*2}		PF^{*2}		PF^{*2}		P_{3P}		P_{3P}	
		P_{3P}		S_{3P}		Q_{3P}		PF_{3P}^{*2}		ϕ_{3P}^{*2}	
		U_{RMS}	I_{RMS}	U_{RMS}	I_{RMS}	U_{RMS}	I_{RMS}	U_{RMS}	I_{RMS}	U_{RMS}	I_{RMS}
	Unbalance mode*3	P_3		S_3		Q_3		PF_3		ϕ_3	
		$P_1+P_2+P_3$		$S_1+S_2+S_3$		$Q_1+Q_2+Q_3$		$\frac{P_1+P_2+P_3}{S_1+S_2+S_3}$		-	
		P_1	P_2	S_1	S_2	Q_1	Q_2	PF_1	PF_2	ϕ_1	ϕ_2

 P : Single-phase active power S : Single-phase apparent power Q : Single-phase reactive power PF : Power factor ϕ_1 : Zero-cross phase angle 1 P_1 : Active power 1 S_1 : Apparent power 1 Q_1 : Reactive power 1 PF_1 : Power factor 1 ϕ_2 : Zero-cross phase angle 2 P_2 : Active power 2 S_2 : Apparent power 2 Q_2 : Reactive power 2 PF_2 : Power factor 2 ϕ_3 : Zero-cross phase angle 3 P_3 : Active power 3 S_3 : Apparent power 3 Q_3 : Reactive power 3 PF_3 : Power factor 3

Screen / Basic Operation

P_{3p} : Balanced 3-phase active power

S_{3p} : Balanced 3-phase apparent power

Q_{3p} : Balanced 3-phase reactive power

PF_{3p} : Balanced 3-phase power factor

ϕ : Zero-cross phase angle

$P_1+P_2+P_3$: Unbalanced 3-phase active power

$S_1+S_2+S_3$: Unbalanced 3-phase apparent power

$Q_1+Q_2+Q_3$: Unbalanced 3-phase reactive power

$\frac{P_1+P_2+P_3}{S_1+S_2+S_3}$: Unbalanced 3-phase power factor

ϕ_{3p} : 3-phase zero-cross phase angle

Notes(*) for table

- *1 Value of the measured phase will be calculated and displayed.
- *2 Different calculation methods are used for 3-phase/3-wire and 3-phase/4-wire circuits. For more information, see the list of equations.
- *3 Only 3-phase active power (P_1+P_2), active power 1 (P_1), and active power 2 (P_2) are measured for 3-phase/3-wire circuits.

-	
P_1+P_2	
P_1	P_2

Connecting the Clamp and Clips

Clamp

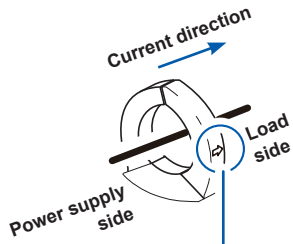

Align the current direction mark with the direction of the current.

Clip (Alligator)



Clip (Magnetic adapter)

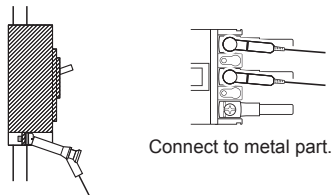

(If unable to connect the magnetic adapter so that it sits perpendicular to the terminal due to the weight of the voltage cord, connect it at an angle so as to balance it against the weight of the cord.)

Current/Voltage Measurement (Frequency) [\tilde{v} \tilde{A}]



Current measurement

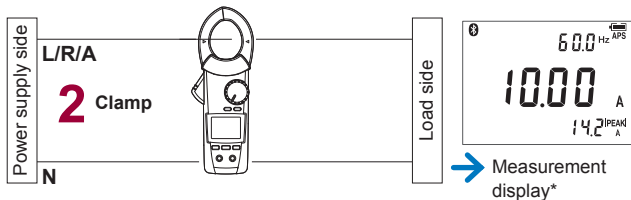

"Switching the information shown on the measurement display" (p. 24)

If the screen turns red:
"Warning display" (p. 66)

The frequency display flashes when frequency exceeds 999.9 Hz.

Voltage measurement

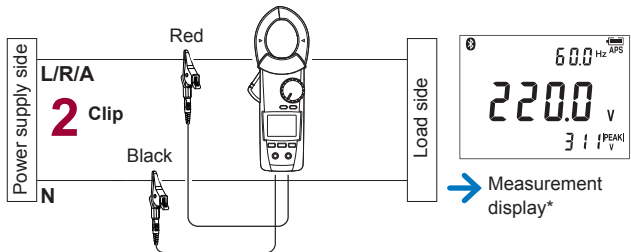

Power Measurement (Power/Power Factor)

AC single-phase measurement (1P2W) [var VA W]



"Switching the information shown on the measurement display" (p. 24)

If the screen turns red: "Warning display" (p. 66)

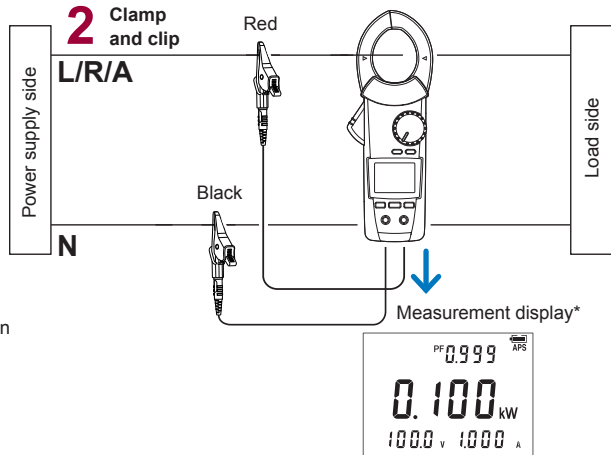

AC single-phase measurement (1P3W) [var VA W]

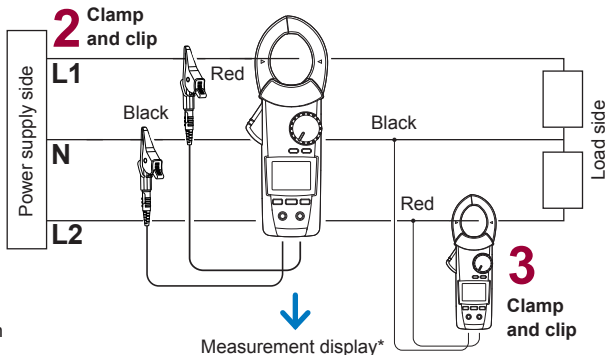

"Switching the information shown on the measurement display" (p. 24)

If the screen turns red: "Warning display" (p. 66)

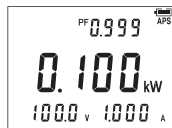

AC 3-phase measurement (3P3W, balanced) [3PW]



Connection display (p.22)

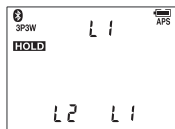

"Switching the information shown on the measurement display" (p. 24)

If the screen turns red: "Warning display" (p. 66)

When the balanced 3-phase 3-wire zero-cross phase angle is less than -90° or exceeds 90° , the measured value appears "-----".

2 Clamp and clip

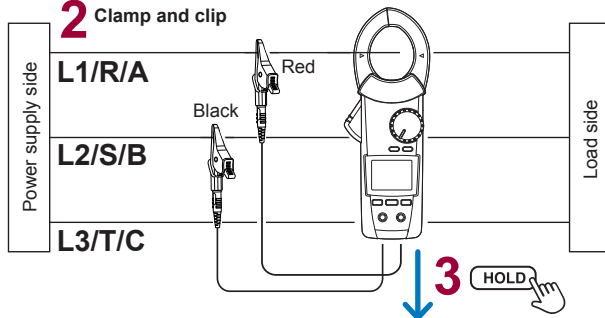

Measurement display (calculation result)*

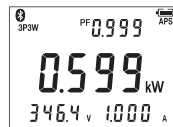

AC 3-phase measurement (3P3W, unbalanced) [3PW]

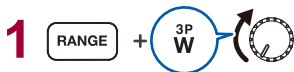

Connection display 1 (p.22)

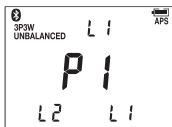

- Proceed to the next step after verifying that the measured values shown on measurement displays 1 and 2 are normal.
- If the screen turns red: "Warning display" (p. 66)

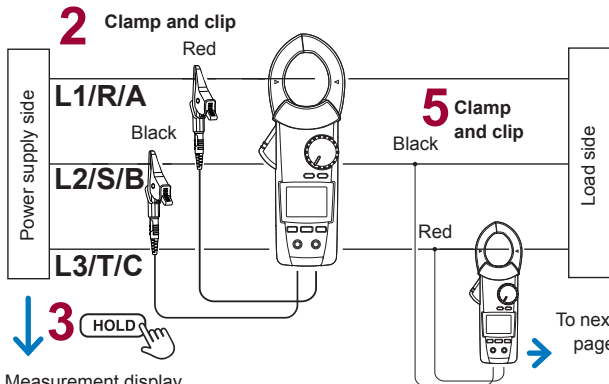

Measurement display (active power 1)

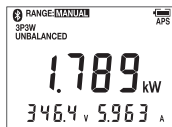

Connection display 2

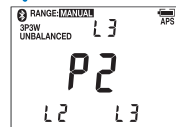

To next page

Power Measurement (Power/Power Factor)

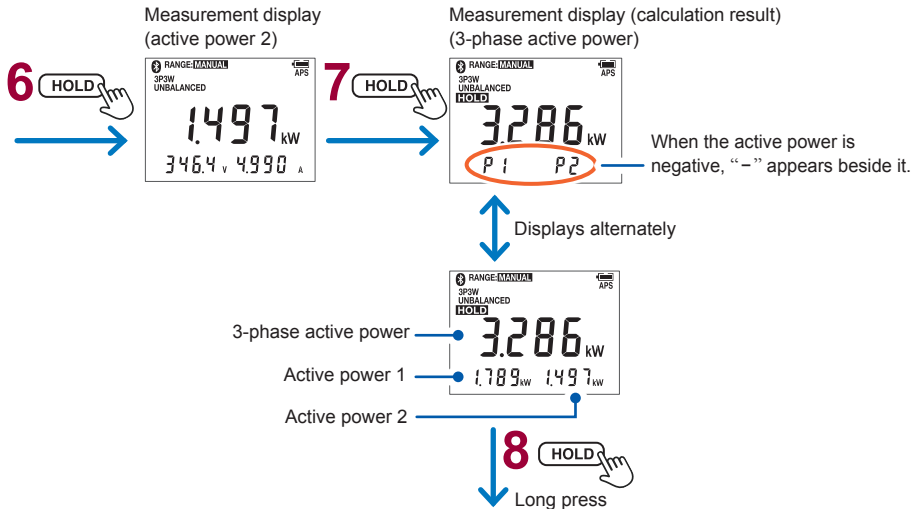

The measured value is cleared and returns to the initial connection display.

AC 3-phase measurement (3P4W, balanced) [3PW]



More than 1 sec.

Connection display (p.22)

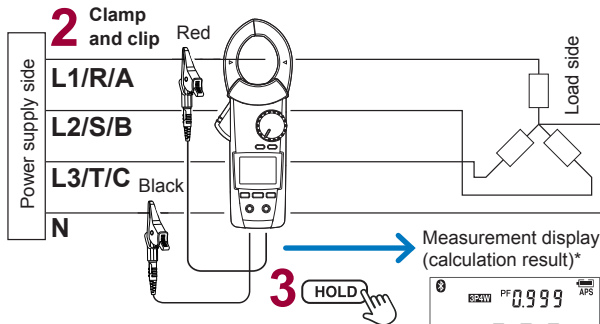
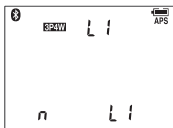

Measurement display (calculation result)*



If the screen turns red:
"Warning display" (p. 66)

*  "Switching the information shown on the measurement display" (p. 24)

AC 3-phase measurement (3P4W, unbalanced) [3PW]



More than 1 sec.

Connection display 1 (p.22)

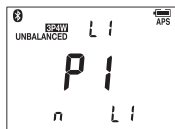

Proceed to the next step after verifying that the measured values shown on measurement display 1 is normal.

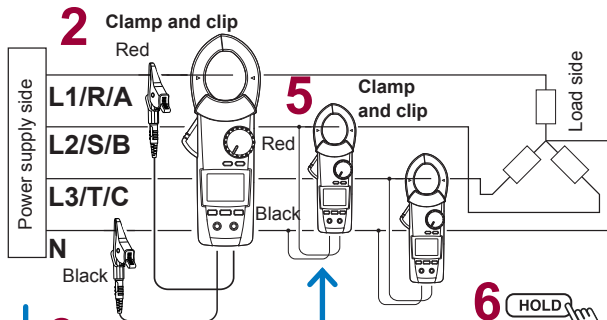

Measurement display 1 (active power 1)



Connection display 2

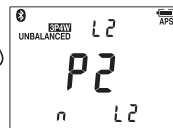

Power Measurement (Power/Power Factor)

Measurement display 2
(active power 2)

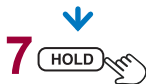
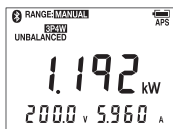

Connection display 3

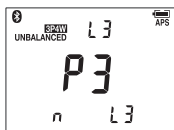

→ To 8

Proceed to the next step after verifying that the measured values shown on measurement display 2 and 3 are normal.

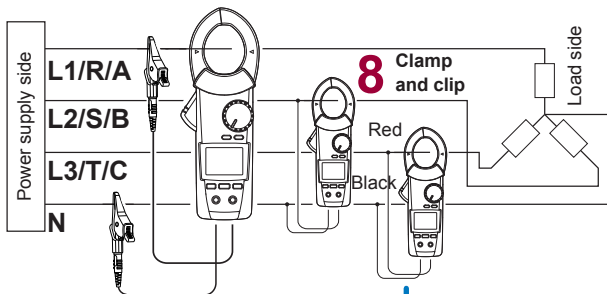

9 HOLD

Measurement display 3
(active power 3)

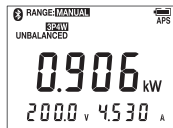

→ To next page

Power Measurement (Power/Power Factor)

Measurement display 4 (calculation result)
(3-phase active power)

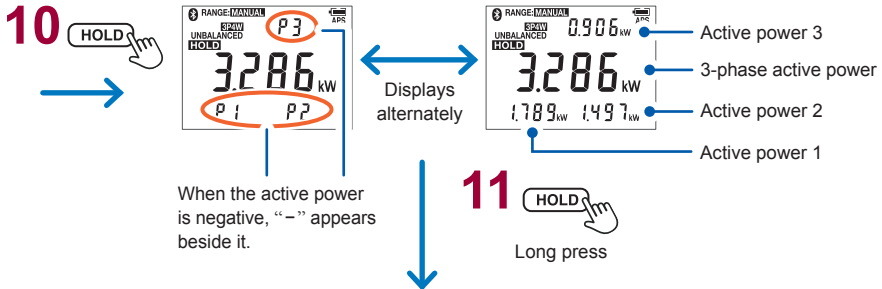

When the active power is negative, “-” appears beside it.

The measured value is cleared and returns to the initial connection display.

- You can switch the information shown on the final measurement display with the **SHIFT** key. See "Switching the information shown on the measurement display" (p. 24)
- If the screen turns red: "Warning display" (p. 66)

Phase Detection [Phase Detect]



Connection display (p. 22)

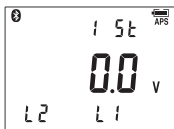

- The instrument will display "----" if open phase is detected or if it is unable to make a measurement.
- When the input is unstable, the second connection display will not show up.
- * If not clipped within 10 seconds, it is unable to make a measurement.

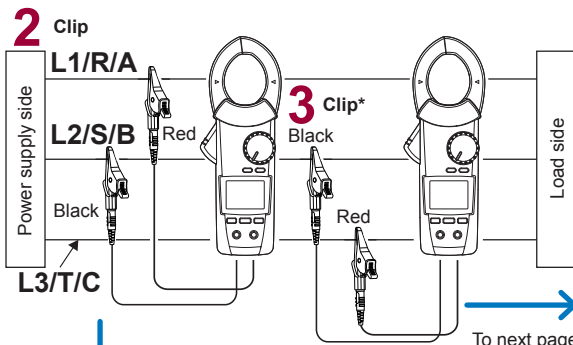

Measurement display



Line voltage (1st measurement)

Connection display



Countdown display

To next page

Phase Detection [Phase Detect]

Measurement display

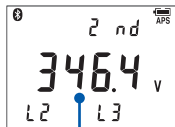

Line voltage (2nd measurement)



Normal phase

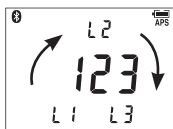

Reverse phase





(Lights red)

Display appears in the order of the arrow.

Goes back to the first display when the **HOLD** key is pressed.

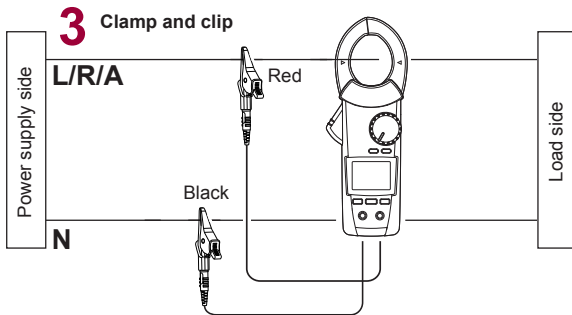
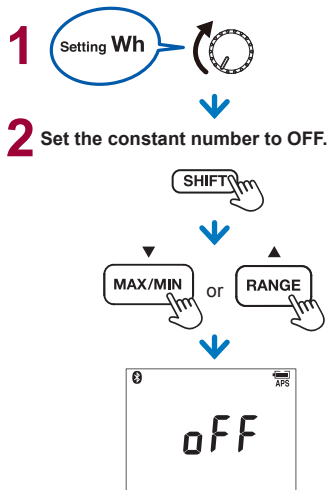
Single-phase Active Energy Measurement (Integrated Measurement) [Setting Wh]





To next page

Single-phase Active Energy Measurement (Integrated Measurement) [Setting Wh]

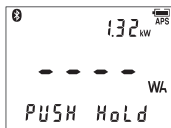
4 Set the instrument to power integration mode.

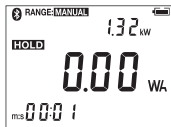

5 Start integration.



- Range is fixed when integration starts. Change the range before starting to integrate a large power quantity or for an extended period of time.
- Only the positive (consumption) active power is added. Negative (generation) active power is not added.

6 Stop integration.

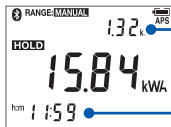

- Single-phase active power
- Single-phase active energy
- Elapsed time

- When the **HOLD** key is pressed during integration stop, the integrated energy clears and returns to the display shown in Step 4.
- The measured values are automatically stored just before the instrument turns off due to low battery voltage. Next time the instrument is turned on, the saved values will be displayed. (The measured values can be cleared by pressing the **HOLD** key.)

Single-phase Energy Meter Comparison Function [Setting Wh]

This function allows you to compare the actual energy value (measured value) from an energy meter with the theoretical value.

There are two ways to start and stop integration:

- Start/stop at 1 cycle based on the energy meter's instrument constant: 1-cycle mode
- Start/stop based on a fixed amount of energy as measured by the energy meter: Fixed energy mode

IMPORTANT

Energy may not be calculated properly in the following circumstances:

- If the power line of the measurement object, instrument connection, or meter constant (for the watt-hour meter) is set incorrectly.
- If integration is not started and stopped as described above.
- If the instrument is being used outside its operating temperature and humidity range.
- If the instrument is being used in close proximity to a device that emits powerful electromagnetic radiation or a device that carries an electrical charge.
- If the instrument is being used in close proximity to a device that emits a strong magnetic field, for example a transformer, high-current circuit, or wireless device.

1-cycle mode

Mechanical meter

Once the disc has completed one revolution

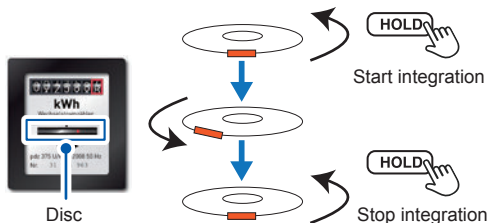

Electronic meter

When the LED flashes once

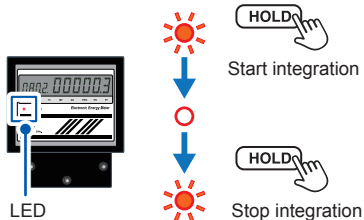

Fixed energy mode

e.g.: With the fixed energy set to 0.1 kWh

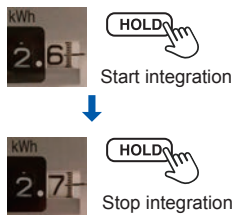
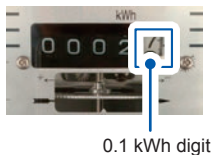

Single-phase Energy Meter Comparison Function [Setting Wh]

- 1** Setting Wh 
- 2** Select the constant number or fixed energy*.

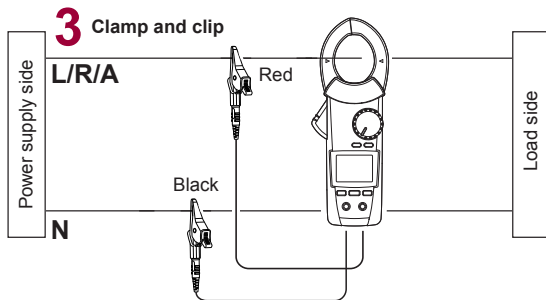
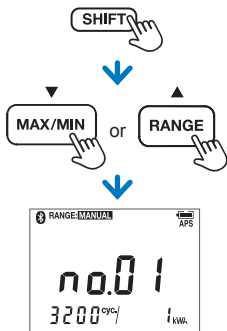

To next page

* Select fixed energy mode if the energy meter's disc rotates, or if its LED flashes, quickly.

The constant can be changed.
"Watt-hour meter constants default setting value" (p. 47)
"Setting the desired meter constant" (p. 46)

Single-phase Energy Meter Comparison Function [Setting Wh]

4 Set the instrument to power integration mode.



5 Start integration.



6 Stop integration.

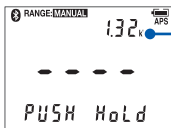

Single-phase active power (measured value)

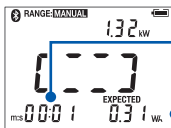

Elapsed time

Energy (theoretical value)

- Only the positive (consumption) active power is added. Negative (generation) active power is not added.
- Range is fixed when integration starts. Change the range before starting to integrate a large power quantity or for an extended period of time.

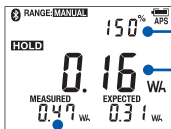

Energy ratio (Measured value/theoretical value)

Energy difference (Measured value – theoretical value)

Energy (Measured value)

When the **HOLD** key is pressed during integration stop, the integrated energy clears and returns to the display shown in Step 4.

Setting the desired meter constant

Set after conducting the procedures 1 and 2 of "Single-phase Energy Meter Comparison Function [Setting Wh]" (p. 42)

- 1** Select the portion you wish to change. The selected portion will flash.



- 2** Change the value.

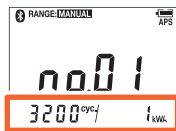

— Set the value shown on the meter.

The set value will be stored.

- Press the **SHIFT** key to go back to the measurement display.
- The changed final value will be the setting value.
- "Watt-hour meter constants default setting value" (p. 47)

Watt-hour meter constants default setting value

No.01 to No.10: 1-cycle mode

0.10 kWh to 0.01 kWh: Fixed energy mode

SET No.	Setting value	Changing the setting value Enable: ✓ Disable: –	SET No.	Setting value	Changing the setting value Enable: ✓ Disable: –
oFF	None (single-phase energy measurement)	✓	07	300 cyc./1 kWh	✓
01	3200 cyc./1 kWh	✓	08	250 cyc./1 kWh	✓
02	1600 cyc./1 kWh	✓	09	150 cyc./1 kWh	✓
03	1200 cyc./1 kWh	✓	10	125 cyc./1 kWh	✓
04	1000 cyc./1 kWh	✓	0.10 kWh	0.10 kWh	–
05	600 cyc./1 kWh	✓	0.05 kWh	0.05 kWh	–
06	500 cyc./1 kWh	✓	0.01 kWh	0.01 kWh	–

Updated settings are stored by the instrument.

Manual Hold / Auto Hold

MANUAL HOLD

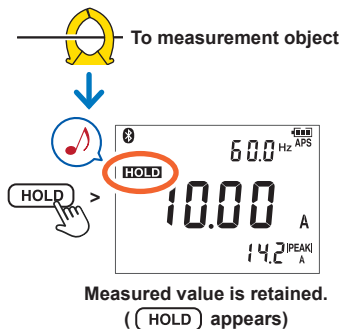

Pressing the **HOLD** key again cancels the measured value hold function.
(**HOLD** and HOLD disappears)

AUTO HOLD

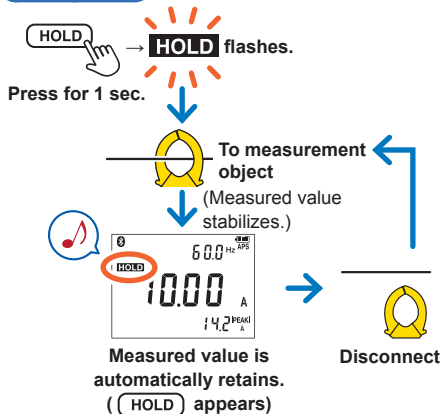

Pressing the **HOLD** key for 1 second cancels the auto hold function. (**HOLD** and HOLD disappears)

See the next page for auto hold conditions.

Auto hold conditions

Measured value is automatically retained when the following two conditions are satisfied:

- When the range over which the measured value is fluctuating stabilizes within the fluctuation range described in the table in the next page.
- When the measured value exceeds the threshold value described in the table in the next page.

O: Held value

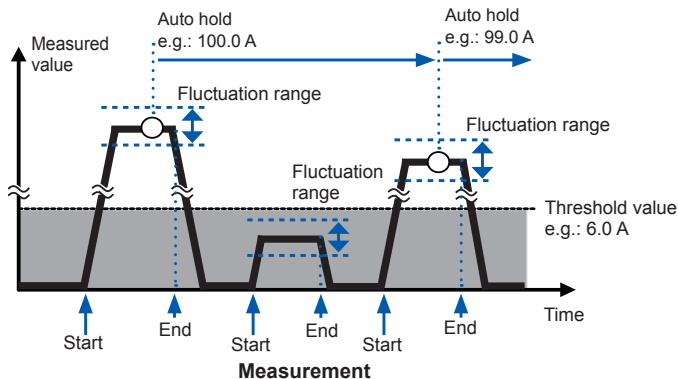

If the measured value* (voltage, current, or active power) falls below the threshold value once and the two conditions are satisfied again after automatic retaining, the measured value at that point will retain automatically.

* Either the current RMS value or voltage RMS value for power.

Manual Hold / Auto Hold

Measurement function*	Fluctuation range	Threshold value
AC current	Current RMS value 6.000 A range: within 60 counts 60.00 A range: within 60 counts 600.0 A range: within 60 counts	Current RMS value 6.000 A range: 59 counts 60.00 A range: 59 counts 600.0 A range: 59 counts
AC voltage	Voltage RMS value within 120 counts	Voltage RMS value 799 counts
Single-phase power, balanced 3-phase power	Current and voltage RMS values satisfy above conditions, and active power is within 5 counts.	Current and voltage RMS values are within the above counts.

* No auto-hold function is available for single-phase active energy measurement.

Switching Ranges

e.g.: During current measurement

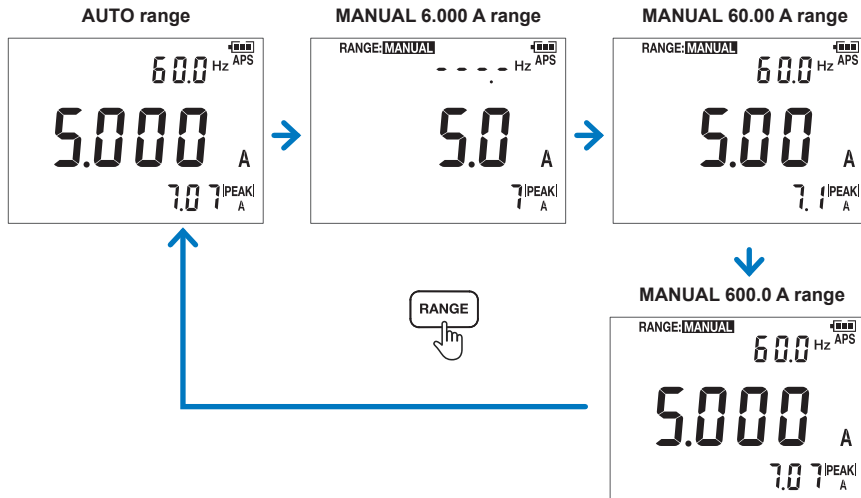



MAX/ MIN/ AVG

1  To measurement object

2  Present value → MAX → MIN → AVG



 : To switch the main display.

 (long press) or  (switching functions): MAX/MIN/AVG measurement function is cleared.

- Switches to manual range when it is auto range. (**RANGE:MANUAL** appears)
- The MAX/MIN/AVG measurement will be continued during hold function.
- The maximum, minimum, and average function cannot be used during Wh function and phase detect function operation.
- The maximum, minimum, and average values are automatically stored just before the instrument turns off due to low battery voltage. Next time the instrument is turned on, the saved values will be displayed. (The measured values can be cleared by pressing the **HOLD** key.)

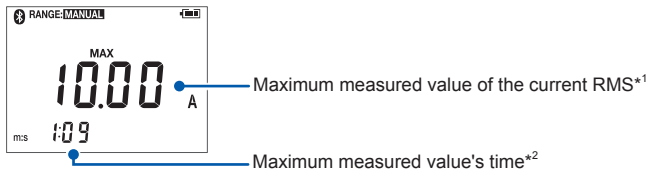
e.g.: During current measurement

*1 The maximum, minimum, and average values for the main display's measured value is shown.

(However, only the maximum and average values are shown during peak value measurement.

Also, only the maximum and minimum values are shown during zero-cross phase angle measurement.)

*2 Measured value's update time is displayed when maximum or minimum value is shown. Elapsed time from the start of maximum, minimum, and average function is displayed when present or average value is shown.

MAX/ MIN/ AVG

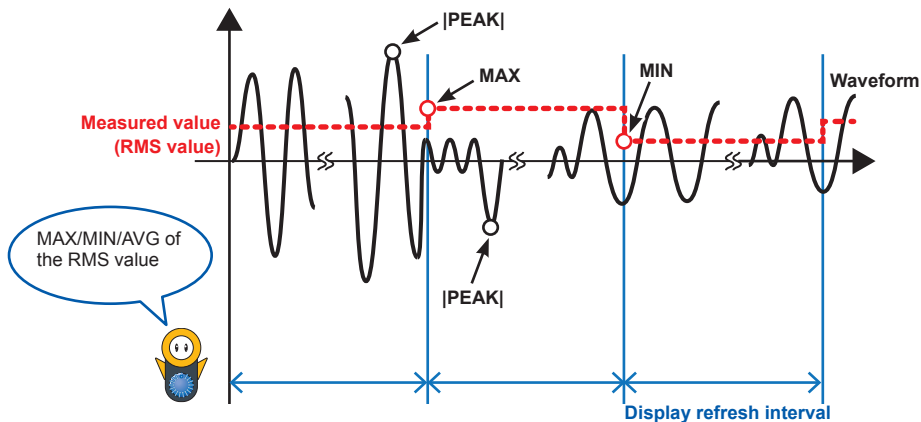

AVG: Average value after pressing the **MAX/MIN** key

MAX: Maximum value after pressing the **MAX/MIN** key

MIN: Minimum value after pressing the **MAX/MIN** key

|PEAK|: Maximum value of the absolute value of the waveform during the display update interval

Backlight / Auto Power Save (APS)

Backlight



Backlight OFF

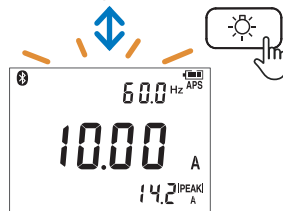

Backlight ON

No operation for approx. 40 sec.: Backlight off
Switching the auto backlight off function: p. 18

Auto power save (APS)

(Ordinarily on)

Switching the function: p. 18

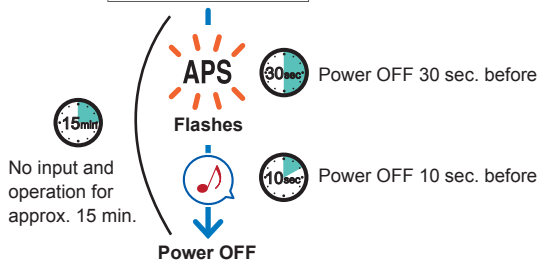

No input and
operation for
approx. 15 min.

APS
Flashes

Power OFF 30 sec. before

Power OFF

Power OFF 10 sec. before

- Set the rotary switch to OFF when restarting the instrument after the APS function.
- The APS function is disabled while displaying the MAX/MIN/AVG value and during energy integration.
- Bluetooth® communications are treated as an operation for the purpose of the APS function.

Measurement Using the Clamp Adapter

A clamp adapter (sold separately) can be used to measure currents that are larger than the rated input current.

1 Select the CT ratio.

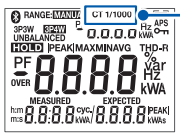

Rotary switch	CT ratio
A	1/1 (not shown)
W	1/10
Wh	1/100
3PW	1/1000

Set the CT ratio as appropriate for the clamp adapter.
(e.g.: For the 9290-10 Clamp on Adapter, **1/10**)

3 Clamp

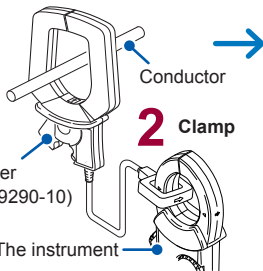

4 Perform measurement.

Bluetooth® Communications (only for CM3286-01)

The CM3286-01 is a clamp-style meter with Bluetooth® low energy support. When the Bluetooth® function is enabled, you can review measurement data and create measurement reports on mobile devices (iPhone, iPad, iPad Mini, iPad Pro, iPod Touch, and Android™ devices). For more information about this functionality, see the [Help](#) function in the application software GENNECT Cross.

- 1** Install the GENNECT Cross on your mobile device. (p.58)
- 2** Enable the Bluetooth® function on the CM3286-01. (p.59)
- 3** Launch the GENNECT Cross and pair it with the CM3286-01. (p.60)
- 4** Select the [General Measurement](#), [Logging \(Recording\)](#), or [Electricity Theft Detection](#) function. (p.61)

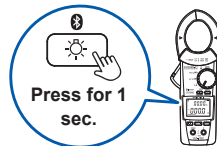

Installing the application software GENNECT Cross

Search for “GENNECT Cross” on the App Store from your iPhone, iPad or other Apple device, or on Google Play from your Android device. Then download and install the GENNECT Cross. You will need an Apple ID to download the app from the App Store, or a Google account to download the app from Google Play. For more information about how to register an account, contact the store at which you purchased your device.



- Because the CM3286-01 emit radio waves, use in a country or region where they have not been approved may be subject to fines or other penalties as a violation of applicable laws or regulations. For more information, see the attached “Precautions Concerning Use of Equipment That Emits Radio Waves” or go to our website.
- The CM3286-01 availability is limited to certain countries. For more information, contact your authorized Hioki distributor or reseller.
- Bluetooth® communications range varies greatly with distance from obstructions (walls, metal obstruction, etc.) as well as distance from the floor or ground. To ensure stable measurement, verify adequate signal strength.
- Although this application software is provided free of charge, downloading or use of the application software may incur Internet connection charges. Such charges are the sole responsibility of the user.
- This application software is not guaranteed to operate on all mobile devices.

Turning on the Bluetooth® function

Bluetooth® function OFF



Press for 1 sec.

Bluetooth® function ON



Bluetooth icon will flash when the instrument is connected to a mobile device.



Pairing the app with the CM3286-01

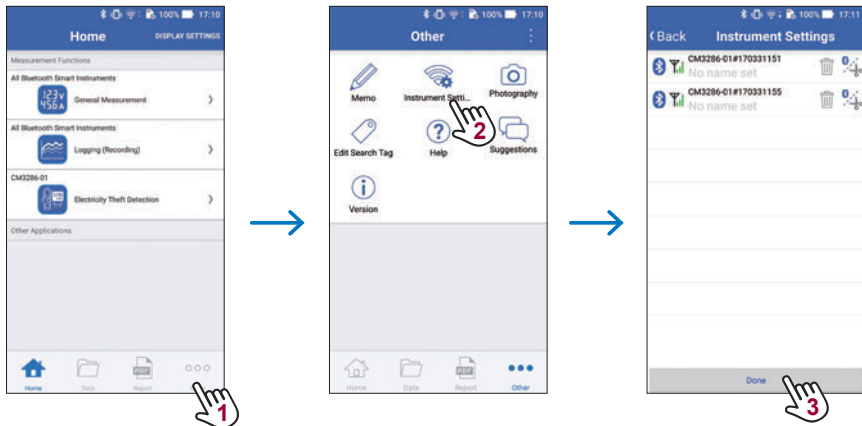

- When the app is launched for the first time (before being paired with any instrument), the **Instrument Settings** screen will be displayed.
- While the mobile device is displaying the **Instrument Settings** screen, simply move it close to a CM3286-01 to automatically pair it with the instrument (the app can be paired with up to 8 instruments).
- Allow about 5 to 30 seconds for the instrument to pair with the app after being turned on. If the instrument fails to pair within 1 minute, relaunch GENNECT Cross and cycle the instrument's power.

Making measurements with the Bluetooth® function

Select the **General Measurement**, **Logging (Recording)**, or **Electricity Theft Detection** function on the **Home** screen. For more information about each function, see the **Help** function in the GENNECT Cross.

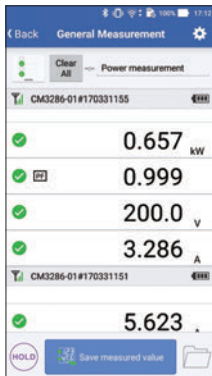

General Measurement

Saves measured values from multiple channels.

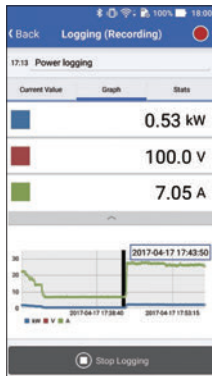

Logging (Recording)

Simple logging (up to 24 hours)

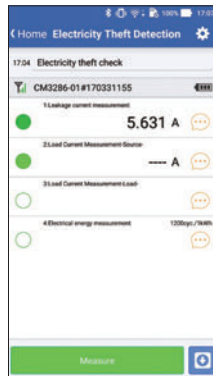

Electricity Theft Detection

Creates a result report by measuring current and energy.

Repairs, Inspections, and Cleaning

WARNING



Customers are not allowed to modify, disassemble, or repair the instrument. Doing so may cause a fire, an electric shock, or an injury..

Cleaning

- To clean the instrument, wipe it gently with a soft cloth moistened with water or mild detergent.
- Measurements are degraded by dirt on the mating surfaces of the jaw, so keep the surfaces clean by gently wiping with a soft, dry cloth.
- Wipe the LCD gently with a soft, dry cloth.

Disposal

Handle and dispose of the instrument and batteries in accordance with local regulations.

Precautions during shipment

Be sure to observe the following precautions:

- To avoid damage to the instrument, remove the batteries, accessories, and options from the instrument. Moreover, be sure to pack in a double carton. Damage that occurs during transportation is not covered by the warranty.
- When sending the instrument for repair, be sure to include details of the problem.

Calibrations

The calibration period varies depending on the status of the instrument or installation environment. We recommend that the calibration period be determined in accordance with the status of the instrument or installation environment. Please contact your Hioki distributor to have your instrument periodically calibrated.

Troubleshooting

If damage is suspected, check the following before contacting your authorized Hioki distributor or reseller.

Symptom	Verification and/or Solution
<ul style="list-style-type: none"> The instrument is indicating an abnormal measured value for current. 	<ul style="list-style-type: none"> Is the measured current value too small for the instrument's measurement range? Wrap the wire around the jaw one or more times. Each additional wrap of the wire will increase the measured value, so that wrapping it once yields a measured value that is twice the actual value and wrapping it twice yields a measured value that is three times the actual value. Are the tips of the jaw open? Is the jaw damaged? If the sensor is damaged or cracked, it will not be able to measure current accurately. Send the instrument for repair.
<ul style="list-style-type: none"> When readings from the instrument are compared with those of another clamp-on current meter, the measured values differ. 	<ul style="list-style-type: none"> The instrument cannot accurately measure waveforms that contain a component that falls outside the frequency characteristics range. Since the instrument performs true RMS measurement, it can accurately measure distorted waveforms. When measuring a distorted waveform, the measured value will differ from a clamp-on current meter that uses the averaging method.



Symptom	Verification and/or Solution
<ul style="list-style-type: none">• The current value is larger than expected.• A current value is displayed even though there is no input.	<ul style="list-style-type: none">• The instrument cannot perform measurement accurately in the presence of a strong magnetic field from a source such as a nearby transformer or high-current circuit or in the presence of a strong electric field from a source such as a wireless device.
<ul style="list-style-type: none">• A sound is being emitted by the instrument's jaw.	<ul style="list-style-type: none">• The jaw may emit sound when measuring AC currents in excess of approx. 500 A, however, there is no effect on the measurement.
<ul style="list-style-type: none">• The measured value does not appear.• No measured value is displayed, even when the connection cords are shorted.	<ul style="list-style-type: none">• Insert the connection cords all the way.• Use the proper measurement method. <p>If no measured value is displayed after attempting the above two solutions, the instrument may be broken. Have the instrument repaired.</p>

Error display

Error display	Description		Solution
Err 001	ROM error	Program	Repair is necessary. Please contact your authorized Hioki distributor or reseller.
Err 002	ROM error	Adjustment data	
Err 005	ADC error	Hardware malfunction	
Err 008	Bluetooth® error	Hardware malfunction (only for CM3286-01)	

Warning display

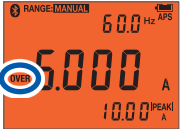
Display	Buzzer	Cause	Solution
	Flashes red	–	Measurement resulted in a negative active power value. The instrument may not be connected properly. Reconnect the instrument to the circuit being measured.

Display	Buzzer	Cause	Solution
 <p>e.g.: for current measurement</p>	Flashes red	Intermittent sound	<p>A current or voltage exceeding the maximum input was input to the instrument.</p> <p>Stop measurement immediately as the current or voltage cannot be measured by the instrument. For current measurement, the optional 9290-10 can be used to measure currents of up to 1000 AAC.</p> <p>When manual range is 6 A and 60 A range, this warning display will not appear.</p>
 <p>e.g.: for current measurement</p>	Lights red	—	<p>A current or voltage exceeding the range was input while using a manual range.</p> <p>Change the measurement range or select the AUTO range.</p>
	Lights red	Intermittent sound	Phase detection indicated reverse phase.

Specifications

General Specifications

Operating environment	Indoors, pollution degree 2, altitude up to 2000 m (6562 ft.)
Operating temperature and humidity	Temperature -25°C (-13°F) to 65°C (149°F)
	Humidity -25°C (-13°F) or higher but less than 40°C (104°F): 80% RH or less 40°C (104°F) or higher but less than 45°C (113°F): 60% RH or less 45°C (113°F) to 65°C (149°F): 50% RH or less (no condensation)
Storage temperature and humidity	Temperature -25°C (-13°F) to 65°C (149°F)
	Humidity -25°C (-13°F) or higher but less than 40°C (104°F): 80% RH or less 40°C (104°F) or higher but less than 45°C (113°F): 60% RH or less 45°C (113°F) to 65°C (149°F): 50% RH or less (no condensation) Remove batteries before storing the instrument.
Dustproof and waterproof	Grip except lever: IP54 (EN 60529) Jaw, barrier, lever: IP50 (EN 60529)

Specifications

Standards (other than wireless communications functionality)	Safety: EN 61010 EMC: EN 61326
Power supply	LR03 alkaline battery ×2 Rated supply voltage: 1.5 V DC ×2 Maximum rated power: 550 mVA
Continuous operating time	Approx. 25 hours (Backlight display off, Bluetooth® communication off, at 23°C, as a referential) Approx. 18 hours (Backlight display off, Bluetooth® communication on, at 23°C, as a referential)
Interface (only for CM3286-01)	Bluetooth® 4.0LE  Bluetooth®
Dimensions	Approx. 82W × 241H × 37D mm (3.23"W × 9.49"H × 1.46"D)
Jaw dimensions	Approx. 79W × 20D mm (3.11"W × 0.79"D)
Maximum measurable conductor diameter	46 mm (1.81")
Mass	Approx. 450 g (15.9 oz.) (including batteries)
Product warranty period	1 year
Accessories	See p.2
Options	See p.4

Input/Output/Measurement Specifications

Basic Specifications

Measurement items	AC current RMS value/AC current peak value (no polarity)/AC current frequency AC voltage RMS value/AC voltage peak value (no polarity)/AC voltage frequency Single-phase active power/Single-phase apparent power/Single-phase reactive power/Single-phase power factor/Single-phase zero-cross phase angle Balanced 3-phase active power/Balanced 3-phase reactive power/Balanced 3-phase apparent power/Balanced 3-phase power factor/Balanced 3-phase zero-cross phase angle Single-phase active energy (only positive values added)/Phase detection
Maximum input current	See the frequency derating characteristics (p.72). (up to 200 Hz, 600 A or less; above 200 Hz, 120000 A·Hz or less)
Maximum measuring voltage	600 V AC
Maximum rated voltage to earth	600 V AC (Measurement category IV) 1000 V AC (Measurement category III)
Maximum rated voltage to terminal	Anticipated transient overvoltage 8000 V
Measurement method	True RMS measurement with digital sampling
Measurement terminal	COM terminal and V terminal
Input impedance	1 M Ω or greater

Specifications

Display update interval 2 times/sec.

Response time 1 sec.

Crest factor 3 or less for current 6 A and 60 A range
1.6 or less for current 600 A range and voltage 600 V range

Zero-display range

- Voltage and current RMS values: 29 counts or less
- If they fall within the zero-display range, current (voltage) peak values and active/apparent/reactive power values are shown as zero, while current (voltage) frequency, power factor, and zero-cross phase values are shown as "----."
- A value of 0 is used in single-phase active energy calculations.

Frequency derating characteristics

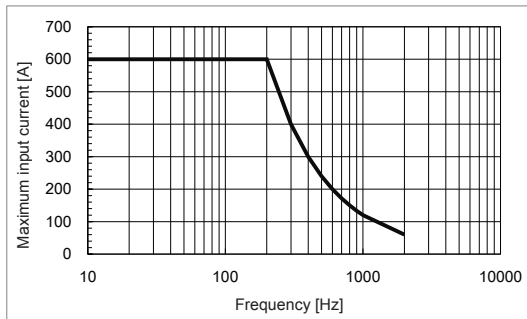

Accuracy Specifications

Conditions of guaranteed accuracy	<p>Guaranteed accuracy period: 1 year</p> <p>Guaranteed accuracy period after adjustment made by Hioki: 1 year</p> <p>Guaranteed accuracy for temperature and humidity: $23^{\circ}\text{C}\pm 5^{\circ}\text{C}$ ($73^{\circ}\text{F}\pm 9^{\circ}\text{F}$), 80% RH or less (no condensation)</p> <p>Number of jaw open/close cycles: 10000 times or less</p>
Input conditions for guaranteed accuracy	Sine wave input
Effects of external magnetic fields	<p>DC/AC 60 Hz, with a 400 A/m external magnetic field: 0.10 A or less</p>
Effects of conductor position	At all positions around the jaw's center-point reference: within $\pm 0.5\%$ (100 A input, $f \leq 100$ Hz)
Temperature coefficient	Add "measurement accuracy $\times 0.1/^{\circ}\text{C}$ " (excluding $23^{\circ}\text{C}\pm 5^{\circ}\text{C}$ ($73^{\circ}\text{F}\pm 9^{\circ}\text{F}$)).
Effects of sensor phase	$\pm 1^{\circ}$ (50 Hz to 60 Hz)

See "Accuracy Table" (p. 75)

External Interface (Bluetooth®) Specifications

Display function	Display of measured values on a iOS device or a Android device, using Bluetooth® communications.
Interface	Bluetooth® 4.0 LE
Antenna power	Maximum +0 dBm (1 mW)
Communications range	10 m (line of sight)
Communications profile	GATT (Generic Attribute Profile)
Supported devices	iOS (iPhone5, 3 rd iPad, iPad mini, iPad Pro, 5 th iPod Touch or later) Android (Only for Bluetooth® low energy models)
Supported OS	iOS 8 or later, Android 4.3 or later

Application Software Specifications

Electricity theft detection function	Creates an result report by measuring current and energy in conjunction with the instrument.
Others	See the GENNECT Cross specifications (data saving, logging (recording) function)

Accuracy Table

(1) AC Current Measurement

The current RMS (I_{RMS}) and current peak value ($I_{|PEAK|}$) ranges will change at the same time.

Auto range threshold:

Range up: Current RMS value greater than 6000 count

Range down: Current RMS value less than 540 count

AC current RMS (I_{RMS})	Range (Accuracy guarantee range)	Resolution	Accuracy		
		Display range	45 Hz ≤ f ≤ 66 Hz	66 Hz < f ≤ 500 Hz	500 Hz < f ≤ 1 kHz
	6.000 A (0.060 A to 6.000 A)	0.001 A	±1.3% rdg. ±3 dgt.	±2.0% rdg. ±5 dgt.	±5.0% rdg. ±5 dgt.
		0.000 A to 6.000 A			
	60.00 A (0.60 A to 60.00 A)	0.01 A	±1.0% rdg. ±3 dgt.	±1.5% rdg. ±5 dgt.	±3.0% rdg. ±5 dgt.
		0.00 A to 60.00 A			
	600.0 A (6.0 A to 600.0 A)	0.1 A			-
		0.0 A to 600.0 A			

Accuracy Table

AC current peak value (I_{PEAK}) Zero to Peak No polarity (absolute value of the maximum wave height during the display update interval)	Range (Accuracy guarantee range is specified in terms of current RMS values.)	Resolution	Accuracy		
		Display range	45 Hz \leq f \leq 66 Hz	66 Hz < f \leq 500 Hz	500 Hz < f \leq 1 kHz
	6.000 A (0.060 A to 6.000 A)	0.01 A	$\pm 3.0\%$ rdg. ± 5 dgt.		$\pm 5.0\%$ rdg. ± 5 dgt.
		0.00 A to 18.00 A			
	60.00 A (0.60 A to 60.00 A)	0.1 A	$\pm 2.5\%$ rdg. ± 5 dgt.		$\pm 4.0\%$ rdg. ± 5 dgt.
		0.0 A to 180.0 A			
	600.0 A (6.0 A to 600.0 A)	1 A			—
		0 A to 1000 A			
AC current frequency ($FREQ_i$)	Range (Accuracy guarantee range)	Resolution	Accuracy		
		Display range	Current frequency values are shown as "----" when the current RMS value is less than 150 count. Current frequency values of less than 45.0 Hz are shown as "----."		
999.9 Hz (45.0 Hz to 999.9 Hz)		0.1 Hz	$\pm 0.3\%$ rdg. ± 3 dgt.		
		45.0 Hz to 999.9 Hz			

(2) AC Voltage Measurement

AC voltage RMS value (U_{RMS})	Range (Accuracy guarantee range)	Resolution	Accuracy		
		Display range	45 Hz \leq f \leq 66 Hz	66 Hz < f \leq 500 Hz	500 Hz < f \leq 1 kHz
600 V (80.0 V to 600.0 V)		0.1 V	$\pm 0.7\%$ rdg.	$\pm 1.0\%$ rdg.	$\pm 3.0\%$ rdg.
		0.0 V to 600.0 V	± 3 dgt.	± 5 dgt.	± 5 dgt.
AC voltage peak value (U_{PEAK}) Zero to Peak No polarity (absolute value of the maximum wave height during the display update interval)	Range (Accuracy guarantee range is specified in terms of current RMS values.)	Resolution	Accuracy		
		Display range	45 Hz \leq f \leq 66 Hz	66 Hz < f \leq 500 Hz	500 Hz < f \leq 1 kHz
600 V (80.0 V to 600.0 V)		1 V	$\pm 2.5\%$ rdg. ± 5 dgt.		$\pm 4.0\%$ rdg. ± 5 dgt.
		0 V to 1000 V			

Accuracy Table

AC voltage frequency ($FREQ_V$)	Range (Accuracy guarantee range)	Resolution	Accuracy Voltage frequency values are shown as "----" when the voltage RMS value is less than 150 count. Voltage frequency values of less than 45.0 Hz are shown as "----."
		Maximum display	
	999.9 Hz (45.0 Hz to 999.9 Hz)	0.1 Hz	±0.3% rdg. ± 3 dgt.
		999.9 Hz	

(3) Single-phase power measurement, balanced 3-phase/4-wire power measurement

Auto range threshold:

Range up: Current RMS value greater than 6000 count

Range down: Current RMS value less than 540 count

Effective measuring range	Current RMS value (I_{RMS})	0.060 A to 600.0 A Value must fall within the current measurement range's guaranteed accuracy range.
	Voltage RMS value (U_{RMS})	80.0 V to 600.0 V
	Frequency	50 Hz/60 Hz

Single-phase active power/ Balanced 3-phase/4-wire active power ($PIP_{(3P4W)}$)	Range configuration (minimum resolution)			Current range		
				6.000 A	60.00 A	600.0 A
	Voltage range	600.0 V	Single-phase	3.600 kW (0.001 kW)	36.00 kW (0.01 kW)	360.0 kW (0.1 kW)
			3-Phase 4-Wire	10.80 kW (0.01 kW)	108.0 kW (0.1 kW)	1080 kW (1 kW)
	Accuracy (Power factor =1)		Single-phase	±2.0% rdg. ±7 dgt.		
			3-Phase 4-Wire	±2.0% rdg. ±1.7% rdg. ±2 dgt. ±3 dgt.		
Single-phase apparent power/ Balanced 3-phase/4-wire apparent power ($SIS_{(3P4W)}$) Single-phase reactive power/ Balanced 3-phase/4-wire reactive power ($QIQ_{(3P4W)}$)	Accuracy	±1 dgt. relative to calculation from measured values				
	Range configuration	For the above active power range configuration, the unit [W] is replaced by [VA] for apparent power values. For reactive power values, the unit [W] is replaced by [var].				

Accuracy Table

Single-phase power factor/ Balanced 3-phase/4-wire power factor ($PF_{1PF_{(3P4W)}}$)	Accuracy	± 1 dgt. relative to calculation from measured values	
	Range configuration	Regeneration	-1.000 to -0.001
		Consumption	0.000 to 1.000
Zero-cross phase angle (ϕ)*	Accuracy	$\pm 3^\circ$	
	Range configuration	Lead	-180.0° to -0.1°
		Lag	0.0° to 179.9°

* Value is calculated based on the measurement of the zero-cross phase difference for the voltage and current waveforms (positive [no sign] when the current lags the voltage and negative when the current leads the voltage).

(4) Balanced 3-phase/3-wire power measurement

Auto range threshold:

Range up: Current RMS value greater than 6000 count

Range down: Current RMS value less than 540 count

Effective measuring range	Current RMS value (I_{RMS})	0.060 A to 600.0 A Value must fall within the current measurement range's guaranteed accuracy range.
	Voltage RMS value (U_{RMS})	80.0 V to 600.0 V
	Frequency	50 Hz/60 Hz

Balanced 3-phase/3-wire active power ($P_{(3P3W)}$)	Accuracy	$\pm 3.0\%$ rdg. ± 10 dgt. (Power factor =1)				
	Range configuration (minimum resolution)			Current range		
				6.000 A	60.00 A	600.0 A
		Voltage range	600.0 V	7.200 kW (0.001 kW)	72.00 kW (0.01 kW)	720.0 kW (0.1 kW)
Balanced 3-phase/3-wire apparent power ($S_{(3P3W)}$)	The unit [W] is replaced by [VA] for apparent power values.					
Balanced 3-phase/3-wire reactive power ($Q_{(3P3W)}$)	Accuracy	± 1 dgt. relative to calculation from measured values				
	Range configuration	For the above active power range configuration, the unit [W] is replaced by [var].				
Balanced 3-phase/3-wire power factor ($PF_{(3P3W)}$)	Accuracy	$\pm 3^\circ \pm 2$ dgt. (Calculated from the balanced 3-phase/3-wire zero-cross phase angle)				
	Range configuration	Regeneration	-0.001			
		Consumption	0.000 to 1.000			
Balanced 3-phase/3-wire zero-cross phase angle ($\phi_{(3P3W)}$)*	Accuracy	$\pm 3^\circ$				
	Range configuration	Lead	-90.0° to -0.1°			
		Lag	0.0° to 90.0°			

Accuracy Table

* Value is calculated based on the measurement of the zero-cross phase difference for the voltage and current waveforms (positive [no sign] when the current lags the voltage and negative when the current leads the voltage).

(5) Single-phase active energy measurement (AC)

Effective measuring range	Current RMS value (I_{RMS})	0.060 A to 600.0 A Value must fall within the current measurement range's guaranteed accuracy range.
	Voltage RMS value (U_{RMS})	80.0 V to 600.0 V
	Frequency	50 Hz/60 Hz

Single-phase active energy (Wh)	Measurement method		<p>Positive active power values are added every 0.5 s.* A value of zero is added when the active power is negative.</p> <p>* When stopping integration, the energy measured during the last 0.5 sec. is divided into 5 and added every 0.1 sec.</p>
	Range configuration	Display range	<ul style="list-style-type: none"> • After the single-phase active power range is selected, integration starts with a value of 0.00 Wh. Only auto-range operation is supported for active energy measurement. When values exceed 9999 count, the range is switched to the next higher range. • The range is fixed to the active power range in use when integrated began.
	99.99 Wh	0.00 Wh to 99.99 Wh	
	999.9 Wh	100.0 Wh to 999.9 Wh	
	9.999 kWh	1.000 kWh to 9.999 kWh	
	99.99 kWh	10.00 kWh to 99.99 kWh	
	999.9 kWh	100.0 kWh to 999.9 kWh	
	9999 kWh	1000 kWh to 9999 kWh	

Accuracy Table

Integration time display	59:59 [min:sec]	The time is incremented by 1 s from 00:00 [min:sec]. When 59:59 [min:sec] is exceeded, the range is switched to the 48:00 [hour:min] range. During integration using the 48:00 [hour:min] range, the “:” display flashes every 0.5 s.
	48:00 [hour:min]	

(6) Phase detection

Detected voltage range	80 V AC to 600 V AC
Detection target frequency	50 Hz/60 Hz (sine wave)
Phase order detection*	Normal phase (Display: 123) Reverse phase (Display: 321) Open phase or unable to measure (Display: ---)

* After the second measurement display appears, and the second measurement value does not become stable over 10 seconds, it is unable to make a measurement.

Range configuration when setting a CT ratio

CT ratio	1/1 (default value)	1/10	1/100	1/1000	Remarks
Current RMS value	600.0 A	6000 A	–	–	CT ratio 1/1 Same accuracy specifications as 600.0 A.
	60.00 A	600.0 A	6000 A	–	CT ratio 1/1 Same accuracy specifications as 60.00 A.
	6.000 A	60.00 A	600.0 A	6000 A	CT ratio 1/1 Same accuracy specifications as 6.000 A.
Current peak value	1000 A	10.00 kA	–	–	CT ratio 1/1 Same accuracy specifications as 600.0 A.
	180.0 A	1800 A	18.00 kA	–	CT ratio 1/1 Same accuracy specifications as 60.00 A.
	18.00 A	180.0 A	1800 A	18.00 kA	CT ratio 1/1 Same accuracy specifications as 6.000 A.
Single-phase active power	360.0 kW	3600 kW	–	–	CT ratio 1/1 Same accuracy specifications as 360.0 kW.
	36.00 kW	360.0 kW	3600 kW	–	CT ratio 1/1 Same accuracy specifications as 36.00 kW.
	3.600 kW	36.00 kW	360.0 kW	3600 kW	CT ratio 1/1 Same accuracy specifications as 3.600 kW.

Accuracy Table

CT ratio	1/1 (default value)	1/10	1/100	1/1000	Remarks
Balanced 3-phase/3-wire active power	720.0 kW	7200 kW	–	–	CT ratio 1/1 Same accuracy specifications as 720.0 kW.
	72.00 kW	720.0 kW	7200 kW	–	CT ratio 1/1 Same accuracy specifications as 72.00 kW.
	7.200 kW	72.00 kW	720.0 kW	7200 kW	CT ratio 1/1 Same accuracy specifications as 7.200 kW.
Balanced 3-phase/4-wire active power	1080 kW	9999 kW* ¹	–	–	CT ratio 1/1 Same accuracy specifications as 1080 kW.
	108.0 kW	1080 kW	9999 kW* ¹	–	CT ratio 1/1 Same accuracy specifications as 108.0 kW.
	10.80 kW	108.0 kW	1080 kW	9999 kW* ¹	CT ratio 1/1 Same accuracy specifications as 10.80 kW.

- Add the accuracy of the appropriate CT.
- The unit is replaced as below for apparent power and reactive power, relative to the active power range.
Apparent power: kVA
Reactive power: kVAR

*1 Multiply the dgt. error indicated in the accuracy specifications noted in the “Remarks” column by 10.

Equations

(1) Single-phase power measurement

Apparent power	S	$U_{\text{RMS}} \cdot I_{\text{RMS}}$	<ul style="list-style-type: none"> The active power P has no sign during consumption and a negative sign during generation. Due to the effects of measurement error, $S= P$ and $Q=0$ are used when $S< P$.
Reactive power	Q	$\sqrt{S^2 - P^2}$	
Power factor	PF	$\frac{P}{S}$	

(2) Balanced 3-phase/3-wire power measurement

Balanced 3-phase/3-wire zero-cross phase angle	$\phi_{(3P3W)}$	$\phi - 30^\circ$	<ul style="list-style-type: none"> The symbol ϕ represents the zero-cross phase angle of the voltage U_{12} and the current I_1. The symbol S represents the apparent power of the line voltage U_{12} and the wire current I_1.
Balanced 3-phase/3-wire power factor	$PF_{(3P3W)}$	$\cos \{ \phi_{(3P3W)} \}$	
Balanced 3-phase/3-wire active power	$P_{(3P3W)}$ [W]	$\sqrt{3} \cdot PF_{(3P3W)} \cdot S$	
Balanced 3-phase/3-wire apparent power	$S_{(3P3W)}$ [VA]	$\sqrt{3} \cdot S$	
Balanced 3-phase/3-wire reactive power	$Q_{(3P3W)}$ [var]	$\sqrt{S_{(3P3W)}^2 - P_{(3P3W)}^2}$	

(3) Balanced 3-phase/4-wire power measurement

Balanced 3-phase/4-wire active power	$P_{(3P4W)}$ [W]	$3 \cdot P$	<ul style="list-style-type: none"> The symbol P represents the active power of the phase voltage U_1 and the wire current I_1. The symbol S represents the apparent power of the phase voltage U_1 and the wire current I_1. The symbol Q represents the reactive power of the phase voltage U_1 and the wire current I_1. The active power P has no sign during consumption and a negative sign during generation. Due to the effects of measurement error, $S= P$ and $Q=0$ are used when $S < P$.
Balanced 3-phase/4-wire apparent power	$S_{(3P4W)}$ [VA]	$3 \cdot S$	
Balanced 3-phase/4-wire reactive power	$Q_{(3P4W)}$ [var]	$3 \cdot Q$	
Balanced 3-phase/4-wire power factor	$PF_{(3P4W)}$	$\frac{P_{(3P4W)}}{S_{(3P4W)}}$	

(4) Unbalanced 3-phase/3-wire power measurement

Unbalanced 3-phase/3-wire active power	$P_{(UB3P3W)}$ [W]	$P_1 + P_2$	<ul style="list-style-type: none"> The symbol P_1 represents the active power of the line voltage U_{21} and the wire current I_1. The symbol P_2 represents the active power of the line voltage U_{23} and the wire current I_3. The active power P has no sign during consumption and a negative sign during generation.
--	-----------------------	-------------	---

(5) Unbalanced 3-phase/4-wire power measurement

Unbalanced 3-phase/4-wire active power	$P_{(UB3P4W)}$ [W]	$P_1+P_2+P_3$	<ul style="list-style-type: none"> • The symbol P_1 represents the active power of the phase voltage U_1 and the wire current I_1. • The symbol P_2 represents the active power of the phase voltage U_2 and the wire current I_2. • The symbol P_3 represents the active power of the phase voltage U_3 and the wire current I_3. • The active power P has no sign during consumption and a negative sign during generation.
Unbalanced 3-phase/4-wire apparent power	$S_{(UB3P4W)}$ [VA]	$S_1+S_2+S_3$	<ul style="list-style-type: none"> • The symbol S_1 represents the apparent power of the phase voltage U_1 and the wire current I_1. • The symbol S_2 represents the apparent power of the phase voltage U_2 and the wire current I_2. • The symbol S_3 represents the apparent power of the phase voltage U_3 and the wire current I_3. • Due to the effects of measurement error, $S= P$ is used when $S< P$.
Unbalanced 3-phase/4-wire reactive power	$Q_{(UB3P4W)}$ [var]	$Q_1+Q_2+Q_3$	<ul style="list-style-type: none"> • The symbol Q_1 represents the reactive power of the phase voltage U_1 and the wire current I_1. • The symbol Q_2 represents the reactive power of the phase voltage U_2 and the wire current I_2. • The symbol Q_3 represents the reactive power of the phase voltage U_3 and the wire current I_3. • Due to the effects of measurement error, $Q=0$ is used when $S< P$.

Equations

Unbalanced 3-phase/4-wire power factor	$PF_{(UB3P4W)}$	$\frac{P_{(UB3P4W)}}{S_{(UB3P4W)}}$	-
---	-----------------	-------------------------------------	---

Warranty Certificate **HIOKI**

Model	Serial No.	Warranty period
		One (1) year from date of purchase (___ / ___ / ___)

This product passed a rigorous inspection process at Hioki before being shipped.

In the unlikely event that you experience an issue during use, please contact the distributor from which you purchased the product, which will be repaired free of charge subject to the provisions of this Warranty Certificate. This warranty is valid for a period of one (1) year from the date of purchase. If the date of purchase is unknown, the warranty is considered valid for a period of one (1) year from the product's date of manufacture. Please present this Warranty Certificate when contacting the distributor. Accuracy is guaranteed for the duration of the separately indicated guaranteed accuracy period.

1. Malfunctions occurring during the warranty period under conditions of normal use in conformity with the Instruction Manual, product labeling (including stamped markings), and other precautionary information will be repaired free of charge, up to the original purchase price. Hioki reserves the right to decline to offer repair, calibration, and other services for reasons that include, but are not limited to, passage of time since the product's manufacture, discontinuation of production of parts, or unforeseen circumstances.
2. Malfunctions that are determined by Hioki to have occurred under one or more of the following conditions are considered to be outside the scope of warranty coverage, even if the event in question occurs during the warranty period:
 - a. Damage to objects under measurement or other secondary or tertiary damage caused by use of the product or its measurement results
 - b. Malfunctions caused by improper handling or use of the product in a manner that does not conform with the provisions of the Instruction Manual
 - c. Malfunctions or damage caused by repair, adjustment, or modification of the product by a company, organization, or individual not approved by Hioki
 - d. Consumption of product parts, including as described in the Instruction Manual
 - e. Malfunctions or damage caused by transport, dropping, or other handling of the product after purchase
 - f. Changes in the product's appearance (scratches on its enclosure, etc.)
 - g. Malfunctions or damage caused by fire, wind or flood damage, earthquakes, lightning, power supply anomalies (including voltage, frequency, etc.), war or civil disturbances, radioactive contamination, or other acts of God
 - h. Damage caused by connecting the product to a network
 - i. Failure to present this Warranty Certificate
 - j. Failure to notify Hioki in advance if used in special embedded applications (space equipment, aviation equipment, nuclear power equipment, life-critical medical equipment or vehicle control equipment, etc.)
 - k. Other malfunctions for which Hioki is not deemed to be responsible

***Requests**

- Hioki is not able to reissue this Warranty Certificate, so please store it carefully.
- Please fill in the model, serial number, and date of purchase on this form.

16-01 EN

HIOKI E.E. CORPORATION

81 Koizumi, Ueda, Nagano 386-1192, Japan
TEL: +81-2668-28-0555
FAX: +81-2668-28-0559

- Please visit our website at www.hioki.com for the following:
 - Regional contact information
 - The latest revisions of instruction manuals and manuals in other languages.
 - Declarations of Conformity for instruments that comply with CE mark requirements.
- All reasonable care has been taken in the production of this manual, but if you find any points which are unclear or in error, please contact your supplier or the International Sales and Marketing Department at Hioki headquarters.
- In the interests of product development, the contents of this manual are subject to revision without prior notice.
- The content of this manual is protected by copyright.
No reproduction, duplication or modification of the content is permitted without the authorization of HIOKI E.E.CORPORATION.

HIOKI

HEADQUARTERS

81 Koizumi, Ueda, Nagano 386-1192, Japan
TEL +81-268-28-0562 FAX +81-268-28-0568
os-com@hioki.co.jp
(International Sales Division)

www.hioki.com

HIOKI USA CORPORATION

www.hiokiusa.com hioki@hiokiusa.com

HIOKI (Shanghai) SALES & TRADING CO., LTD.

www.hioki.cn info@hioki.com.cn

HIOKI SINGAPORE PTE.LTD.

www.hioki.com info-sg@hioki.com.sg

HIOKI KOREA CO., LTD.

www.hiokikorea.com info-kr@hioki.co.jp

HIOKI INDIA ENGINEERING PRIVATE LIMITED

www.hioki.com hioki@hioki.in

1704EN