

HIOKI

Instruction Manual

FT6031

EARTH TESTER

HIOKI E. E. CORPORATION

July 2014 Edition 1 FT6031A981-00 14-07H



600429480

Contents

Introduction.....	1
Verifying Package Contents	1
Options (sold separately)	2
Safety Notes.....	3
Usage Notes.....	8

1 Overview 13

1.1 Overview and Features	13
Overview.....	13
Features.....	13
1.2 Parts Names and Functions.....	15
1.3 How to Use Carrying Case	20

2 How to Measure 21

2.1 Measurement Workflow	21
2.2 Attaching/Removing Protector	24
2.3 Inserting/Replacing Batteries	25
2.4 Inspection before Use.....	29
2.5 Setting Up Comparator (PASS/FAIL Test) ...	31
How to set up comparator.....	32
How to disable comparator	32
2.6 Precise Measurement for Earth Resistance (Precise Measurement Method, Three-pole Method).....	33
Performing zero adjustment.....	35
Connecting measurement cables	36
Measuring earth resistance	39
Stowing	42

2.7	Simplified Measurement for Earth Resistance (Simplified Measurement Method, Two-pole Method).....	44
	Performing zero adjustment.....	46
	Connecting test leads	48
	Measuring earth resistance	51
	Stowing	51
2.8	Cautions and Tips for Measurement	52
	Distance between earthing electrodes.....	52
	Location to install auxiliary earthing rod.....	53
	How to insert / pull out auxiliary earthing rod.....	54
2.9	Auto Power Save (Power-saving Function)	56
2.10	Activating the LCD All-on Display	57
2.11	Displaying the Serial number.....	58

3 Specification 59

3.1	General Specification	59
3.2	Measurement Function/Performance.....	61

4 Maintenance and Service 67

4.1	Repair, Inspection, and Cleaning.....	67
4.2	Troubleshooting	69
4.3	Error Display.....	72

Appendix Appx. 1

Appendix 1	Earth Resistance	Appx. 1
Appendix 2	Measurement Principle	Appx. 3

Introduction

Thank you for purchasing the HIOKI FT6031 Earth Tester. To obtain maximum performance from the product, please read this manual first, and keep it handy for future reference.

Verifying Package Contents

When you receive the instrument, inspect it carefully to ensure that no damage occurred during shipping. In particular, check the accessories, panel switches, and connectors. If damage is evident, or if it fails to operate according to the specifications, contact your authorized Hioki distributor or reseller.

Check the package contents as follows.

FT6031

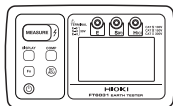











Accessory

- L9840** Auxiliary Earthing Rod (2 piece set) ×1
- L9841** Measurement Cable (alligator clip, black 4 m) ×1
- L9842-11** Measurement Cable (yellow 10 m, equipped with winder) ×1
- L9842-22** Measurement Cable (red 20 m, equipped with winder) ×1
- C0106** Carrying Case ×1
- Protector**
- LR6 Alkaline battery × 4**
- Instruction manual**

Options (sold separately)

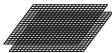
The following options are available for the instrument. Contact your authorized Hioki distributor or reseller when ordering.

L9787	Test Lead (for simplified measurement method, indoor use only, red and black 1.2 m each)	
L9840	Auxiliary Earthing Rod (for precision measurement method, 2 pcs in 1 set) (φ 6 mm, entire length of 270 mm, straight section 235 mm, material: stainless SUS304)	
L9841	Measurement Cable (for precision measurement method, alligator clip, black 4 m)	
L9842-11	Measurement Cable (for precision measurement method, yellow 10 m, equipped with winder)	
L9842-22	Measurement Cable (for precision measurement method, red 20 m, equipped with winder)	
L9843-51	Measurement Cable (for precision measurement method, yellow 50 m, equipped with flat cable winder)	
L9843-52	Measurement Cable (for precision measurement method, red 50 m, equipped with flat cable winder)	
L9844	Measurement Cable (for earthing terminal board, alligator clip, 3 cables in 1 set, red/yellow/black 1.2 m each)	
9050	Earth Nets (2 sheets in 1 set, 300 mm × 300 mm)	
C0106	Carrying Case	

Safety Notes

This instrument is designed to conform to IEC 61010 Safety Standards, and has been thoroughly tested for safety prior to shipment. However, using the instrument in a way not described in this manual may negate the provided safety features.

Before using the instrument, be certain to carefully read the following safety notes.

DANGER



Mishandling during use could result in injury or death, as well as damage to the instrument. Be certain that you understand the instructions and precautions in the manual before use.







WARNING







With regard to the electricity supply, there are risks of electric shock, heat generation, fire, and arc discharge due to short circuits. If persons unfamiliar with electricity measuring instruments are to use the instrument, another person familiar with such instruments must supervise operations.

Notation



In this manual, the risk seriousness and the hazard levels are classified as follows.

 DANGER	<p>Indicates an imminently hazardous situation that will result in death or serious injury to the operator.</p>
 WARNING	<p>Indicates a potentially hazardous situation that may result in death or serious injury to the operator.</p>
 CAUTION	<p>Indicates a potentially hazardous situation that may result in minor or moderate injury to the operator or damage to the instrument or malfunction.</p>
<p>IMPORTANT</p>	<p>Indicates information related to the operation of the instrument or maintenance tasks with which the operators must be fully familiar.</p>
	<p>Indicates a high voltage hazard. If a particular safety check is not performed or the instrument is mishandled, this may give rise to a hazardous situation; the operator may receive an electric shock, may get burnt or may even be fatally injured.</p>
	<p>Indicates prohibited actions.</p>
	<p>Indicates the action which must be performed.</p>
<p>*</p>	<p>Additional information is presented below.</p>

Symbols affixed to the instrument

	Indicates cautions and hazards. When the symbol is printed on the instrument, refer to a corresponding topic in the Instruction Manual.
	Indicates a double-insulated device.
	Indicates DC (Direct Current).
	Indicates AC (Alternating Current).
	Indicates the power switch mark.

Symbols for various standards

	Indicates the Waste Electrical and Electronic Equipment Directive (WEEE Directive) in EU member states.
	Indicates that the instrument conforms to safety regulations set out by the EC Directive.

Screen display

This instrument uses the following screen displays.

A	B	C	D	E	F	G	H	I	J	K	L	M	N	O	P	Q	R	S	T	U	V	W	X	Y	Z
A	b	C	d	E	F	G	H	.	U	L	ñ	o	P	q	r	S	t	U	u	y	Y	z	≡		

1	2	3	4	5	6	7	8	9	0
1	2	3	4	5	6	7	8	9	0

Accuracy

We define measurement tolerances in terms of f.s. (full scale), rdg. (reading) and dgt. (digit) values, with the following meanings:

f.s.	(Maximum display value) The maximum displayable value.
rdg.	(Reading or displayed value) The value currently being measured and indicated on the measuring instrument.
dgt.	(Resolution) The smallest displayable unit on a digital measuring instrument, i.e., the input value that causes the digital display to show a “1” as the least-significant digit.

Measurement categories

To ensure safe operation of measuring instruments, IEC 61010 establishes safety standards for various electrical environments, categorized as CAT II to CAT IV, and called measurement categories.

DANGER



- **Using a measuring instrument in an environment designated with a higher-numbered category than that for which the instrument is rated could result in a severe accident, and must be carefully avoided.**
- **Using a measuring instrument without categories in an environment designated with the CAT II to CAT IV category could result in a severe accident, and must be carefully avoided.**

This instrument conforms to the safety requirements for CAT II 300V, CAT III 150 V, CAT IV 100 V measuring instruments.

- CAT II: When directly measuring the electrical outlet receptacles of the primary electrical circuits in equipment connected to an AC electrical outlet by a power cord (portable tools, household appliances, etc.).
- CAT III: When measuring the primary electrical circuits of heavy equipment (fixed installations) connected directly to the distribution panel, and feeders from the distribution panel to outlets.
- CAT IV: When measuring the circuit from the service drop to the service entrance, and to the power meter and primary overcurrent protection device (distribution panel).

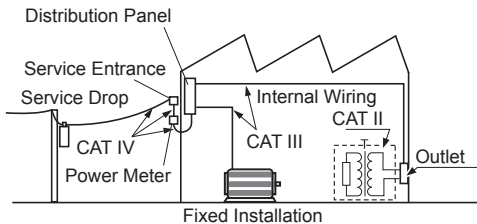

Usage Notes

Follow these precautions to ensure safe operation and to obtain the full benefits of the various functions.

Verifying before usage

Before using the instrument, verify that it operates normally to ensure that no damage occurred during storage or shipping. If you find any damage, contact your authorized Hioki distributor or reseller.

DANGER



Before using the instrument, check that the coating of the test leads and cables are neither ripped nor torn and that no metal parts are exposed. Using the instrument under such conditions could result in electric shock. Replace the test leads and cables with those specified by our company.

IMPORTANT

Use only the specified test leads and cables. Using a non-specified cable may result in incorrect measurements due to poor connection or other reasons.

Use environment of the device

The protection rating for the enclosure of this device (based on EN60529) is *IP65/67.

CAUTION

Although this device has a dust-proof, jet-proof and water-proof structure, it is not for completely shutting out the water intrusion into the inside. Please note that it can be a cause of failure.

***IP65/67:**

This indicates the degree of protection provided by the enclosure of the device against use in hazardous locations, entry of solid foreign objects, and the ingress of water.



- 6: Protected against access to hazardous parts with wire measuring 1.0 mm in diameter. Dust-proof type (Dust shall not penetrate the enclosure.)
- 5: The equipment inside the enclosure is protected against the harmful effects of water projected in jets against the enclosure from any direction.
- 7: Watertight (Quantities of water that may harm the enclosure when it is temporarily immersed in water shall not penetrate the enclosure.)

For details on the operating temperature and humidity, see the specifications. (p. 59)

CAUTION



- Installing the instrument in inappropriate locations may cause a malfunction of instrument or may give rise to an accident. Avoid the following locations.
 - Exposed to corrosive or combustible gases
 - Exposed to water, oil, chemicals, or solvents
 - Exposed to high humidity or condensation
 - Exposed to a strong electromagnetic field or electrostatic charge
 - Near induction heating systems (such as high-frequency induction heating systems and IH cooking equipment)
 - Susceptible to vibration
- Do not store or use the instrument where it could be exposed to direct sunlight or high temperature.
- To avoid damage to the instrument, protect it from physical shock when transporting and handling. Be especially careful to avoid physical shock from dropping.
- Do not place the device on an unstable table or an inclined place. Dropping or knocking down the device can cause injury or damage to the device.

Handling the cables

CAUTION



- To prevent cable damage, do not step on cables or pinch them between other objects. Do not bend or pull on cables at their base.
- The ends of the L9787 Test lead and L9840 Auxiliary earthing rod are sharp. Be careful to avoid injury.
- Use only the specified auxiliary earthing rod, cables, and test leads. Using a non-specified cable may result in incorrect measurements due to poor connection or other reasons.

Precautions during measurement

WARNING



If the instrument is used in locations where the rating indicated on the instrument or cords is exceeded, the instrument may be damaged resulting in personal injury. Do not use the instrument in such locations. See “Measurement categories” (p.7).

Precautions during shipment

CAUTION



- When transporting the instrument, use the original packing materials in which it was shipped, and pack in a double carton. Damage occurring during transportation is not covered by warranty.
- To avoid damage to the instrument, remove the accessories and optional equipment from the instrument before shipment.

1

Overview

1.1 Overview and Features

Overview

The grounding works applied to the distribution lines and electrical facilities are essential for preventing electric shock and fire as well as for safeguarding the equipment.

This instrument is an earth tester that is fully functional for measuring earth resistance for grounding works.

It is capable of providing accurate and highly reliable measurement. The instrument can provide precision measurement (three-pole method) and simplified measurement (two-pole method).

Features

High accuracy

The accuracy of the 200.0 Ω range is $\pm 1.5\%$ rdg. ± 4 dgt.

Auto-range and auto-check for auxiliary earthing electrode

The measurement is performed by simply pressing **MEASURE** button. There is no need for cumbersome range-switching. In addition, the earth potential and auxiliary earthing electrode are automatically checked.

High allowable earth resistance for auxiliary earthing electrode

The resistance that the auxiliary earthing electrode can tolerate is now about 10 times higher than the conventional level. As a result, it can provide measurement under adverse conditions.

**Dust-proof,
jet-proof and water-
proof**

The instrument can withstand water at a depth of 1m for 30 minutes.

**Supplied with a
winder**

The instrument is supplied with a useful winder so that it can be easily prepared and packed up before/after measurement.

**Drop-proof
(when equipped with
a protector)**

Its robust structure can withstand a drop from 1 m onto concrete surface.

1.2 Parts Names and Functions

Front

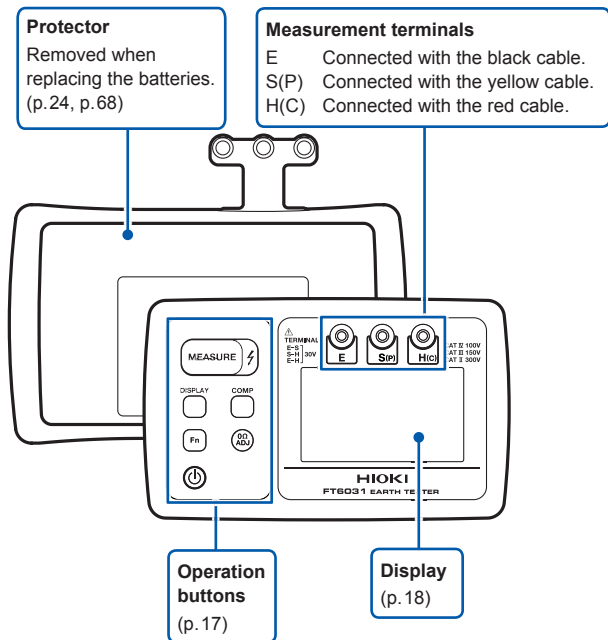

Please do not press the buttons of the device with a sharp object. It may damage the device.

Rear and Sides

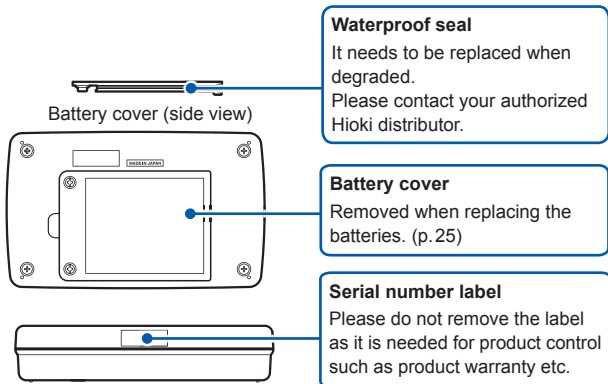



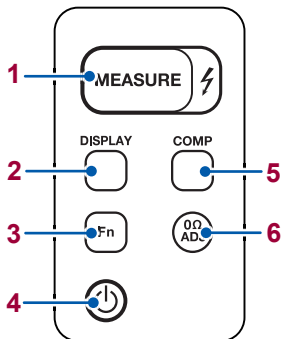





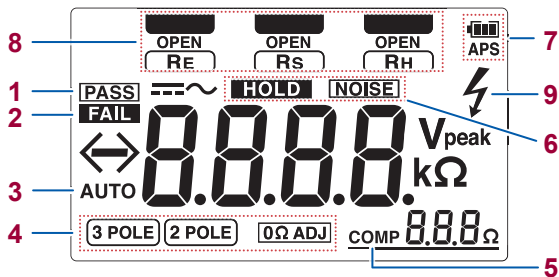



Operation Buttons



1		Start/stop for measuring earth resistance
2		<ul style="list-style-type: none"> • Displays the resistance of each earthing electrode. (p. 39) • Display switching (three-pole method, two-pole method) • DC/AC switching (when measuring earth potential)
3		<ul style="list-style-type: none"> • Function switching (three-pole method, two-pole method) • Unlocks the retained value and displays the current earth potential value.
4		Power ON/OFF
5		Sets/cancels comparator setting (COMP lights up/goes off). (p. 31)
6		Sets/cancels zero adjustment setting. (p. 35, p. 46)

Display



1	PASS	Comparator comparison result (PASS)		Indicates the terminal to be connected with measurement cable or test lead.
2	FAIL	Comparator comparison result (FAIL)		
3	AUTO	Lights up when DC/AC auto-detect setting is enabled for measuring earth potential.		
		Three-pole method (p.33)		
4		Two-pole method (p.44)		
		Zero adjustment (p.35, p.46)		
5	COMP	Displays when comparator setting is enabled. (p.31)		
		Retention of the measured value		
6		Displays when earth potential exceeds allowable range.		
		Displays the battery level. (p.27)		
7	APS	Displayed 30 sec. before auto-power-save function is activated. (p.56)		
			8	
				Earth resistance of earthing electrode
				Earth resistance of auxiliary earthing electrode S
				Earth resistance of auxiliary earthing electrode H
			9	 <p>Live wire warning indicator (red LED lights up as follows)</p> <ul style="list-style-type: none"> • For three-pole method, 30 V or higher between S(P)-E terminals or 85 V or higher between H(C)-E terminals and H(C)-S(P) terminals. • For two-pole method, 30 V or higher between H(C)-E terminals. • When measuring earth resistance.

See p.72 for error display.

1.3 How to Use Carrying Case

Please store the device, winder and other accessories/options into the C0106 Carrying Case as shown in the figure below.

- Please do not store commercially available pegs in this carrying case as those have sharp tips. It may damage the case.
- Please do not wash the carrying case.

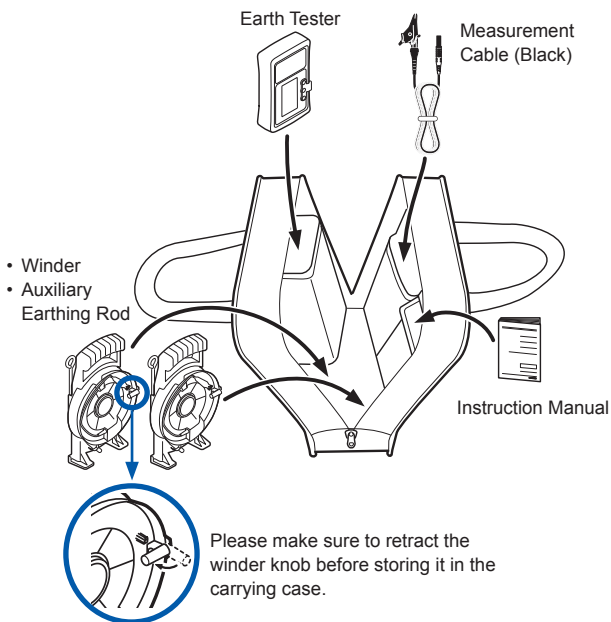

2

How to Measure

2.1 Measurement Workflow

Before using the instrument, be sure to read “Usage Notes” (p.8).

Preparation

Insert the batteries. (p.25)

Perform the startup check. (p.29)

As necessary, have other optional items available and ready.

Measurement

Turn the power on and select the measurement method.

Connect measurement cables or test leads to the measurement terminals.

Perform zero adjustment.
(three-pole method (p.35),
two-pole method (p.46))

Start the measurement.

End of the measurement

Turn the power off and remove measurement cables or test leads from the measuring object.

DANGER



- This product should only be connected to the secondary side of a breaker, so the breaker can prevent an accident if a short circuit occurs. Connections should never be made to the primary side of a breaker, because unrestricted current flow could cause a serious accident if a short circuit occurs.
- Connect the test lead to the instrument first, and then to the active lines to be measured. To avoid electric shock and short circuits, do not short-circuit two wires to be measured by bringing the metal part of the test lead's clip into contact with them. Never touch the metal end of the clip.

WARNING



To avoid electric shock, observe the following precautions.

- Prior to measurement, please make sure that the earthing electrode has been disconnected from the distribution system. The measurement cables L9841, L9842-11, L9842-22, L9843-51 and L9843-52 are measurement cables with the maximum rated voltage of 30 V (between input terminals and the ground) and are designed to measure the earth resistance of an earthing electrode disconnected from the distribution system.
- Turn off all power before connecting cables and test leads.
- Confirm that all connections of cables and test leads are secure to the measurement terminals. The increased resistance of loose connections can lead to overheating and fire.

 **WARNING**

- To prevent electric shock, confirm that the white or red portion (insulation layer) inside the cable of L9787 test lead and L9844 measurement cable are not exposed. If a color inside the cable is exposed, do not use the cable.

 **CAUTION**

- To avoid damaging the cables and test leads, grasp the connector, not the cable, when unplugging the cable.

2.2 Attaching/Removing Protector

Attaching the protector

Tilt the device and slide it into the protector, and then push the entire device into the protector.

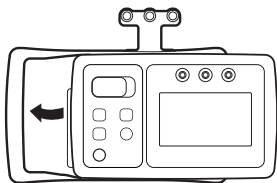

Removing the protector

Hold it with both hands and push the one end of the protector down.

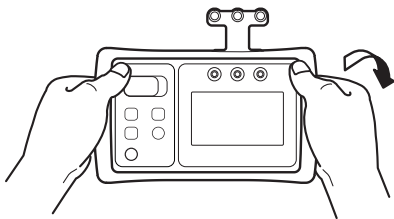

IMPORTANT

If the protector is removed, drop-proof (p.60) will be void.

2.3 Inserting/Replacing Batteries

Before using the instrument first time, insert 4 LR6 alkaline batteries. Before measurements, check that the battery level is sufficient. When the battery charge is low, replace the batteries.

WARNING



- To avoid electric shock, turn off the power and disconnect the cables and test leads before replacing the batteries.
- To prevent instrument damage or electric shock, use only the screws for securing the battery cover in place that shipped with the product. If you have lost any screw or find that any screws are damaged, please contact your Hioki distributor for a replacement.



- Battery may explode if mistreated. Do not short-circuit, disassemble or dispose of in fire. Do not recharge alkaline batteries. Handle and dispose of batteries in accordance with local regulations.



- After replacing the batteries, replace the cover, screws, and put on the protector before using the instrument.

CAUTION

Poor performance or damage from battery leakage could result. Observe the cautions listed below.







- Do not mix new and old batteries, or different types of batteries.
- Be careful to observe the battery polarity during installation.
- Do not use batteries after their recommended expiry date.
- Do not allow used batteries to remain in the instrument.



- To avoid corrosion from battery leakage and/or damage to the instrument, remove the batteries from the instrument if it is to be kept in storage for an extended period.

- If the battery level is low,  mark blinks. To carry out measurement, the batteries need to be replaced with new ones.
- After use, be sure to turn off the instrument.
- Although rechargeable batteries (nickel-hydride) can be used for measurement, the battery level indicator will not be accurately displayed.
- When replacing the batteries after cleaning, the replacement should be carried out after the device has been completely dried.
- The operating temperature of the batteries included in the shipment is -10°C to 45°C (14°F to 113°F). When using this device outside this temperature range, use batteries that can support such a low or high temperature range.

Battery warning indicator

	Fully charged.
	As the battery charge diminishes, black charge bars disappear, one by one, from the left of the battery indicator.
	The battery voltage is low. Replace the batteries as soon as possible.
	(Blinks) The battery is exhausted. Replace the batteries.

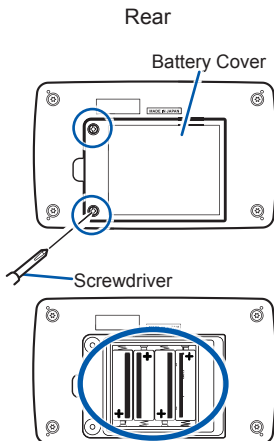

- 1** Have the following items available and ready.
 - Phillips screwdriver
 - LR6 Alkaline battery × 4
- 2** Turn off the device and remove the measurement cables or test leads from the device.
- 3** Remove the protector. (p.24)
- 4** Unscrew the screws of the battery cover with a phillips screwdriver.
- 5** Remove the battery cover. Do not remove the waterproof seal from the battery cover.
- 6** When replacing the batteries, all of the old batteries should be removed.
- 7** Pay attention to the polarities of the batteries when inserting 4 new batteries (LR6).
- 8** Reattach the battery cover onto the device and tighten the screws.
- 9** Attach the protector. (p.24)

2.4 Inspection before Use

Before using the instrument, verify that it operates normally to ensure that no damage occurred during storage or shipping. If you find any damage, contact your authorized Hioki distributor or reseller.

Check items	Solution
Is the battery level sufficient?	Check the battery level indicator on the upper right corner while the power has been turned on. If  is blinking, the battery level is low. Replace the batteries with new ones. (p.25)
Is there any missing segment in the display items?	Check by activating the LCD all-on display. (p.57) If there is a missing segment, the device needs to be repaired.
Is there any damage or crack in the device?	Conduct visual checking. If damage is found, the device should not be used and needs to be repaired as it can cause electric shock.
Is there any foreign material (sand etc.) inside the measurement terminals?	Remove all foreign materials if any. If it cannot be removed, the device needs to be repaired.
Is there any damage or exposed internal white part or metal in the coating of measurement cable or test lead?	If damage is found, it should not be used and needs to be replaced as it can cause electric shock.

Check items	Solution
<p>Check for open circuit in measurement cable or test lead in the following method:</p> <ol style="list-style-type: none"> <ul style="list-style-type: none"> For three-pole method Press Fn button to display 3 POLE. For two-pole method Press Fn button to display 2 POLE. Connect measurement cables or test leads to the device and short-circuit their tips. Press MEASURE button to check that approx. 0 Ω is indicated. 	<p>If not indicating approx. 0 Ω</p> <ul style="list-style-type: none"> The measurement cables or test leads have not been fully inserted. →Fully insert the leads. The measurement cables or test leads may have an open circuit. →Replace it with another lead that is specified by Hioki. <p>If the symptom persists even after the measurement cables or test leads are replaced, the device may have a failure. The device needs to be repaired.</p>

2.5 Setting Up Comparator (PASS/FAIL Test)

The device has a comparator function, which can indicate PASS or FAIL with the display indicator and beep. The earth resistance can be measured without setting up the comparator.

The comparator function operates as follows:

Comparison result	Display	Buzzer sound
Measured value \leq Reference value (PASS)	PASS	Intermittent
Measured value $>$ Reference value (FAIL)	FAIL	Continuous

The comparison reference value can be chosen from the reference values in the following table.

Reference value (Ω)					
1	2	3	4	5	
6	7	8	9		
10	20	30	40	50	
60	70	80	90		
100*	200	300	400	500	OFF

*Default

How to set up comparator

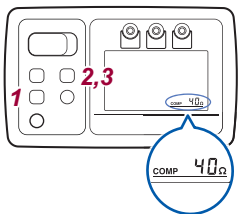

1 Press **Fn** button to set to **3 POLE** (three-pole method), or **2 POLE** (two-pole method).

2 Press **COMP** button.
COMP blinks, and the resistance for the comparison reference appears.

3 Press **COMP** button again and then choose a comparison reference.

If there is no operation for approx. 2 seconds after the desired comparison reference has been chosen, the comparator is enabled and **COMP** lights up in the display.

The comparator setting is saved even after the power is turned off.

How to disable comparator

1 Press **COMP** button while the comparator has been enabled.
COMP blinks.

2 Press **COMP** button and then select **[OFF]**.
If there is no operation for approx. 2 seconds, the comparator is disabled.

2.6 Precise Measurement for Earth Resistance (Precise Measurement Method, Three-pole Method)

WARNING



This device can output a voltage of approx. 30 V. Although the device has a dust-proof, jet-proof and water-proof structure, the device should always be dried before using it for measurement so as to avoid electric shock.

CAUTION



Do not connect the test leads if any foreign material remains inside. It may cause failure.

There are two types of measurement method for earth resistance: precision measurement method (three-pole method) and simplified measurement method (two-pole method), and the precision measurement method (three-pole method) is the basic measurement method for earth resistance.

The simplified measurement method is used when measurement cannot be performed by the precision measurement method.

The precision measurement is performed by inserting two auxiliary earthing rods into the ground as shown in the figure on p.38.

Measurement of large-scale earthing electrodes

When measuring a large-scale earthing electrode such as a mesh earthing electrode, ring earthing electrode, or earthing electrode provided by a large building structure, it cannot be accurately measured since the H(C) electrode and S(P) electrode come inside the earth resistance area of E electrode.

If long cables are used to avoid the H(C) electrode and S(P) electrode getting inside the earth resistance area, accurate measurement cannot be carried out as it is significantly affected by noise.

Generally, measurement of large-scale earthing electrode requires a large measurement current of approx. 20 A. Use measuring instrument designed for measuring large-scale earthing electrodes for this measurement. (No measuring instrument available for this purpose from Hioki)

Performing zero adjustment

Always perform zero adjustment prior to measurement.

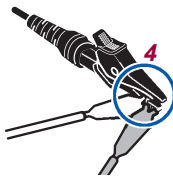
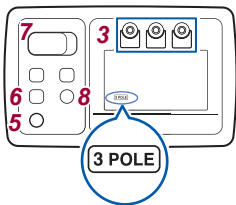
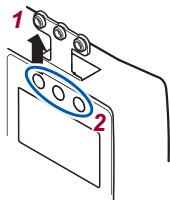

- 1 Remove the cover that protects the measurement terminals.
- 2 Make sure that no sand, gravels or small stones remain inside the measurement terminals.
- 3 Connect black, yellow and red measurement cables respectively to E, S(P) and H(C) terminals of the device.
- 4 Short-circuit the tips of the three measurement cables.
- 5 Press the  button to turn it on.

- 6 Press **Fn** button to display **3 POLE** (three-pole method).

Earth potential appears on the display.

- 7 Press **MEASURE** button.

A measured value of approx. 0Ω appears in approx. 8 seconds, and **HOLD** lights up.

When OPEN appears below the measurement terminal (), the measurement cable may not have been connected to a measurement terminal, or the cable may have an open circuit. Check the connection and perform cable check with a tester etc.

- 8 Press **0 Ω ADJ** button.

0 Ω ADJ lights up and then zero adjustment is completed.

If the measured value exceeds 3 Ω , [Err 1] appears and zero adjustment will not be executed. Zero adjustment settings will be saved even if the power is turned off.

How to disable zero adjustment

Hold down **0 Ω ADJ** button for at least one second, while **0 Ω ADJ** is on.

Connecting measurement cables

WARNING

- The maximum rated voltage between input terminals and the ground is as follows;
(CAT II): 300 V rms
(CAT III): 150 V rms
(CAT IV): 100 V rms
Attempting to measure voltages exceeding this level with respect to ground could damage the instrument and result in personal injury.
- To avoid electric shock, be careful to avoid shorting live lines with the test leads.



CAUTION



- To prevent cable damage, do not step on cables or pinch them between other objects. Do not bend or pull on cables at their base.
- The ends of the auxiliary earthing rod are sharp. Be careful to avoid injury.
- To ensure safe operation, use only the accessory cables.
- The cable is hardened under the 0 degree or colder environment. Do not bend or pull it to avoid tearing its shield or cutting cable.
- If the cable melts, the metal part may be exposed and can pose a hazard. Do not touch the area that is generating heat.

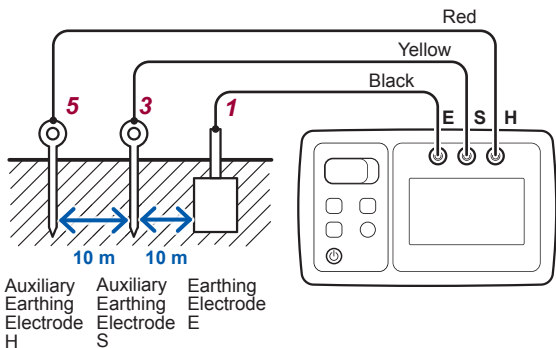

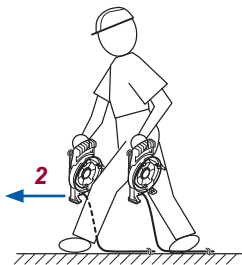

- 1** Use the measurement cable (black) to connect between earthing electrode and E terminal.
- 2** Carry two winders along to the measuring location while pulling out the measurement cables.
- 3** At the location where the measurement cable (yellow) has been fully pulled out, insert the auxiliary earthing rod into the ground and connect the measurement cable (yellow).
- 4** Carry the winder (measurement cable: red) along the straight line to a further distance between the earthing electrode E and auxiliary earthing electrode S while pulling out the measurement cable.
- 5** At the location where the measurement cable (red) has been fully pulled out, insert the auxiliary earthing rod into the ground and connect the measurement cable (red).

- Insert the auxiliary earthing rods into a moist layer in the ground. Since this device can accept a large resistance of auxiliary earthing electrode, the auxiliary earthing rods do not need to be inserted unnecessarily deep into the ground.
- For accurate measurement, the distance between E-S-H needs to be approx. 5 m. The measurement cables (yellow) and (red) should be positioned approx. 10 cm away from each other. Make sure the cables do not tangle or overlap together.

Measuring earth resistance

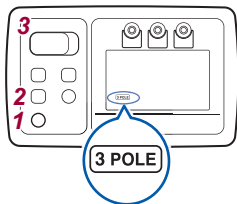

- 1 Press the **⏻** button to turn it on.
- 2 Press **Fn** button to display **3 POLE** (three-pole method).
Earth potential appears on the display.
- 3 Press **MEASURE** button so that the device automatically executes the earth potential check → auxiliary earth resistance check → earth resistance measurement in sequence.
The measurements will be completed in approx. 8 seconds, and then the measured value appears and **HOLD** lights up.
- 4 Check the measured value.

When NOISE Appears

If the earth potential is high (10 V rms or 14.3 Vpk or higher), **NOISE** and the earth potential peak value appears on the display. When **NOISE** is on, or when ⚡ (live wire warning indicator) is blinking, it is not possible to measure earth resistance. Since leak current is flowing into the earthing electrode, first disconnect any electric equipment connected to the earthing electrode and then press **MEASURE** button again.

- This device automatically detects AC/DC (\sim / \equiv) of the earth potential.
If AC/DC needs to be switched, it can be switched by pressing **DISPLAY** button while the current earth potential has been displayed.
- To check earth potential
After measurement of earth resistance, press **DISPLAY** button while **HOLD** is lit up so that the earth potential will be displayed.
When **HOLD** is lit up, press **Fn** button so that the retained value is unlocked and the current earth potential will be displayed.

When OPEN Appears

This device automatically check whether or not each earth resistance is within the allowable range by measuring the earth resistance of the auxiliary earthing rod prior to measuring the resistance of the earthing electrode E.

If the earth resistance of the auxiliary earthing electrode exceeds the allowable range, OPEN appears below the measurement terminal that exceeds the allowable range and the earth resistance of the earthing electrode E will not be measured.

Countermeasures when OPEN appears

Take the following actions for the auxiliary earthing rod connected with the measurement terminal for which OPEN appears.

- Pour water
- Stick in deeper
- Insert the auxiliary earthing rod into another location
- If the clip connecting point is dirty, wipe and clean the auxiliary earthing rod with a soft cloth.

DISPLAY button allows to display the earth resistance and earth potential of each earthing electrode.

RE	Earth resistance of earthing electrode E
RS	Earth resistance of auxiliary earthing electrode S
RH	Earth resistance of auxiliary earthing electrode H
V	Earth potential

When the resistance (R_H) of auxiliary earthing electrode exceeds 5 k Ω , the display range becomes the range of 200 Ω without displaying the digit of 0.01 Ω even though the resistance of earthing electrode is 20 Ω or less. The following table shows examples.

If the digit of 0.01 Ω is required, pour some water over the auxiliary earthing rod (H) to reduce the earth resistance to 5 k Ω or less.

Resistance R_H of auxiliary earthing electrode H	Example of indicated value (1) When 9.52 Ω is measured	Example of indicated value (2) When 13.48 Ω is measured
0 to 5 k Ω	9.52 Ω (Range: 20 Ω)	13.48 Ω (Range: 20 Ω)
5 k Ω to 50 k Ω	9.5 Ω (Range: 200 Ω)	13.5 Ω (Range: 200 Ω)

Stowing

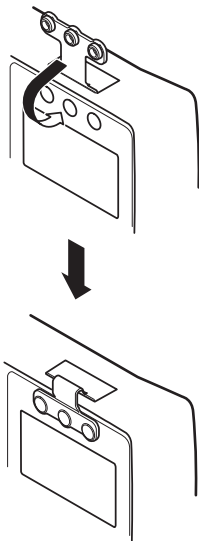

- 1** Press the  button to turn it off.
- 2** Remove the measurement cables from the measurement terminals and fit the cover of the measurement terminal.
- 3** Remove the measurement cables from the auxiliary earthing rods and pull out the auxiliary earthing rods without bending them. (See p.54 for how to pull out.)
- 4** Rewind the measurement cables (red, yellow) with the respective winders and stow the winders in the carrying case with the auxiliary earthing rods inserted into the winder's holders.
- 5** Remove the measurement cable (black) from the earthing electrode and fold it, and then stow it into the carrying case. (p.20)

Always fit the cover of the measurement terminals immediately after use. Any foreign object entering the measurement terminal may cause a failure.

Measurement on concrete

Since concrete is conductive, auxiliary earthing electrodes can be installed on concrete.

Place an auxiliary earthing rod on concrete and pour water over it, or cover the auxiliary earthing rod with a wet rag to form an auxiliary earthing electrode.

If the earth resistance of the auxiliary earthing electrode is not reduced by the above methods, place the optional 9050 earth net on concrete and then position the auxiliary earthing rod on the earth net and pour water over it. Before measurement, allow some time for the water to well soak into the concrete.

As an alternative to the earth net, a metal plate or aluminum foil etc. may be used. However, the earth net will provide better reduction in the earth resistance of auxiliary earthing electrode.

Since asphalt is insulator, it is generally not possible to install the auxiliary earthing electrode on asphalt. However, measurement may be possible on asphalt that has water permeability.

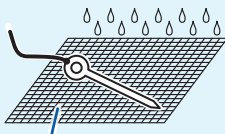

9050 Earth Nets

2.7 Simplified Measurement for Earth Resistance (Simplified Measurement Method, Two-pole Method)

DANGER



- Use the neutral side (ground side) of the commercial power supply for this measurement. Prior to connection, use a voltage detector etc. to make sure that it is going to be connected with the neutral side and take caution for electric shock.
- This device can be connected to the neutral side of an outlet with a voltage-to-ground of 300 V or less, or to the wire on the neutral side of the breaker's secondary side with a voltage-to-ground of 150 V or less. Do not connect with anything other than those specified above. It can be hazardous.

WARNING



- Use the optional test lead L9787 for simplified measurement for safety. Connecting the measurement cables L9841, L9842-11, L9842-22, L9843-51 and L9843-52 to a commercial power supply may cause electric shock.
- This device can output a voltage of approx. 30 V. Although the device has a dust-proof, jet-proof and water-proof structure, the device should always be dried before using it for measurement so as to avoid electric shock.

CAUTION

- When the device is set to two-pole method, even if it is connected to the earth side of a commercial power supply, it will not trigger the earth leakage breaker since the measurement current is suppressed to 4 mA or less. However, do not use this method for measurement at a location where an earth leakage breaker or leakage relay with the current sensitivity of less than 10 mA has been installed, since such an earth leakage breaker or leakage relay may be triggered.
- The simplified measurement function of this device is a function for measuring earth resistance with small inductance component. Therefore, a resistor connected in series with inductance component of 3 mH or more may not be accurately measured.
- Removable sleeves are attached to the metal pins at the ends of the test leads. To prevent a short circuit accident, be sure to use the test leads with the sleeves attached when performing measurements in the CAT III measurement category. For the measurement categories, see “Measurement categories” (p.7).
- If the sleeves are inadvertently removed during measurement, stop the measurement.
- When carrying out measurements with the sleeves in place, be careful to avoid damaging the sleeves. If the cover cap accidentally comes off during measurement, it should be handled carefully to avoid electric shock.
- Since the tip of the metal pin is sharp, care needs to be taken to avoid injury.
- L9787 is a test lead specifically designed for indoor use. Do not use it outdoor.



Removing and attaching the sleeves of L9787 Test lead

- **Removing the sleeves**

Gently hold the bottom of the sleeves and pull the sleeves off.
Safely store the removed sleeves so as not to lose them.

- **Attaching the sleeves**

Insert the metal pins of the test leads into the holes of the sleeves, and firmly push them all the way in.

What is simplified measurement method (two-pole method)?

Simplified measurement method (two-pole method) is a measurement method to check the earth resistance of the equipment earthing with an earth system called TT method.

In case of not being able to insert an auxiliary earthing rod, the earth resistance is obtained with use of an existing low earthing resistor as an auxiliary electrode.

In this method, the measured value is the sum ($R_x + R_o$) of the earth resistances of the measuring object and existing earthing resistor, according to the measurement principle. Therefore, the earth resistance of the existing earthing resistor used needs to be lower than that of the earthing electrode of the measuring object.

In the simplified measurement method, the resistance of the earthing element used is added to the measurement result.

It is very difficult to measure 10Ω or less in the simplified method.

Performing zero adjustment

The range that this device can provide zero adjustment for is 3Ω or less. If the measured value exceeds 3Ω , [Err 1] appears and zero adjustment will not be executed.

Simplified Measurement for Earth Resistance
(Simplified Measurement Method, Two-pole Method)

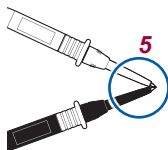
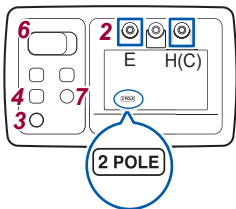
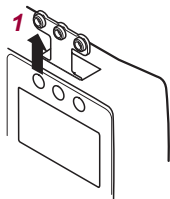

- 1 Remove the cover of the measurement terminals.
- 2 Connect the E terminal and H(C) terminal of this device respectively with the L9787 test lead (black) and L9787 test lead (red).

3 Press the  button to turn it on.

- 4 Press **Fn** button to display **2 POLE** (two-pole method).

A measured value (approx. 0 V) of the earth potential appears.

- 5 Connect (short-circuit) the tips of test leads.

- 6 Press **MEASURE** button.

A measured value of approx. 0 Ω appears in approx. 3 seconds, and **HOLD** lights up.

When **OPEN** appears below the measurement terminal, a test lead may not have been connected to the measurement terminal, or the lead may have an open circuit. Check the connection and perform cable check with a tester etc.

- 7 Pressing **0 Ω ADJ** button will turn **0 Ω ADJ** on and complete zero adjustment.

How to disable zero adjustment

Hold down **0 Ω ADJ** button while **0 Ω ADJ** is on.

Connecting test leads

WARNING



- Do not use this device for measuring the voltage of commercial power supply.



- If there is a large voltage on the neutral side, ⚡ (live wire warning indicator) blinks and beep sound goes off. Immediately remove the test leads from the commercial power supply.
- If the earth potential is high, attention needs to be paid for the risk of electric shock.

The figure below shows an example of connection in the case of using a commercial power supply that is grounded on its N (neutral) side.

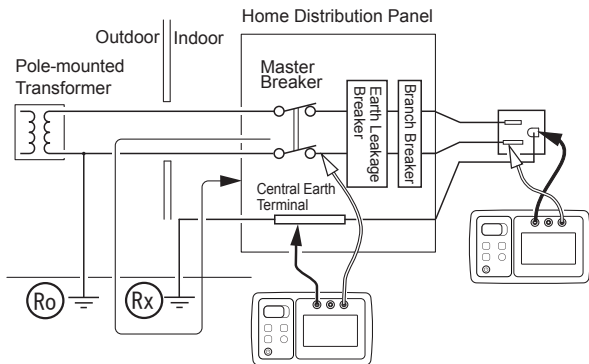

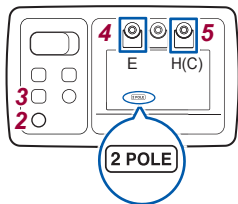
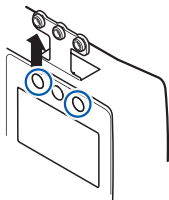

- 1 Use a voltage detector etc. to make sure that there is no voltage on the N (neutral) side of commercial power supply.
- 2 Press the  button to turn it on.
- 3 Press **Fn** button to display **2 POLE** (two-pole method).

When **3 POLE** (three-pole method) is chosen, the earth leakage breaker etc. may be triggered due to its large measurement current.

- 4 Connect the L9787 test lead (black) with the earthing electrode of measuring object.
- 5 Connect the L9787 test lead (red) with the N (neutral) side of commercial power supply.
Earth potential appears on the display.

- When **NOISE** appears, a large earth potential (10 V rms or 14.3 Vpk or higher) exists between the earth and the N (neutral) side of commercial power supply. A large leak current may be flowing through the earthing electrode of the measuring object or through the earthing element of the commercial power supply used for measurement. Therefore, conduct an insulation resistance test or leakage current test etc. In addition, disconnect any electric equipment from the earthing electrode.
- This device automatically detects AC/DC of the earth potential.
- If AC/DC needs to be switched during earth potential measurement, it can be switched by pressing **DISPLAY** button.
- After measurement of earth resistance, press **DISPLAY** button while **HOLD** is lit up so that the earth potential will be displayed.
When **HOLD** is lit up, press **Fn** button so that the retained value is unlocked and the current earth potential will be displayed.
- When **NOISE** is on, or when ⚡ (live wire warning indicator) is blinking, it is not possible to execute earth resistance measurement.

Measuring earth resistance

Press **MEASURE** button so that the device automatically executes the following measurements in sequence. The measured value appears in approx. 3 seconds and **HOLD** lights up.

- 1 Check earth potential.**
Check whether or not the peak value of the earth potential is within the allowable range.
- 2 Measure earth resistance.**
Measure the sum ($R_x + R_o$) of the earth resistance of earthing electrode and the earth resistance on the neutral side of commercial power supply.

Stowing

- 1 Press the \odot button to turn it off for safety.**
- 2 Remove the test leads from the measurement terminals and fit the cover of the measurement terminal. (p.42)**
- 3 Fold the test leads together and stow it into the carrying case.**

2.8 Cautions and Tips for Measurement

Distance between earthing electrodes

When the distance between E-H(C) is 1 m as shown in Figure (a), if the resistance of the earthing element E is measured while changing the distance x m between the electrodes E-S(P), measurement results such as shown in (b) are obtained.

Therefore, its error becomes greater as the location of the auxiliary earthing rod S(P) moves closer to the earthing element E or auxiliary earthing rod H(C).

In addition, if the distance between the electrodes E-H(C) is short, the measurement error is greater as the earth resistance under test (R_x) and the earth resistance of auxiliary earthing rod (R_c) cannot be separated from each other.

If earthing is provided by a building structure etc. in a large area, the resistance area indicated in (a) becomes very wide.

In order to carry out accurate measurement, the auxiliary earthing rods (S(P) and H(C)) need to be installed at a location well away from the earthing element (R_x).

As to confirm the above, carry out measurements at several locations while moving the location of the auxiliary earthing rod S(P) from the earthing element (R_x) to the auxiliary earthing rod H(C) and check whether or not there is an almost flat section shown in (b) in the measured resistance even though the auxiliary earthing rod S(P) has been moved.

If no flat section is seen, the measurement distance is insufficient. Move the installation locations of the auxiliary earthing rods (S(P) and H(C)) to further locations.

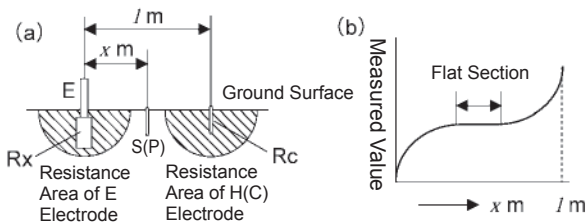

The distance between E-H(C) of this device can be up to 50 m by using the optional L9843-51 and L9843-52. In principle, it is possible to carry out measurement even if the distance is more than 50 m. However, the measurement result cannot be guaranteed.

Location to install auxiliary earthing rod

It is ideal to install the auxiliary earthing rod S(P) at the middle point of the straight line between the earthing electrode E and auxiliary earthing rod H(C).

However, if installation is not possible due to an obstacle etc., the measurement error can be reduced by installing the auxiliary earthing rod (S(P)) within 29° from the straight line between the earthing electrode E and auxiliary earthing rod H(C), wherein the location should be outside the radius of 5 m from the earthing element E and auxiliary earthing rod H(C) as shown in the figure.

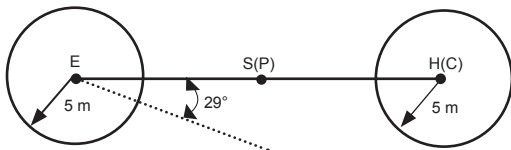

How to insert / pull out auxiliary earthing rod

How to Insert

The accessory auxiliary earthing rods are suitable for providing auxiliary earthing electrodes and are designed for thickness and hardness that allow insertion into a general ground by hand. Since it is skinnier than conventional models, it can be inserted into a small gap.

When inserting the rod, wear gloves and insert it perpendicular to the ground surface.

If the ground is too hard for inserting by hand, use a hammer to perpendicularly drive into the ground. Hammering the auxiliary earthing rod too hard may result in bending it. In case of not going into the ground with gentle taps, use the optional 9050 earth net for measurement.

How to Pull Out

- Hold the loop part of the auxiliary earthing rod and pull it out while turning it.

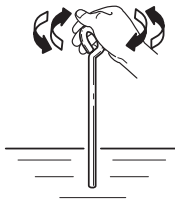

- If it does not come out by hand, put a hard metal bar etc. (other than auxiliary earthing rod) through the loop part of the auxiliary earthing rod and pull the auxiliary earthing rod while turning it.

If pulling the auxiliary earthing rod with another auxiliary earthing rod put through the loop, it will result in bending it.

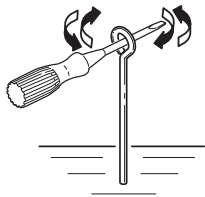

- Do not apply force to the auxiliary earthing rod from the side as it may result in bending the auxiliary earthing rod.

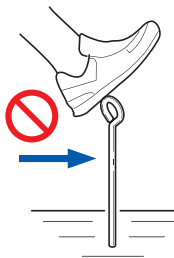

2.9 Auto Power Save (Power-saving Function)

Approx. 10 min after the last operation or the last time ⚡ (live wire warning indicator) turns on or blinks, the auto power save becomes active and the screen turns off.

How to recover from auto power save

Press the ☺ button to turn the screen on.

How to disable auto power save

Turn the power on while pressing **0ΩADJ** button.

The settings of an disabled auto power save will not be saved when the power is turned off.

2.10 Activating the LCD All-on Display

- 1 Turn the power on while pressing **DISPLAY** button.

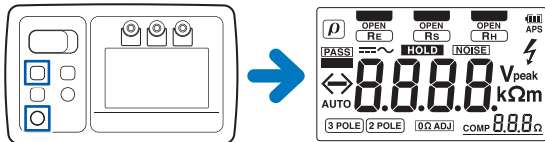

- 2 If any button is pressed, its normal measurement screen will appear.

2.11 Displaying the Serial number

Turn the power on while pressing **Fn** button.

The first 4 digits and the last 5 digits of the serial number (9 digits) appear alternately.

If any button is pressed, its normal measurement screen will appear.



First 4 digits

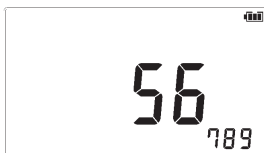

Last 5 digits

(Example of a serial number: 123456789)

3

Specification

3.1 General Specification

Product warranty period	3 years
Guaranteed accuracy period	1 year
Nominal range of use Operating temperature and humidity	-10°C to 40°C (14°F to 104°F): 80%RH or less (non-condensing) 40°C to 45°C (104°F to 113°F): 60%RH or less (non-condensing) 45°C to 50°C (113°F to 122°F): 50%RH or less (non-condensing) 50°C to 55°C (122°F to 131°F): 40%RH or less (non-condensing)
Position	Level $\pm 90^\circ$
Power supply voltage	Available effective battery voltage
Earth potential	Refer to: "Allowable earth potential" (p.63)
Resistance of auxiliary earthing electrode	Refer to: "Allowable resistance of auxiliary earthing electrode" (p.62)
External magnetic field	400 A/m or less, DC and frequency 50/60 Hz
Storage temperature and humidity	-20°C to 60°C (-4°F to 140°F): 80%RH or less (non-condensing)
Operating environment (scope of application)	Indoor, outdoor (excluding farmland*), pollution degree 3, altitude up to 2,000 m (6,562-ft.) * According to the requirements regarding the regulations for open-circuit voltage in EN 61557-5
Power source	LR6 Alkaline battery $\times 4$
Rated power supply voltage	1.5V DC $\times 4$
Maximum rated power	3 VA
Available effective battery voltage	4.5 V ± 0.19 V to 6.8 V

Possible number of measurements	400 times (measurement conditions: three-pole method, auxiliary earthing electrode resistance 100 Ω, measure 10 Ω with the range of 20 Ω, measure at 10 seconds interval)
IP protection code	IP65/IP67 (EN 60529)
Drop-proof	1 m above concrete (with protector attached)
Maximum rated voltage between input terminals and the ground	100 V AC/DC (measurement category IV) 150 V AC/DC (measurement category III) 300 V AC/DC (measurement category II) anticipated transient overvoltage 2500 V
Withstand voltage	3510 V, 50/60 Hz, between measurement terminals (together) and case, for 15 seconds, sensed current 1 mA
Dimensions	Approx. 185 W × 111 H × 44 D mm (7.28" W × 4.37" H × 1.73" D) (including protector, excluding terminal covers)
Mass	Approx. 570 g (20.1 oz.) (including batteries and protector, excluding other accessories)
Accessories	Refer to: "Verifying Package Contents" (p.1)
Options	Refer to: "Options (sold separately)" (p.2)
Applicable standards	Safety Device : EN 61010 Measuring circuit : EN 61010 EMC : EN 61326 Earth tester : EN 61557

3.2 Measurement Function/Performance

Temperature and humidity: 23°C ± 5°C (73°F ± 9°F), 80%RH or less

Measurement of earth resistance

(auxiliary earthing electrode resistance 100 Ω±5%, earth potential 0 V)

R_E : Earth resistance of measuring object, R_H : Earth resistance of H electrode, R_S : Earth resistance of S electrode

Operation system	Voltage application, measurement of voltage and current (effective resistance is measured by synchronous detection)
Measurement system	Two-pole method / three-pole method, switchable
Output voltage	AC without DC component
Open-circuit voltage	30 V rms or less and 42.43 Vpk or less
Measurement current	Three-pole method: 25 mA rms or less Two-pole method: 4 mA rms or less
Measurement current waveform	Sine wave
Measuring frequency	128 Hz ±2 Hz
Measuring time	Three-pole method: Within 8 seconds Two-pole method: Within 3 seconds

Range configuration (auto range)	Display range ^{*1}		20 Ω ^{*2}	200 Ω	2000 Ω
	Applied conditions (R _E and R _H)	R _E	20 Ω or less	200 Ω or less	200 Ω to 2 kΩ or less
		R _H	5 kΩ or less	50 kΩ or less	50 kΩ or less
	Display range		0 to 20.00 Ω	0 to 200.0 Ω	200 to 2000 Ω
	Resolution	3-pole	0.01 Ω	0.1 Ω	1 Ω
		2-pole	—	1 Ω	1 Ω
	Accuracy ^{*3} (specific uncertainty A)		±1.5 %rdg. ±8 dgt.	±1.5 %rdg. ±4 dgt.	
	Allowable resistance of auxiliary earthing electrode	R _H	5 kΩ	50 kΩ	
		R _S	5 kΩ	50 kΩ	
	Operation uncertainty		±30%rdg. (applied to three-pole method)		
Guaranteed range of operation uncertainty ^{*4}		5.00 to 2000 Ω			
Effect of positioning (E₁)	Not applicable due to digital type				
Effect of supply voltage (E₂)	Accuracy × 0.5 and within accuracy				
Effect of temperature (E₃)^{*5}	Accuracy × 1.0 (-10°C to 50°C) Accuracy × 2.0 (50°C to 55°C)				
Effect of earth potential (E₄)	50 Hz, 60 Hz	0 to 3 V		Accuracy × 1.0	
		3 to 10 V		Accuracy × 2.0	
	DC, 16 2/3 Hz, 400 Hz	0 to 3 V		Accuracy × 1.0	

Allowable earth potential	10 V rms (DC or sine wave)				
Effect of the resistance of auxiliary earthing electrode (E_5)	Either R_H or R_S electrode	Variable value			
	10 k Ω or less	Accuracy \times 1.0			
	Above 10 k Ω to 50 k Ω	Accuracy \times 2.0			
Effect of system frequency (E_7)	Not applicable				
Effect of system voltage (E_8)	Not applicable				
Effect of external magnetic field	Accuracy \times 0.5				
Earth resistance of auxiliary earthing electrode auto-check (auto-check after start of measurement)	Display range	1000 Ω	10 k Ω	100 k Ω	200 k Ω
	Maximum display value	1000 Ω	10.0 k Ω	100 k Ω	200 k Ω
	Resolution	10 Ω	0.1 k Ω	1 k Ω	10 k Ω
	Accuracy	Not specified			
Auto-check for earth potential⁶ (auto-check after start of measurement)	Display range	42 Vpk			
	Maximum display value	42.0 Vpk			
	Accuracy	\pm 2.3 %rdg. \pm 8 dgt.			
Overload protection	360 V AC (for 1 min, between each terminal)				
	360 V DC (for 1 min, between each terminal)				
Effect of earth capacity (two-pole method)	Up to 10 nF	Within accuracy specification			
	Above 10 nF to 500 nF	Accuracy \times 2.0			
	Above 500 nF	Not specified			

Zero adjustment allowable range	3 Ω or less
--	--------------------

- *1 Automatically select the minimum display range that can meet both R_E and R_H values.
- *2 Three-pole method only.
- *3 Applied after zero adjustment, $\pm 0.3 \Omega$ is added before zero adjustment (with use of L9481).
- *4 It shall be the range in which the operation uncertainty within $\pm 30\%$ is guaranteed; applied to three-pole method.
- *5 Applied in the range excluding 18 to 28°C.
- *6 Function to check whether or not the peak of earth potential is within the allowable range; no AC coupling; display the peak value (peak on + side).

Earth potential measurement	
DC/AC auto-detection range	0.3 V DC \pm 0.2 V or higher is detected as DC Manual switching function provided Pulsating flow with superimposed AC component that periodically zero-crosses is detected as AC
Measurement system	Average value rectification effective value indication
Terminal for voltage measurement	Three-pole method: Between S terminal (+) — E terminal (-) Two-pole method: Between H terminal (+) — E terminal (-)
Overload protection	360 V AC for 1 min 360 V DC for 1 min
Display refresh interval	Within 1 second
Input resistance	4 M Ω or higher (DC / 50 Hz / 60 Hz)
Response time	Within 2 seconds (when input voltage is changed from 0 V to 30 V)

Effect of temperature	Accuracy \times 1.0 (applied in the range excluding 18 to 28°C)	
Range configuration	Display range	30 V rms
	Maximum display value	30.0 V rms
	Resolution	0.1 V
	Accuracy	DC
50 / 60 Hz		± 2.3 %rdg. ± 8 dgt.

4

Maintenance and Service

4.1 Repair, Inspection, and Cleaning

DANGER



Customers are not allowed to modify, disassemble, or repair the instrument.

Doing so may cause fire, electric shock, or injury.

Calibrations

IMPORTANT

Periodic calibration is necessary in order to ensure that the instrument provides correct measurement results of the specified accuracy.

The calibration frequency varies depending on the status of the instrument or installation environment. We recommend that the calibration frequency is determined in accordance with the status of the instrument or installation environment and that you request that calibration be performed periodically.

Cleaning

- To clean the instrument, wipe it gently with a soft cloth moistened with water or mild detergent.
When rinsing with water, make sure that the battery cover has been attached. Make sure that the protector has been removed and rinse with room-temperature water.
- After cleaning, thoroughly wipe off water of the device and protector. Completely dry them before putting the protector on.
- Rinse with room-temperature water. If rinsing with hot water, the waterproof performance may be impaired.
- Do not put water while the battery cover has been taken off. It may cause failure due to water intrusion.

- When replacing the batteries after cleaning, the replacement should be carried out after the device has been completely dried.
- This device is waterproof to a water depth of 1 m for 30 min. Do not soak and wash the device. Do not soak the device into hot water.
- Do not wash the device with a washing machine.
- Do not use any electronic appliance such as a dryer or microwave for drying this device.
- Wipe the LCD gently with a soft, dry cloth.

IMPORTANT

Never use solvents such as benzene, alcohol, acetone, ether, ketones, thinners or gasoline, as they can deform and discolor the case.

If the instrument is not to be used for an extended period of time

IMPORTANT

To avoid corrosion from battery leakage and/or damage to the instrument, remove the batteries from the instrument if it is to be kept in storage for an extended period.

Disposal

Handle and dispose of the instrument in accordance with local regulations.

Protector

A protector is available as a service part. Contact your authorized Hioki distributor or reseller.

4.2 Troubleshooting

- When a malfunction of the instrument is suspected, check the information in “Before sending the instrument for repair” (p.70) and then, if necessary, contact your authorized Hioki distributor or reseller.
- Pack the instrument so that it will not sustain damage during shipping, and include a description of existing damage. We do not take any responsibility for damage incurred during shipping.
- When sending the instrument for repair, remove the batteries and pack carefully to prevent damage in transit. Include cushioning material so the instrument cannot move within the package. Be sure to include details of the problem. Hioki cannot be responsible for damage that occurs during shipment.
Reference: “Precautions during shipment” (p.11)

IMPORTANT

The 4 screws that secure the upper and lower cases in the underside of the device have a special shape. Do not unscrew the screws with a tool other than the specialized tool as the screws may be damaged if trying to unscrew them with a tool other than the specialized tool, making it impossible to carry out repair.

Before sending the instrument for repair

If it is not operating correctly, check the following items.

Symptom	Cause, check, countermeasure
<p>The power does not turn on.</p>	<p>There are no batteries inside. The batteries have been incorrectly installed.</p> <p>→Refer to how to install the batteries. Have the batteries been depleted?</p> <p>→Replace the batteries with new ones. If the power still will not turn on, the device has a failure and needs to be repaired. (p.25)</p>
<p>The resistance of auxiliary earthing electrode does not come down (precision measurement).</p>	<p>Bad connection of measurement cable, the ground is dry.</p> <p>→Make sure that the measurement cables are connected to the earthing electrode/auxiliary earthing rod.</p> <p>→Short-circuit the tips of the measurement cables and then carry out the measurement. If the measured value is approx. 0 Ω, it is caused by a high earth resistance of the earthing electrode. Insert the auxiliary earthing rod deeper. Alternatively, pour water over the auxiliary earthing rod. If the resistance still will not come down, move the auxiliary earthing electrode to another location.</p> <p>The measurement cables (yellow) and (red) should be positioned approx. 10 cm away from each other.</p>

Symptom	Cause, check, countermeasure
<p>NOISE appears and measurement is not allowed (cannot measure the earth resistance due to high earth potential).</p>	<p>The earth potential exceeds the value that can be accepted by this device. A large leakage current may be flowing into the earthing electrode from equipment that has been connected to the earthing electrode. Or, the earth resistance of earthing electrode may be high and a large earth potential may have occurred by a small leakage current.</p> <p>→Remove the equipment that has been connected to the earthing electrode and then carry out the measurement. (p.39)</p>
<p>Trying to carry out measurement on a newly built residential building, but the simplified measurement (two-pole method) is not allowed.</p>	<p>Measurement is not allowed if the electricity has not been distributed from the power company.</p>
<p>The measured value becomes approx. 0 Ω when measuring with use of an existing auxiliary earthing electrode for measurement.</p>	<p>The earthing electrode and the auxiliary electrode for measurement may have been connected through concrete.</p> <p>→Drive an auxiliary earthing rod into the ground and then carry out measurement instead of using an auxiliary electrode for measurement.</p>
<p>Small noise occurs inside the device during measurement.</p>	<p>It is the noise from the oscillator circuit inside the device. It is not a failure.</p>
<p>The measured value is high.</p>	<p>It has been set to two-pole method.</p> <p>→Press Fn button to select three-pole method.</p>
<p>Measurement is not allowed when trying to measure with an earth net laid on asphalt.</p>	<p>Since asphalt is insulator, measurement is not possible with an earth net.</p>

Symptom	Cause, check, countermeasure
Auxiliary earthing rod has been bent.	It is recommended to purchase the L9840 Auxiliary Earthing Rod. (Commercially available pegs have sharp tips, which may damage the carrying case.)

4.3 Error Display

Error display	Description	Solution
Err1	Zero adjustment is outside the allowable range, zero adjustment has been executed while it is not on HOLD.	Execute zero adjustment again in accordance with the zero adjustment procedure. (p. 35, p. 46)
Err2	Abnormality in setting data	Device failure. Contact your authorized Hioki distributor or reseller to organize repair.
Err3	Adjustment data damaged	
Err4	Adjustment data not yet written	
Err5	Abnormality in measurement circuit	
Err6	Abnormality in firmware	

Appendix 1 Earth Resistance

The resistance between earthing electrode and ground is usually called earth resistance. To be exact, it is the sum of the resistance of earthing conductor, the contact resistance between earthing conductor and ground, and the resistance of ground.

Earth resistance is different from commonly known resistors and has the following special characteristics.

- **Polarizing action**

Since the ground has characteristics just like electrolyte, it has the polarizing action, and if DC current flows through, an electromotive force occurs in the opposite direction to the current, interfering with correct measurement. Therefore, rectangular wave or sine wave of several tens Hz to 1 kHz is usually used to measure the earth resistance.

- **Special configuration**

Earth resistance is a resistance between earthing electrode and ground. It is not possible to take it out from the ground and measure it.

Since the resistivity of ground is relatively high, a voltage drop occurs near the electrode through which the current to be measured flows. Therefore, each electrode (E electrode, S(P) electrode, H(C) electrode) needs to be away from each other to approx. 10 m to accurately measure the resistance of earthing electrode.

- **Presence of disturbance factors**

There are disturbance factors such as effects from earth potential and auxiliary earthing electrode in the measurement of earth resistance.

The earth potential caused by a leakage current from a device that has been connected to the earthing electrode affects the measured value as it is superimposed over the signal to be

detected by the earth tester. In addition, if the earth resistance of auxiliary earthing electrode is high, the measurement current is reduced, making it susceptible to noise such as earth potential. This device employs a system that is less susceptible to these disturbances and allows accurate measurement under adverse conditions.

Appendix 2 Measurement Principle

While applying a voltage of AC power supply between H(C) electrode and E electrode, the flowing AC current I is measured with an ammeter. In addition, the voltage V between S(P) electrode and E electrode that is caused by the flow of the current I is measured by an AC voltmeter.

The earth resistance R_x of E electrode is derived from the measured current I and voltage V . It is not possible to accurately measure the voltages between H(C) - E electrodes and between H(C) - S(P) electrodes.

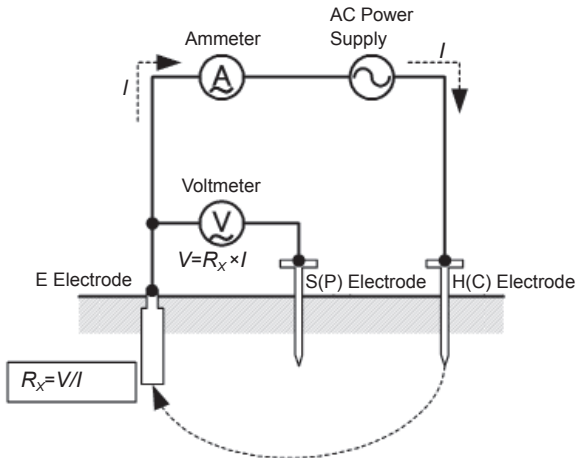

Warranty Certificate

Model	Serial No.	Warranty period Three (3) years from date of purchase (__ / __)
<p>This product passed a rigorous inspection process at Hioki before being shipped.</p> <p>In the unlikely event that you experience an issue during use, please contact the distributor from which you purchased the product, which will be repaired free of charge subject to the provisions of this Warranty Certificate. This warranty is valid for a period of three (3) years from the date of purchase. If the date of purchase is unknown, the warranty is considered valid for a period of three (3) years from the product's date of manufacture. Please present this Warranty Certificate when contacting the distributor. Accuracy is guaranteed for the duration of the separately indicated guaranteed accuracy period.</p> <ol style="list-style-type: none">1. Malfunctions occurring during the warranty period under conditions of normal use in conformity with the Instruction Manual, product labeling (including stamped markings), and other precautionary information will be repaired free of charge, up to the original purchase price. Hioki reserves the right to decline to offer repair, calibration, and other services for reasons that include, but are not limited to, passage of time since the product's manufacture, discontinuation of production of parts, or unforeseen circumstances.2. Malfunctions that are determined by Hioki to have occurred under one or more of the following conditions are considered to be outside the scope of warranty coverage, even if the event in question occurs during the warranty period:<ol style="list-style-type: none">a. Damage to objects under measurement or other secondary or tertiary damage caused by use of the product or its measurement resultsb. Malfunctions caused by improper handling or use of the product in a manner that does not conform with the provisions of the Instruction Manualc. Malfunctions or damage caused by repair, adjustment, or modification of the product by a company, organization, or individual not approved by Hiokid. Consumption of product parts, including as described in the Instruction Manuale. Malfunctions or damage caused by transport, dropping, or other handling of the product after purchasef. Changes in the product's appearance (scratches on its enclosure, etc.)g. Malfunctions or damage caused by fire, wind or flood damage, earthquakes, lightning, power supply anomalies (including voltage, frequency, etc.), war or civil disturbances, radioactive contamination, or other acts of Godh. Damage caused by connecting the product to a networki. Failure to present this Warranty Certificatej. Failure to notify Hioki in advance if used in special embedded applications (space equipment, aviation equipment, nuclear power equipment, life-critical medical equipment or vehicle control equipment, etc.)k. Other malfunctions for which Hioki is not deemed to be responsible <p>*Requests</p> <ul style="list-style-type: none">• Hioki is not able to reissue this Warranty Certificate, so please store it carefully.• Please fill in the model, serial number, and date of purchase on this form.		
HIOKI E.E. CORPORATION 81 Koizumi, Ueda, Nagano 386-1192, Japan TEL: +81-268-28-0555 FAX: +81-268-28-0559		13-09

- For regional contact information, please go to our website at <http://www.hioki.com>.
- The Declaration of Conformity for instruments that comply to CE mark requirements may be downloaded from the Hioki website.
- All reasonable care has been taken in the production of this manual, but if you find any points which are unclear or in error, please contact your supplier or the International Sales and Marketing Department at Hioki headquarters.
- In the interests of product development, the contents of this manual are subject to revision without prior notice.
- The content of this manual is protected by copyright.
No reproduction, duplication or modification of the content is permitted without the authorization of Hioki E.E. Corporation.

HIOKI

HIOKI E. E. CORPORATION

Headquarters

81 Koizumi, Ueda, Nagano 386-1192, Japan
TEL +81-268-28-0562 FAX +81-268-28-0568
E-mail: os-com@hioki.co.jp

URL <http://www.hioki.com/>
(International Sales and Marketing Department)

HIOKI USA CORPORATION

E-mail: hioki@hiokiusa.com URL <http://www.hiokiusa.com>

HIOKI (Shanghai) Sales & Trading Co., Ltd.

E-mail: info@hioki.com.cn URL <http://www.hioki.cn>

HIOKI INDIA PRIVATE LIMITED

E-mail: hioki@hioki.in URL <http://www.hioki.in>

HIOKI SINGAPORE PTE. LTD.

E-mail: info@hioki.com.sg

1305