

A GREATER MEASURE OF CONFIDENCE

KEITHLEY
A Tektronix Company



Source Measure Unit Instruments

The Tool of Choice for Emerging R&D Applications



What is a Source Measure Unit (SMU) Instrument?

A source measure unit (SMU) instrument is a type of test equipment that is capable of both sourcing and measuring simultaneously to a device under test (DUT.)



SMU instruments are a smart alternative to separate power supplies and digital multimeters (DMMs,) and they have a convenient DMM-like user interface. Keithley SMU instruments combine a power supply, true current source, 6.5-digit DMM, arbitrary waveform generator, V or I pulse generator with measurement, electronic load, and trigger controller – all in one instrument.

SMU instruments can:

- Simultaneously source voltage or current and measure voltage and/or current
- Source and measure across 10 decades of current and 5 decades of voltage
- Perform resistance measurements using programmable force voltage or force current values

SMU instruments are typically used on an R&D bench or in automatic test systems in both labs and manufacturing operations to perform IV characterization.

Meet Keithley's Entire SourceMeter SMU Instrument Family



What is an SMU instrument and how do you decide which one is right for your application?
[Download the white paper now to find out.](#)

Want assistance, a quote, or to place an order?
[Contact us online.](#)

- Join the discussion on our [application forum.](#)

SMU Instruments vs. DMMs and Power Supplies

Virtually every digital multimeter (DMM) includes some basic SMU instrument concept in its ohms function, where a built-in, fixed, current source is applied to the unknown resistance, the voltage developed across it is measured, and the resistance value is then calculated using Ohm's Law ($R = E/I$). A Keithley SourceMeter SMU instrument takes the concept to a much higher level of flexibility for characterizing, evaluating, and testing a wider range of devices over a much wider range of applied stimulus, either current or voltage.

A SourceMeter SMU instrument has a four-quadrant, precision source, which means it can source current or voltage depending on the settings and load and can go from maximum positive output to maximum negative output without changing test leads. Four-quadrant capability also means the SourceMeter SMU instrument can "sink" current, as when taking current from a device under test (DUT) such as a solar cell, charged capacitor, or power supply, where the SourceMeter SMU instrument acts as a precision, controlled load, with the resulting DUT voltage being measured at the same time.

One of the simplest applications for a SourceMeter SMU instrument is in testing diodes, where a series of constant current or voltage steps (sweep) is applied to test the forward characteristics and a sweep of constant voltage is typically used to test the reverse leakage and breakdown parameters.

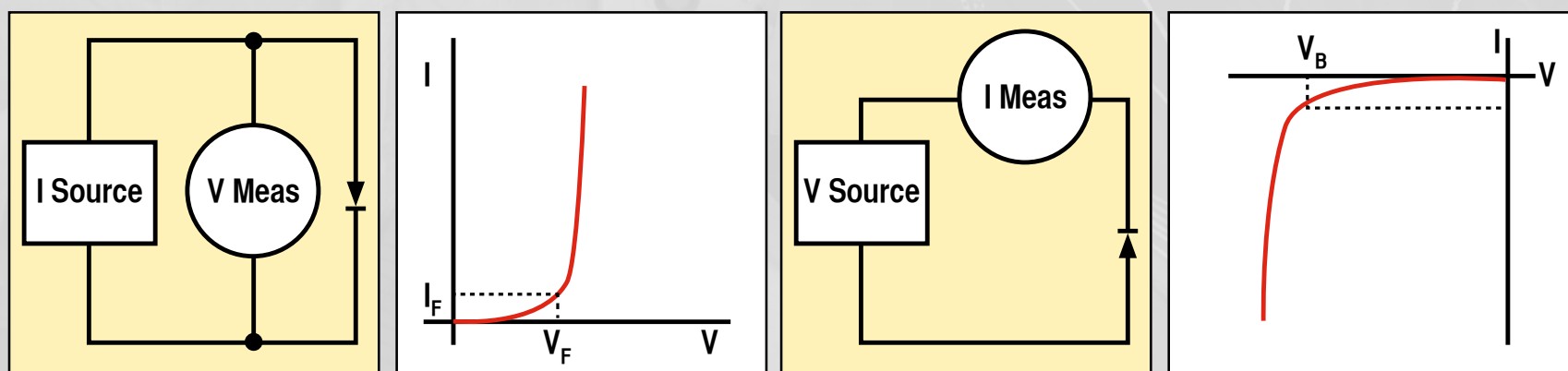
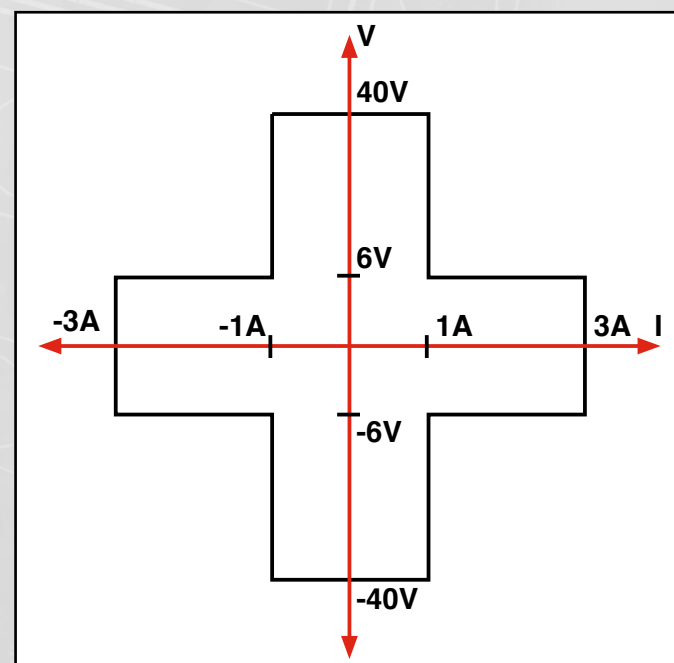

View a short introduction of the **NEW** Model 2450 Advanced Touchscreen SourceMeter SMU Instrument.

Want assistance, a quote, or to place an order?
[Contact us online.](#)

■ Join the discussion on our [application forum.](#)

Choosing the Keithley SourceMeter® SMU Instrument for Your Application

Keithley has three SourceMeter SMU Instrument families, the Series 2400, the Series 2600B, and the NEW 2450 Touchscreen SourceMeter SMU instrument. Series 2400 and 2450 SourceMeter SMU instruments are ideal for lab/bench R&D applications. These models are single channel only and have a DMM and power supply look and feel.

[Learn more about the Model 2450 Touchscreen SourceMeter® SMU instrument](#)

[Learn more about the Series 2400 SourceMeter SMU Instruments.](#)

[Learn more about the Series 2600B System SourceMeter SMU instruments](#)

Series 2600B System SourceMeter SMU instruments are designed for high speed test in production applications, manufacturing, and high density lab systems. The Series 2600B are available in either single or dual channel models for reduced space in a rack based system.



For an expanded view of Keithley SourceMeter SMU instruments beyond R&D tools for lab/bench applications, read Keithley's e-guide on how to select a SMU instrument.



2400 Series & Model 2450

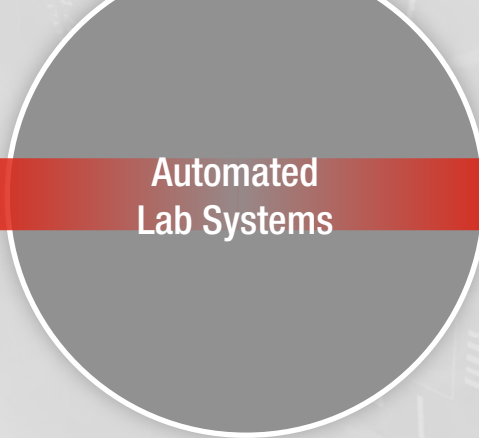

2600 Series



Want assistance, a quote, or to place an order?
[Contact us online.](#)

Join the discussion on our [application forum.](#)

R&D Applications for Keithley SourceMeter® SMU Instruments

There is a never-ending need for better materials and components/devices driven by nanotechnology, energy conversion and generation, advanced low power and high power lighting, and advances in health care and diagnostics. The increase in research for emerging materials and devices begets new users performing current-voltage characterization in research, education, development, and early-phase device environments. Whether

advancing technology in nanoscience, semiconductors, or the boundaries of chemistry/electrochemistry, your success hinges on ultimate measurement reliability and a high degree of confidence that you're getting accurate and valid data. That's why electrical engineers, materials scientists, chemists, electro-chemists, and biologists alike have turned to Keithley SourceMeter SMU instruments for their most challenging applications.

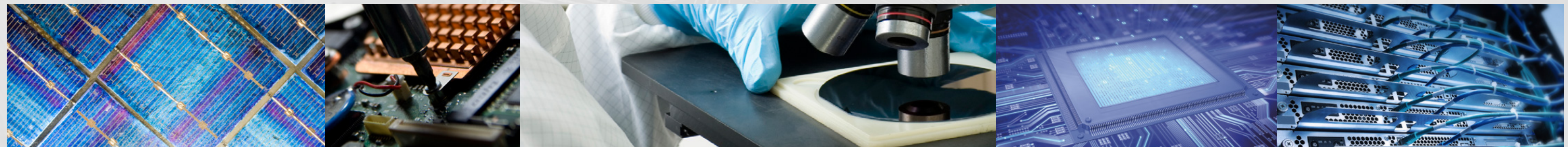

R&D/Bench Application	Facility Type	Who
Nanotechnology	Universities	Test Engineers
Low power semiconductors	Government Research Labs	Physicists
LED/OLED/AMOLED	Industry R&D Labs	Chemists (new)
Photovoltaics	Metrology Labs	Biologists (new)
Printed/Organic Electronics		Electrochemists (new)
Design Validation, Debug		Design Engineers
Electrochemistry		Hardware Engineers
Biotechnology		Graduate Engineers



Guide to Measuring New Materials and Devices

Want assistance, a quote, or to place an order?
[Contact us online.](#)

Join the discussion on our [application forum.](#)

R&D Applications for Keithley SourceMeter® SMU Instruments



Nanotechnology

There is a trend in nanotechnology that is moving beyond CMOS (nano-tech) electronics. Graphene-based electronics (transparent conductors, flexible displays, touch screens), memristor memory, nano-enabled implantables, nano-piezos (energy), sensors, etc. are new areas in nanoscience research.

SMU instruments can be used in nanoscience applications like advanced materials resistance, resistivity, Hall Effect, Quantum Hall, and related IVR measurements.

SMU instruments are practical across the entire nanotechnology

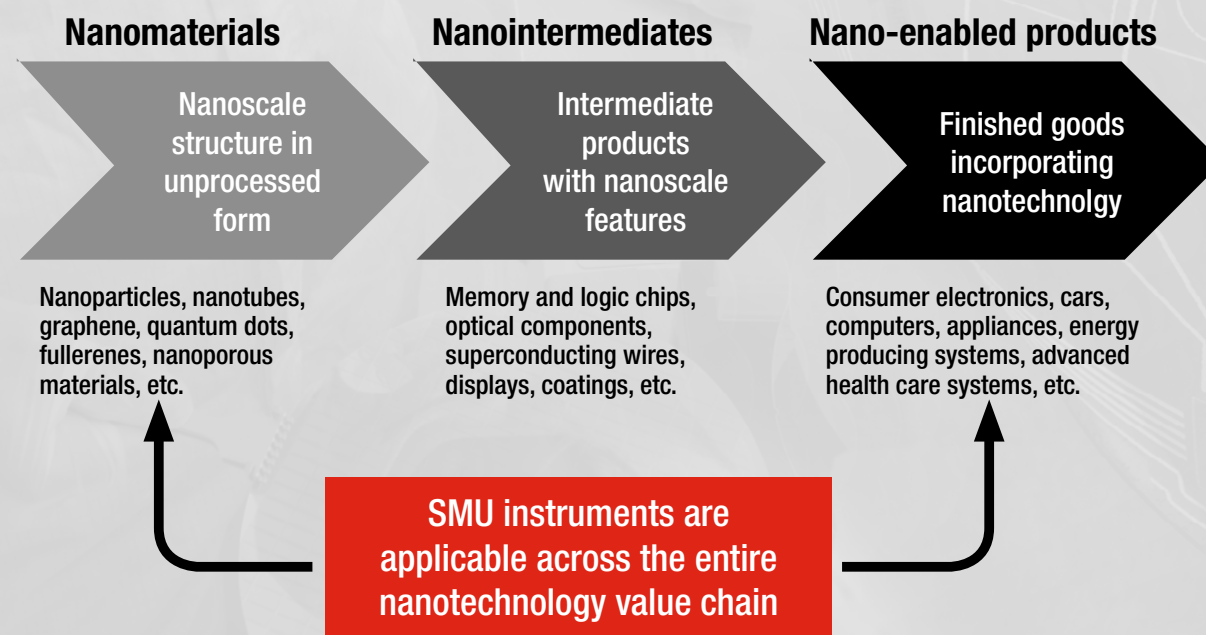

Semiconductor testing

Memory (NAND Flash and DRAM memory), microprocessors and analogue, optoelectronics - sensors - discrete (O-S-D) devices, tablet computers, smartphones, and a wide array of other portable wireless devices will keep semiconductor units growing at a steady pace through 2016. And, SMU instruments are being used in each of these areas to test and characterize diodes, transistors, LEDs, photovoltaic cells, silicon sensors for IV characterization, or resistance/resistivity measurements.

An important advantage of many SMU instruments is their source-level sweeping or stepping capability. Either voltage or current can be stepped across the desired range at specified increments, and the resulting current or voltage can be measured at each step. Unlike a DMM, which can make a measurement at only one point, a SMU instrument can be used to generate a family of I-V curves, because it has a built-in source. This is especially useful when studying semiconductor devices and making materials measurements typically performed across many decades of voltage or current.

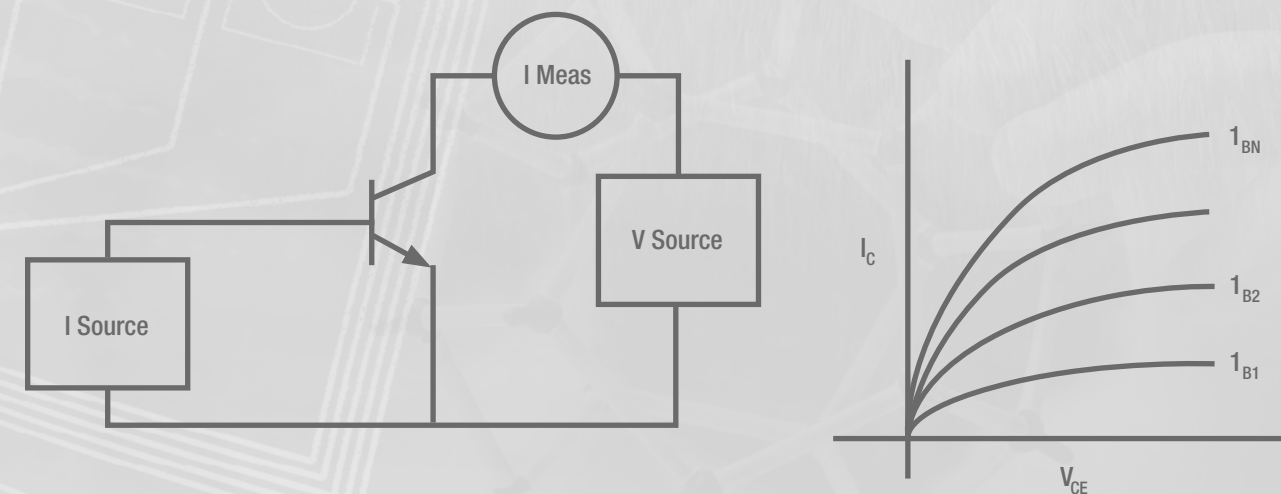

Discover Today's Solutions for Tomorrow's Nano Characterization Challenges

E-Guide to Solving Today's Material and Device Characterization Challenges

R&D Applications for Keithley SourceMeter® SMU Instruments

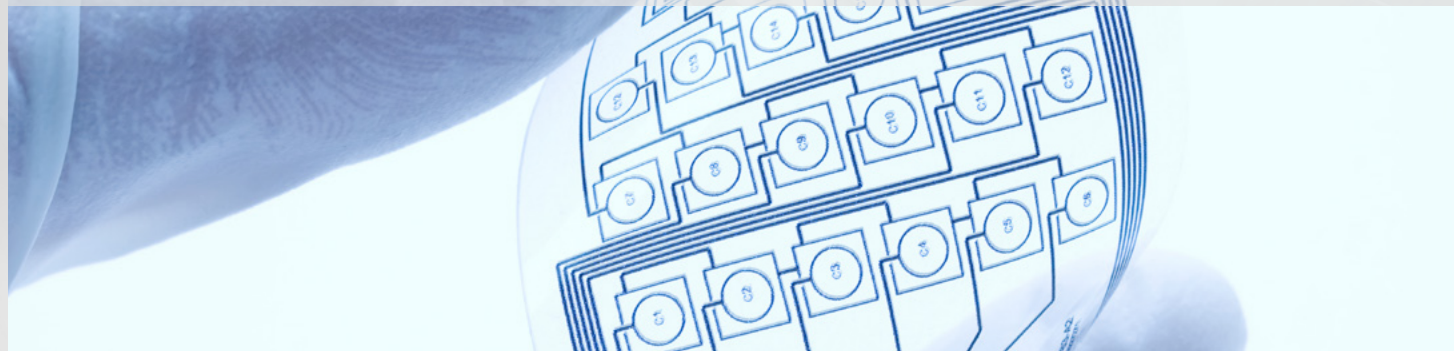

Organic and Printed Electronics

There is an increasing trend of using e-paper displays, OLEDs, organic transistors & memory, thin film / organic photovoltaics and printed electronics. However, there are limitations for organic materials and devices compared to silicon technology. Organic materials based on small molecules do not lend themselves to solution processing of any kind. There is a need for new inks that can be used in the process of printing organic electronics. Organic conductors must have large conductivities for the realization of source/drain contacts and need to have high charge carrier mobilities and high I_{on}/I_{off} ratios to ensure high current values and low leakages. Also, high- κ materials are needed for gate dielectrics and low- κ dielectrics are needed as organic insulating materials. With these come the need for I-V and resistivity testing, for which a SMU instrument is an ideal solution.

Energy Production & Consumption

The growing demand for efficient energy production and management means more focus on green sources of energy like solar panels and wind turbines. The demand for efficiency management in motor drivers, lighting, and power supplies is rising, which in turn drives the use of thin film and light trapping PVs, nano-enabled solar cells, large area solar cells, and advanced LED/OLEDs. There is a test requirement for PV efficiency/lifetime/quality characterization and battery-powered device drain/charge testing for which SMUs could be used.

Discover the Industry Standard for LED Electrical Test Simplify Your Solar Cell Testing with Keithley's Precision Measurement Solutions

Learn more about Solar Cell Testing. View the webinar
Understanding Electrical Characterization of Solar Cells.

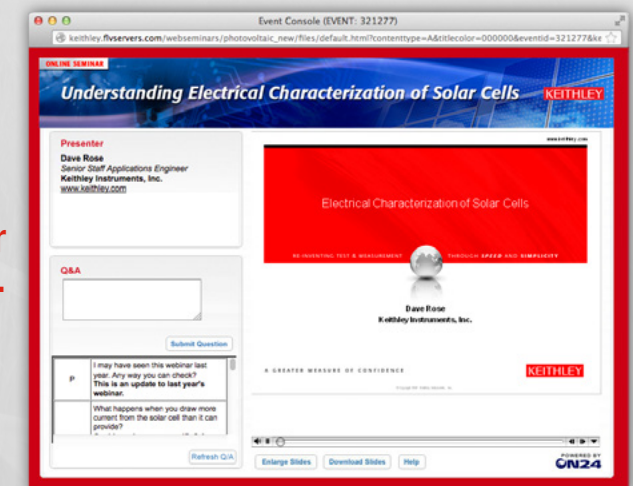

View the webinar **Understanding Electrical Characterization of Printed and Organic Electronics and Materials** to learn more.

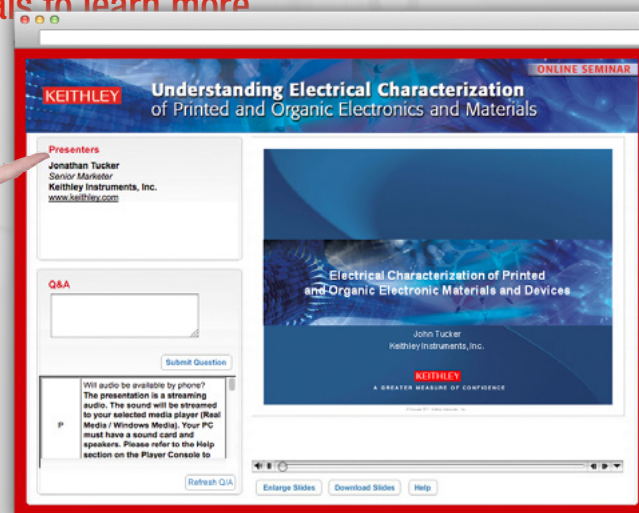

Want assistance, a quote, or to place an order?
Contact us online.

Join the discussion on our [application forum](#).

System SourceMeter® SMU Instruments Selector Guide



Feature	6430 Low I SourceMeter	2430 High Power SourceMeter Instrument	2410 High V SourceMeter Instrument	2420 / 2425 / 2440 High I SourceMeter Instruments	2400 / 2401 Low Power SourceMeter Instruments	2450 Touchscreen SourceMeter Instrument
Current Max / Min	105mA / 10aA	10.5A pulse / 100pA	1.05A / 10pA	5.25A/ 100pA	1.05A / 10pA	.05A/10nA
Voltage Max / Min	200V / 1uV	200V / 1uV	1100V / 1uV	100V / 1uV	200V / 1uV	200V/20mA
Power	2W	1100W	22W	110W	22W	20W
Max readings / sec	256	2,000	2,000	2,000	2,000	3,100
Interface	GPIB, RS-232, Digital I/O, Trigger Link Trigger Bus	GPIB, RS-232, Digital I/O, Trigger Link Trigger Bus	GPIB, RS-232, Digital I/O, Trigger Link Trigger Bus	GPIB, RS-232, Digital I/O, Trigger Link Trigger Bus	GPIB, RS-232, Digital I/O, Trigger Link Trigger Bus	GPIB, USB, LAN/LXI, Digital I/O, TSP-Link
Connectors	Triax	Banana (front / rear)	Banana (front / rear)	Banana (front / rear)	Banana (front / rear)	Banana (front) Triax (rear)

Want assistance, a quote, or to place an order?

[Contact us online.](#)

■ [Join the discussion on our application forum.](#)

Want to learn more about applications for Keithley's growing family of SMU instruments?



Keithley Instruments hosts an online applications forum to encourage idea exchange and discussions among users. [Join the conversation today.](#)

To learn more about how Keithley's high performance SMUs can enhance the productivity of your test and measurement applications, contact your local Keithley representative or [ask us a question online.](#)

Contact us by phone, fax, mail, or email:

KEITHLEY CORPORATE HEADQUARTERS

Keithley Instruments, Inc.
28775 Aurora Road
Cleveland, Ohio 44139
Phone: 440-248-0400
Toll-free: 800-552-1115
Fax: 440-248-6168
info@keithley.com

Consult with a Keithley applications engineer and learn how to get the most from your Keithley products

WORLDWIDE HEADQUARTERS

Within the USA: 1-888-534-8453
Outside the USA: + 1-440-248-0400
Email: applications@keithley.com
Additional contact information at www.keithley.com

EUROPE

Germany: (+49) 89 84 93 07 40

ASIA

China: (+86) 10 8447 5556
Japan: (+81) 120 441 046
Korea: (+82) 2 6917 5000
Taiwan: (+886) 3 572 9077



Specifications are subject to change without notice.

All Keithley trademarks and trade names are the property of Keithley Instruments, Inc.
All other trademarks and trade names are the property of their respective companies.

A Greater Measure of Confidence

KEITHLEY

A Tektronix Company

KEITHLEY INSTRUMENTS, INC. ■ 28775 AURORA RD. ■ CLEVELAND, OH 44139-1891 ■ 440-248-0400 ■ Fax: 440-248-6168 ■ 1-888-KEITHLEY ■ www.keithley.com

BENELUX

+31-40-267-5506
www.keithley.nl

FRANCE

+33-01-69-86-83-60
www.keithley.fr

ITALY

+39-049-762-3950
www.keithley.it

MALAYSIA

60-4-643-9679
www.keithley.com

SINGAPORE

01-800-8255-2835
www.keithley.com.sg

BRAZIL

55-11-4058-0229
www.keithley.com

GERMANY

+49-89-84-93-07-40
www.keithley.de

JAPAN

81-120-441-046
www.keithley.jp

MEXICO

52-55-5424-7907
www.keithley.com

TAIWAN

886-3-572-9077
www.keithley.com.tw

CHINA

86-10-8447-5556
www.keithley.com.cn

INDIA

080-30792600
www.keithley.in

KOREA

82-2-6917-5000
www.keithley.co.kr

RUSSIA

+7-495-664-7564
www.keithley.ru

UNITED KINGDOM

+44-1344-39-2450
www.keithley.co.ukw

For further information on how to purchase or to locate a sales partner please visit www.keithley.com/company/buy