

PA1000
Power Analyzer
User Manual



077-0912-00

Tektronix

**PA1000
Power Analyzer
User Manual**

Firmware version 1.000.000

www.tektronix.com

077-0912-00

Tektronix

Copyright © Tektronix. All rights reserved. Licensed software products are owned by Tektronix or its subsidiaries or suppliers, and are protected by national copyright laws and international treaty provisions.

Tektronix products are covered by U.S. and foreign patents, issued and pending. Information in this publication supersedes that in all previously published material. Specifications and price change privileges reserved.

TEKTRONIX and TEK are registered trademarks of Tektronix, Inc.

Contacting Tektronix

Tektronix, Inc.
14150 SW Karl Braun Drive
P.O. Box 500
Beaverton, OR 97077
USA

For product information, sales, service, and technical support:

- In North America, call 1-800-833-9200.
- Worldwide, visit www.tektronix.com to find contacts in your area.

Warranty

Tektronix warrants that the product will be free from defects in materials and workmanship for a period of five (5) years from the date of original purchase from an authorized Tektronix distributor. If the product proves defective during this warranty period, Tektronix, at its option, either will repair the defective product without charge for parts and labor, or will provide a replacement in exchange for the defective product. Batteries are excluded from this warranty. Parts, modules and replacement products used by Tektronix for warranty work may be new or reconditioned to like new performance. All replaced parts, modules and products become the property of Tektronix.

In order to obtain service under this warranty, Customer must notify Tektronix of the defect before the expiration of the warranty period and make suitable arrangements for the performance of service. Customer shall be responsible for packaging and shipping the defective product to the service center designated by Tektronix, shipping charges prepaid, and with a copy of customer proof of purchase. Tektronix shall pay for the return of the product to Customer if the shipment is to a location within the country in which the Tektronix service center is located. Customer shall be responsible for paying all shipping charges, duties, taxes, and any other charges for products returned to any other locations.

This warranty shall not apply to any defect, failure or damage caused by improper use or improper or inadequate maintenance and care. Tektronix shall not be obligated to furnish service under this warranty a) to repair damage resulting from attempts by personnel other than Tektronix representatives to install, repair or service the product; b) to repair damage resulting from improper use or connection to incompatible equipment; c) to repair any damage or malfunction caused by the use of non-Tektronix supplies; or d) to service a product that has been modified or integrated with other products when the effect of such modification or integration increases the time or difficulty of servicing the product.

THIS WARRANTY IS GIVEN BY TEKTRONIX WITH RESPECT TO THE PRODUCT IN LIEU OF ANY OTHER WARRANTIES, EXPRESS OR IMPLIED. TEKTRONIX AND ITS VENDORS DISCLAIM ANY IMPLIED WARRANTIES OF MERCHANTABILITY OR FITNESS FOR A PARTICULAR PURPOSE. TEKTRONIX' RESPONSIBILITY TO REPAIR OR REPLACE DEFECTIVE PRODUCTS IS THE SOLE AND EXCLUSIVE REMEDY PROVIDED TO THE CUSTOMER FOR BREACH OF THIS WARRANTY. TEKTRONIX AND ITS VENDORS WILL NOT BE LIABLE FOR ANY INDIRECT, SPECIAL, INCIDENTAL, OR CONSEQUENTIAL DAMAGES IRRESPECTIVE OF WHETHER TEKTRONIX OR THE VENDOR HAS ADVANCE NOTICE OF THE POSSIBILITY OF SUCH DAMAGES.

[W19 – 03AUG12]

Table of Contents

Important safety information	v
General safety summary	v
Service safety summary	vii
Terms in this manual	viii
Symbols and terms on the product	viii
Compliance information	x
EMC compliance	x
Safety compliance	xi
Environmental considerations	xiv
Preface	xv
Introduction	1
Basic features	1
Standard accessories	2
Optional accessories	2
Service options	3
Getting started	4
Before you begin - safety	4
Power on	6
Controls and connectors	7
Connecting to the product under test	9
Default measurements	12
Navigating the menu system	13
Data logging	14
Unit configuration	16
The menu system	17
Navigation	17
Modes	18
Inputs	21
Graphs	23
Interfaces	24
System configuration	25
User configuration	26
View	26
Connecting signals	27
Input overview	27
To connect a simple current transformer	28
To connect an external resistive shunt	29
To connect a transducer with a voltage output	30
To connect a voltage transformer / transducer	31

Remote operation	33
Overview	33
Interfacing with USB systems	33
Interfacing with Ethernet systems	33
Interfacing with GPIB systems	34
Status reporting	34
Command listing	37
IEEE 488.2 standard commands and status commands	37
Unit information commands	39
Measurement selection and reading commands	40
Measurement configuration commands	41
Mode setup commands	43
Input setup commands	45
Graph and waveform commands	48
Interface commands	49
System configuration commands	50
User configuration commands	52
View commands	52
Sending and receiving commands	53
Communications examples	54
Software	56
PWRVIEW PC software	56
PA1000 firmware update utility	57
Specifications	58
Measurement channel	58
Power input	58
Mechanical and environmental	59
Communication ports	60
Measured parameters	62
Power polarity	63
Measurement accuracy	64
Index	

List of Figures

Figure 1: PA1000 Power Analyzer	1
Figure 2: Initial power-on display	6
Figure 3: PA1000 front panel	7
Figure 4: PA1000 rear panel	8
Figure 5: Typical PA1000 input connections	9
Figure 6: Breakout box	10
Figure 7: Typical breakout box connections.....	11
Figure 8: Default measurement display.....	12
Figure 9: Display soft keys.....	12
Figure 10: Menu keys.....	13
Figure 11: PA1000 logged data	15
Figure 12: Current transformer connections.....	28
Figure 13: External resistive shunt connections	29
Figure 14: Transducer with voltage output connections	31
Figure 15: Voltage transformer / transducer connections	32
Figure 16: Communication ports	33
Figure 17: PWRVIEW application	56

List of Tables

Table 1: Standard accessories	2
Table 2: Optional accessories	2
Table 3: Service options	3
Table 4: Available measurements per mode	19
Table 5: Phase measurements	62
Table 6: Power polarity	63

Important safety information

This manual contains information and warnings that must be followed by the user for safe operation and to keep the product in a safe condition.

To safely perform service on this product, additional information is provided at the end of this section. (See page vii, *Service safety summary*.)

General safety summary

Use the product only as specified. Review the following safety precautions to avoid injury and prevent damage to this product or any products connected to it. Carefully read all instructions. Retain these instructions for future reference.

Comply with local and national safety codes.

For correct and safe operation of the product, it is essential that you follow generally accepted safety procedures in addition to the safety precautions specified in this manual.

The product is designed to be used by trained personnel only.

Only qualified personnel who are aware of the hazards involved should remove the cover for repair, maintenance, or adjustment.

Before use, always check the product with a known source to be sure it is operating correctly.

This product is not intended for detection of hazardous voltages.

Use personal protective equipment to prevent shock and arc blast injury where hazardous live conductors are exposed.

While using this product, you may need to access other parts of a larger system. Read the safety sections of the other component manuals for warnings and cautions related to operating the system.

When incorporating this equipment into a system, the safety of that system is the responsibility of the assembler of the system.

To avoid fire or personal injury

Use proper power cord. Use only the power cord specified for this product and certified for the country of use.

Do not use the provided power cord for other products.

Ground the product. This product is grounded through the grounding conductor of the power cord. To avoid electric shock, the grounding conductor must be connected to earth ground. Before making connections to the input or output terminals of the product, make sure that the product is properly grounded.

Power disconnect. The power switch disconnects the product from the power source. See instructions for the location. Do not position the equipment so that it is difficult to disconnect the power switch; it must remain accessible to the user at all times to allow for quick disconnection if needed.

Connect and disconnect properly. Do not connect or disconnect probes or test leads while they are connected to a voltage source.

Use only insulated voltage probes, test leads, and adapters supplied with the product, or indicated by Tektronix to be suitable for the product.

Observe all terminal ratings. To avoid fire or shock hazard, observe all ratings and markings on the product. Consult the product manual for further ratings information before making connections to the product. Do not exceed the Measurement Category (CAT) rating and voltage or current rating of the lowest rated individual component of a product, probe, or accessory. Use caution when using 1:1 test leads because the probe tip voltage is directly transmitted to the product.

Do not apply a potential to any terminal, including the common terminal, that exceeds the maximum rating of that terminal.

Do not float the common terminal above the rated voltage for that terminal.

Do not operate without covers. Do not operate this product with covers or panels removed, or with the case open. Hazardous voltage exposure is possible.

Avoid exposed circuitry. Do not touch exposed connections and components when power is present.

Do not operate with suspected failures. If you suspect that there is damage to this product, have it inspected by qualified service personnel.

Disable the product if it is damaged. Do not use the product if it is damaged or operates incorrectly. If in doubt about safety of the product, turn it off and disconnect the power cord. Clearly mark the product to prevent its further operation.

Before use, inspect voltage probes, test leads, and accessories for mechanical damage and replace when damaged. Do not use probes or test leads if they are damaged, if there is exposed metal, or if a wear indicator shows.

Examine the exterior of the product before you use it. Look for cracks or missing pieces.

Use only specified replacement parts.

Use proper fuse. Use only the fuse type and rating specified for this product.

Do not operate in wet/damp conditions. Be aware that condensation may occur if a unit is moved from a cold to a warm environment.

Do not operate in an explosive atmosphere.

Keep product surfaces clean and dry. Remove the input signals before you clean the product.

Provide proper ventilation. Refer to the installation instructions in the manual for details on installing the product so it has proper ventilation.

Slots and openings are provided for ventilation and should never be covered or otherwise obstructed. Do not push objects into any of the openings.

Provide a safe working environment. Always place the product in a location convenient for viewing the display and indicators.

Avoid improper or prolonged use of keyboards, pointers, and button pads. Improper or prolonged keyboard or pointer use may result in serious injury.

Be sure your work area meets applicable ergonomic standards. Consult with an ergonomics professional to avoid stress injuries.

Probes and test leads

Before connecting probes or test leads, connect the power cord from the power connector to a properly grounded power outlet.

Remove all probes, test leads and accessories that are not in use.

Use only correct Measurement Category (CAT), voltage, temperature, altitude, and amperage rated probes, test leads, and adapters for any measurement.

Connect and disconnect properly. De-energize the circuit under test before connecting or disconnecting the current probe.

Connect the probe reference lead to earth ground only.

Do not connect a current probe to any wire that carries voltages above the current probe voltage rating.

Inspect the probe and accessories. Before each use, inspect probe and accessories for damage (cuts, tears, or defects in the probe body, accessories, or cable jacket). Do not use if damaged.

Service safety summary

The *Service safety summary* section contains additional information required to safely perform service on the product. Only qualified personnel should perform service procedures. Read this *Service safety summary* and the *General safety summary* before performing any service procedures.

To avoid electric shock. Do not touch exposed connections.

Do not service alone. Do not perform internal service or adjustments of this product unless another person capable of rendering first aid and resuscitation is present.

Disconnect power. To avoid electric shock, switch off the product power and disconnect the power cord from the mains power before removing any covers or panels, or opening the case for servicing.

Use care when servicing with power on. Dangerous voltages or currents may exist in this product. Disconnect power, remove battery (if applicable), and disconnect test leads before removing protective panels, soldering, or replacing components.

Verify safety after repair. Always recheck ground continuity and mains dielectric strength after performing a repair.

Terms in this manual

These terms may appear in this manual:



WARNING. *Warning statements identify conditions or practices that could result in injury or loss of life.*



CAUTION. *Caution statements identify conditions or practices that could result in damage to this product or other property.*

Symbols and terms on the product

These terms may appear on the product:

- DANGER indicates an injury hazard immediately accessible as you read the marking.
- WARNING indicates an injury hazard not immediately accessible as you read the marking.
- CAUTION indicates a hazard to property including the product.



When this symbol is marked on the product, be sure to consult the manual to find out the nature of the potential hazards and any actions which have to be taken to avoid them. (This symbol may also be used to refer the user to ratings in the manual.)

The following symbol(s) may appear on the product:

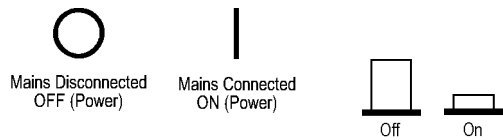

Compliance information

This section lists the EMC (electromagnetic compliance), safety, and environmental standards with which the instrument complies.

EMC compliance

EC Declaration of conformity – EMC

Meets intent of Directive 2004/108/EC for Electromagnetic Compatibility. Compliance was demonstrated to the following specifications as listed in the Official Journal of the European Communities:

EN 61326-1:2006, EN 61326-2-1:2006. EMC requirements for electrical equipment for measurement, control, and laboratory use. ^{1 2 3}

- CISPR 11:2003. Radiated and conducted emissions, Group 1, Class A
- IEC 61000-4-2:2001. Electrostatic discharge immunity
- IEC 61000-4-3:2002. RF electromagnetic field immunity
- IEC 61000-4-4:2004. Electrical fast transient/burst immunity
- IEC 61000-4-5:2001. Power line surge immunity
- IEC 61000-4-6:2003. Conducted RF immunity
- IEC 61000-4-11:2004. Voltage dips and interruptions immunity

EN 61000-3-2:2006. AC power line harmonic emissions

EN 61000-3-3:1995. Voltage changes, fluctuations, and flicker

European contact.

Tektronix UK, Ltd.
Western Peninsula
Western Road
Bracknell, RG12 1RF
United Kingdom

EMC compliance Meets the intent of Directive 2004/108/EC for Electromagnetic Compatibility when it is used with the product(s) stated in the specifications table. Refer to the EMC specification published for the stated products. May not meet the intent of the directive if used with other products.

European contact.

Tektronix UK, Ltd.
Western Peninsula
Western Road
Bracknell, RG12 1RF
United Kingdom

- ¹ This product is intended for use in nonresidential areas only. Use in residential areas may cause electromagnetic interference.
- ² Emissions which exceed the levels required by this standard may occur when this equipment is connected to a test object.
- ³ For compliance with the EMC standards listed here, high quality shielded interface cables should be used.

**Australia / New Zealand
Declaration of Conformity
– EMC**

Complies with the EMC provision of the Radiocommunications Act per the following standard, in accordance with ACMA:

- CISPR 11:2003. Radiated and conducted emissions, Group 1, Class A, in accordance with EN 61326- 1:2006 and EN 61326-2-1:2006.

Australia / New Zealand contact.

Baker & McKenzie
Level 27, AMP Centre
50 Bridge Street
Sydney NSW 2000, Australia

Safety compliance

This section lists the safety standards with which the product complies and other safety compliance information.

**EU declaration of
conformity – low voltage**

Compliance was demonstrated to the following specification as listed in the Official Journal of the European Union:

Low Voltage Directive 2006/95/EC.

- EN 61010-1. Safety Requirements for Electrical Equipment for Measurement, Control, and Laboratory Use – Part 1: General Requirements.
- EN 61010-2-030. Safety Requirements for Electrical Equipment for Measurement, Control, and Laboratory Use – Part 2-030: Particular requirements for testing and measuring circuits.

U.S. nationally recognized testing laboratory listing	<ul style="list-style-type: none">■ UL 61010-1. Safety Requirements for Electrical Equipment for Measurement, Control, and Laboratory Use – Part 1: General Requirements.■ UL 61010-2-030. Safety Requirements for Electrical Equipment for Measurement, Control, and Laboratory Use – Part 2-030: Particular requirements for testing and measuring circuits.
Canadian certification	<ul style="list-style-type: none">■ CAN/CSA-C22.2 No. 61010-1. Safety Requirements for Electrical Equipment for Measurement, Control, and Laboratory Use – Part 1: General Requirements.■ CAN/CSA-C22.2 No. 61010-2-030. Safety Requirements for Electrical Equipment for Measurement, Control, and Laboratory Use – Part 2-030: Particular requirements for testing and measuring circuits.
Additional compliances	<ul style="list-style-type: none">■ IEC 61010-1. Safety Requirements for Electrical Equipment for Measurement, Control, and Laboratory Use – Part 1: General Requirements.■ IEC 61010-2-030. Safety Requirements for Electrical Equipment for Measurement, Control, and Laboratory Use – Part 2-030: Particular requirements for testing and measuring circuits.
Equipment type	Test and measuring equipment.
Safety class	Class 1 – grounded product.
Pollution degree descriptions	<p>A measure of the contaminants that could occur in the environment around and within a product. Typically the internal environment inside a product is considered to be the same as the external. Products should be used only in the environment for which they are rated.</p> <ul style="list-style-type: none">■ Pollution degree 1. No pollution or only dry, nonconductive pollution occurs. Products in this category are generally encapsulated, hermetically sealed, or located in clean rooms.■ Pollution degree 2. Normally only dry, nonconductive pollution occurs. Occasionally a temporary conductivity that is caused by condensation must be expected. This location is a typical office/home environment. Temporary condensation occurs only when the product is out of service.■ Pollution degree 3. Conductive pollution, or dry, nonconductive pollution that becomes conductive due to condensation. These are sheltered locations where neither temperature nor humidity is controlled. The area is protected from direct sunshine, rain, or direct wind.■ Pollution degree 4. Pollution that generates persistent conductivity through conductive dust, rain, or snow. Typical outdoor locations.

Pollution degree rating	Pollution degree 2 (as defined in IEC 61010-1). Rated for indoor, dry location use only.
Measurement and overvoltage category descriptions	<p>Measurement terminals on this product may be rated for measuring mains voltages from one or more of the following categories (see specific ratings marked on the product and in the manual).</p> <ul style="list-style-type: none">■ Category II. Circuits directly connected to the building wiring at utilization points (socket outlets and similar points).■ Category III. In the building wiring and distribution system.■ Category IV. At the source of the electrical supply to the building. <hr/> <p>NOTE. <i>Only mains power supply circuits have an overvoltage category rating. Only measurement circuits have a measurement category rating. Other circuits within the product do not have either rating.</i></p> <hr/>
Mains overvoltage category rating	Overvoltage category II (as defined in IEC 61010-1).

Environmental considerations

This section provides information about the environmental impact of the product.

Product end-of-life handling

Observe the following guidelines when recycling an instrument or component:

Equipment recycling. Production of this equipment required the extraction and use of natural resources. The equipment may contain substances that could be harmful to the environment or human health if improperly handled at the product's end of life. To avoid release of such substances into the environment and to reduce the use of natural resources, we encourage you to recycle this product in an appropriate system that will ensure that most of the materials are reused or recycled appropriately.



This symbol indicates that this product complies with the applicable European Union requirements according to Directives 2002/96/EC and 2006/66/EC on waste electrical and electronic equipment (WEEE) and batteries. For information about recycling options, check the Support/Service section of the Tektronix Web site (www.tektronix.com).

Restriction of hazardous substances

This product is classified as an industrial monitoring and control instrument, and is not required to comply with the substance restrictions of the recast RoHS Directive 2011/65/EU until July 22, 2017.

Preface

This manual covers the setup and use of the PA1000 Power Analyzer. Specifications and remote operation, including programming commands, are included in later chapters.

Introduction

The Tektronix PA1000 is a powerful and versatile precision power analyzer. Designed to provide clear and accurate measurements of electrical power and energy on all single-phase electrical products, the PA1000 is an easy-to-use bench instrument with capability for remote control and data transfer.

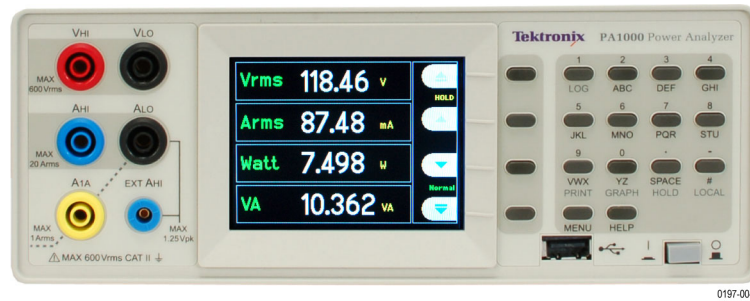

Figure 1: PA1000 Power Analyzer

Basic features

- Measures Watts, Volts, Amps, Volt-Amperes and Power Factor. Always accurate, even on distorted waveforms.
- Range of measurement from milliwatts to megawatts.
- Quick access to results, graphing and menus.
- Built-in energy analyzer (watt-hour integrator) for measuring energy consumption over time.
- Built-in 20 A and 1 A shunts to allow the easy measurement of a wide dynamic range of currents.
- Standby power measurement mode for fast and accurate low power measurements.
- Harmonic analyzer with built in spectrum display.
- Bright color TFT display.
- Comprehensive range of computer interfaces including GPIB, Ethernet and USB as standard.
- Inrush current measurement mode for measuring switch-on and other transient peak currents.
- Ballast mode for measuring the tube power of electronic ballasts.
- Easy-to-use menu system with context-sensitive help.

Standard accessories

Table 1: Standard accessories

Accessory	Tektronix part number
Voltage lead set	PA LEADSET
USB 2.0 cable, A to B, 6 ft. length	174-6053-xx
Documentation CD	063-4519-xx
Power Cord	Country-specific power cord
	<i>One of the following:</i>
	North America (Option A0)
	Universal Euro (Option A1)
	United Kingdom (Option A2)
	Australia (Option A3)
	Switzerland (Option A5)
	Japan (Option A6)
	China (Option A10)
	India (Option A11)
	Brazil (Option A12)
	No power cord or AC adapter (Option A99)

Optional accessories

Table 2: Optional accessories

Accessory	Tektronix part number
Breakout box (North America plug configuration)	BB1000-NA
Breakout box (Euro plug configuration)	BB1000-EU
Breakout box (United Kingdom plug configuration)	BB1000-UK
Specialty current transducer for lamp ballast testing	BALLAST-CT
Current clamp, 1 A - 200 A, for Tektronix Power Analyzers	CL200
Current clamp, 0.1 A - 1200 A, for Tektronix Power Analyzers	CL1200
Replacement lead set for Tektronix Power Analyzers (one channel leadset)	PA-LEADSET

Service options

Table 3: Service options

Option	Description
Opt. C3	Calibration Service 3 Years
Opt. C5	Calibration Service 5 Years
Opt. D1	Calibration Data Report
Opt. D3	Calibration Data Report 3 Years (with Option C3)
Opt. D5	Calibration Data Report 5 Years (with Option C5)

Getting started

Before you begin - safety

Carefully read and adhere to the following warning statements before you connect the Power Analyzer.



WARNING. *To avoid possible electric shock or personal injury:*

- *By connecting the Power Analyzer to active circuits, the terminals and certain parts inside the Power Analyzer are live.*
 - *If possible, open the circuit before establishing a connection to the Power Analyzer.*
 - *Before connecting the circuits, ensure that the maximum measuring voltage and maximum voltage to earth ground (600 V_{RMS}, CAT II) is not exceeded.*
 - *Do not use leads and accessories that do not comply with relevant safety standards, as this could lead to serious injury or death from electric shock.*
 - *Shunts and conductors can generate heat when in use and surfaces may burn the skin.*
-

Qualified personnel

This product may be operated only by qualified personnel. This means only persons who are familiar with the installation, assembly, connection, inspection of connections, and operation of the analyzer and who have been trained in the following areas:

- Switching on/off, enabling, earth-grounding and identification of electrical circuits and services/systems according to the applicable safety standards.
- Maintenance and operation of appropriate safety gear, in accordance with the applicable safety standards.
- First aid.

Ensure that all persons using the device have read and fully understood the Operators Manual and safety instructions.

Installation

- Mains connection must conform to these ranges/values: 100 – 240 V, 50/60 Hz.
- The device may only be used under certain ambient conditions. Ensure that the actual ambient conditions conform to the admissible conditions specified in this manual.
- Ensure this product is installed in such a way that its power cable is accessible at all times and can easily be disconnected.

- Before each use**
- Ensure that the power and connecting cables as well as all accessories and connected devices used in conjunction with this product are in proper working order and clean.
 - Ensure that any third-party accessories used in conjunction with the device conform to the applicable IEC61010-031 / IEC61010-2-032 standards and are suitable for the respective measuring voltage range.

Connection sequence



WARNING. *To avoid possible electric shock or personal injury:*

When the measuring circuit is used to measure MAINS, the voltage to earth may not exceed 600 V_{RMS} in a CAT II environment.

For safety reasons, when connecting a circuit to the Power Analyzer, proceed in the sequence outlined as follows:

1. Connect the Power Analyzer power cord to a properly grounded mains outlet. The Power Analyzer is now connected to the protective earth ground wire.
2. Power on the Power Analyzer.
3. Connect the measuring circuit according to all instructions and as shown in the connection diagrams in this manual.

- During use**
- For connection work, work in teams of at least two persons.
 - If you detect any damage to the housing, controls, power cable, connecting leads, or connected devices, immediately disconnect the unit from the power supply.
 - If you are in doubt as regards the safe operation of the device, immediately shut down the unit and the respective accessories, secure them against inadvertent switching on, and have them serviced by a qualified service person.

Power on

1. Check that the power analyzer is in good condition, with no signs of damage.
2. Follow the *Connection Sequence* described in the *Before you begin - safety* section. (See page 4.)
3. After pressing the power switch at the front to on:
 - The PA1000 will start its power-on sequence. This takes approximately 5–10 seconds.
 - During power on, you will see the PA1000 serial number and firmware version.
4. The instrument is now ready for use.

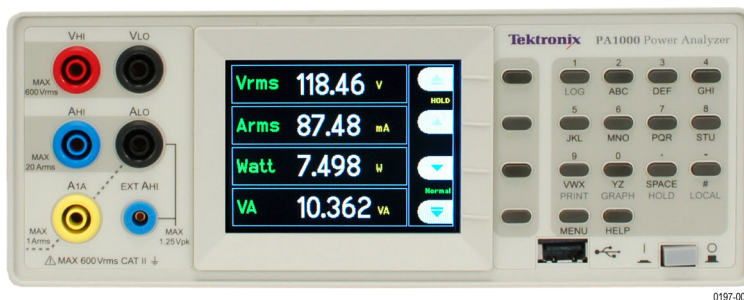

Figure 2: Initial power-on display

Controls and connectors

Use this section to help familiarize yourself with the instrument operation.

Front panel

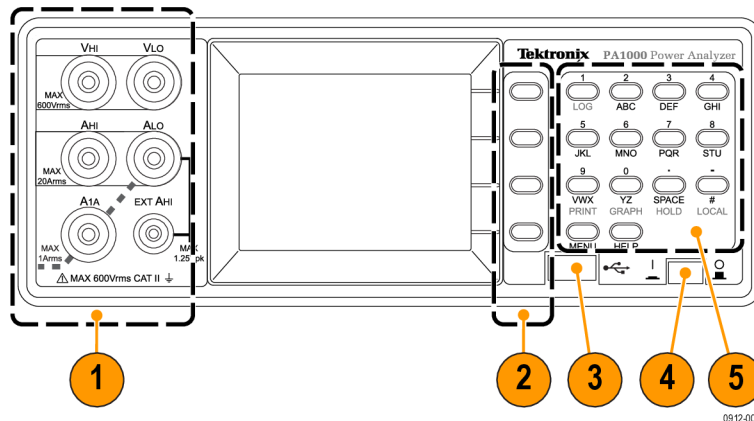

Figure 3: PA1000 front panel

1. Input banana jacks – For safe operation, use only the test lead set supplied with the instrument. Typical connections for the power analyzer are shown later in this section. (See Figure 5 on page 9.)
2. Soft keys – These push buttons control the screen-specific functions that appear on the instrument display. (See Figure 9 on page 12.)
3. USB connection – Use this front-panel USB jack for saving instrument data to your flash drive.
4. Power switch – Push button switch turns on the instrument power.
5. Alphanumeric keypad – Use these keys to input alphanumeric information and to perform functions such as displaying graphs. See *Key shortcuts* below:

Key shortcuts.

- Display main menu: Press MENU (toggle on/off)
- Display system help: Press HELP (toggle on/off)
- Display hold: Press SPACE (toggle on/off)
- Display graph: Press YZ (toggle between graph and results)
- Local control (from remote): Press #
- Toggle Data Logging: Press STU or 1

Rear panel

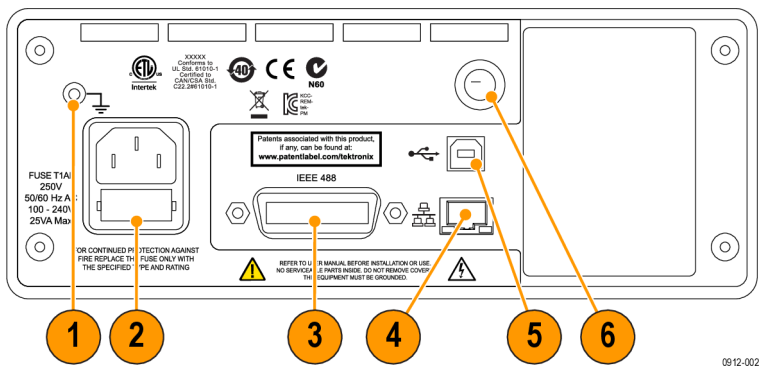

Figure 4: PA1000 rear panel

1. Ground lug – Attach the ground connection from the device under test (DUT) to this rear-panel connector.
2. Power cord connector and line fuse – This connector accepts the country-specific line cords that are available for the instrument. The line fuse is replaceable; see *Specifications* for the correct fuse type.
3. IEEE.488 (GPIB) connector – Use this connection to communicate to the instrument over a GPIB bus.
4. RJ-45 (Ethernet) connector – Use this connection to communicate to the instrument through an Ethernet connection.
5. USB B connector – Use this connection to communicate to the instrument through a USB connection.
6. Front-panel inputs fuse – The input circuitry is protected by this fuse. Refer to *Specifications* for the proper replacement type.

Connecting to the product under test

The PA1000 can measure up to 600 V_{RMS} and 20 A_{RMS} or 1 A_{RMS} directly using the 4 mm terminals on the front panel. For measurements outside the range (low or high power), see the information on using current and voltage transducers. (See page 27, *Connecting signals*.)

To measure power, connect the measuring terminals of the PA1000 in parallel with the supply voltage and in series with the load current as shown below.



WARNING. To avoid injury always use good quality safety cables as supplied and check that they are not damaged before use.



WARNING. If the peak voltage or current exceeds the measurement capability of the instrument, the results screen will be replaced with **Over Range**. At this point, the input levels should be reduced ensure accurate measurements.

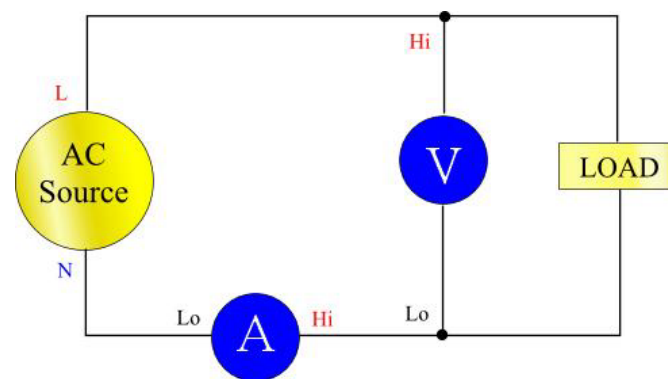

Figure 5: Typical PA1000 input connections

Breakout Box The simplest and safest way to make a connection to the product under test is to use a Tektronix Breakout Box. This provides a line socket for connection of the product and 4 x 4 mm sockets for direct connection to the PA1000 terminals as described above.



Figure 6: Breakout box

There are three versions of the breakout box, differing by the type of line socket: 120 V North America, 230 V Europe and 230 V United Kingdom. See *Optional accessories* for ordering information. (See Table 2 on page 2.)

Connecting the breakout box.

1. Using the test leads provided with the PA1000, make the voltage and current connections between the breakout box and the input jacks on the PA1000. (See Figure 7.)

NOTE. The VLO Source jack on the breakout box is designed for taking measurements in low power, standby applications.

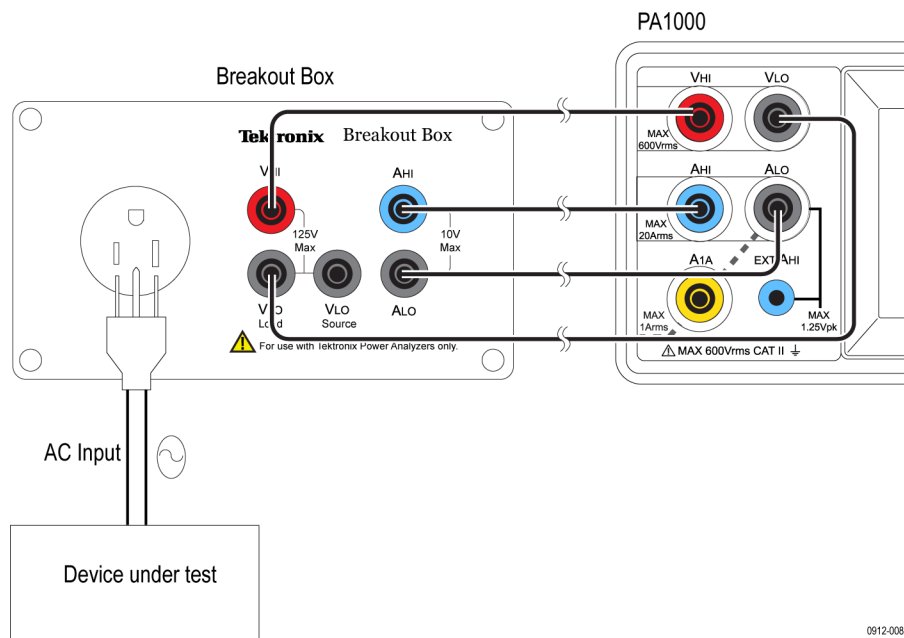

Figure 7: Typical breakout box connections

2. Plug the power cord from the unit under test into the receptacle on the breakout box.
3. Connect a power cord from the line source to the breakout box Line In connector.
4. Power on the unit under test and begin taking measurements.

For other information about the breakout box, refer to the *BB1000 Instructions* that are included with the breakout box.

Default measurements

After you switch on the supply to the load, the PA1000 is ready to take measurements. Note that it is not necessary to switch the PA1000 either off or on when the load is being connected.

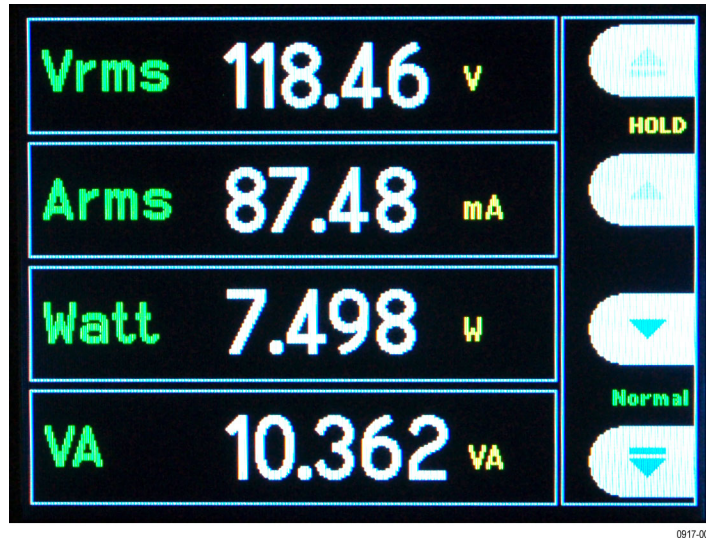

Figure 8: Default measurement display

The default display shows 4 values at one time. Each line clearly shows the measurement type ' V_{RMS} ', the measured value, '118.46' and the measurement units, 'V'. Normal engineering notation is used to describe units, e.g. mV = milli-volts (10^{-3}) and MW = mega-Watts (10^{+6}).

The default measurements are V_{RMS} , A_{RMS} , Watts, Frequency and Power Factor. To scroll through the measurements, use the 4 keys to the right of the display:

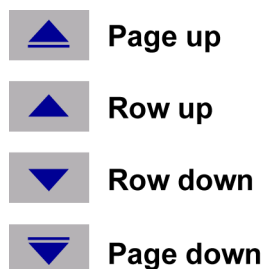

Figure 9: Display soft keys

Navigating the menu system

The menu system provides complete access to all settings of the PA1000. To access the menu system, press the MENU key.

To return to the measurement display at any time, simply press the MENU key again. With the menu system active, the 4 soft keys to the right of the display may be used to navigate and select options.















Menu keys		Up
		Down
		Accept
		Decline
		Up menu
		Down menu
		Delete
		OK

Figure 10: Menu keys

Choosing measurements to display

To choose the measurements on the display:

1. Press MENU to show the menu.
2. Press  to see the list of measurements. Measurements with a  will be displayed in the order shown.
3. Use the  and  keys to select a measurement to display and press .
4. The measurement will be highlighted in red. To move the measurement use the  and  keys.
5. Press **OK** to select the measurement.

To remove a selected measurement, select it and press **X**.

Hint:

To restore the default list, see the User Configuration Menu. (See page 26, *User configuration*.)

Data logging

The PA1000 can log data to a USB flash drive. The unit will log all selected measurements into a comma separated values (CSV) formatted file that is stored on the connected USB flash drive. Results will be logged once per second.

Prior to enabling data logging, insert a USB flash drive into the USB host port on the front of the PA1000.



WARNING. *If the USB flash drive is removed while data logging is enabled, data corruption will occur.*

Logging data

To start data logging, press the 1 key on the PA1000 keypad. Data logging is indicated by the current mode text flashing every second. To stop data logging, press the 1 key on the PA1000 keypad.

Data storage and format

The data will be logged in a directory created by the PA1000 on the USB flash drive. The directory structure created will contain the last five digits of the serial number of the PA1000 used and the date at the start of data logging. The file name will reflect the time at the start of data logging in 24 hr format and will have a .CSV extension.

For example, if a PA1000 with the serial number B010100 begins data logging on 28 June 2013 at 3:10:56 PM, the directory tree will be as shown below:

```
Root Dir\PA1000\10100\20130628\15-10-56.csv
```

The first portion of the file will contain a header identifying the instrument used by serial number and the time data logging began. The second portion of the file will contain column headers for every measurement currently selected. Subsequent lines will contain an indexed set of the measurements currently selected, in the order displayed on the PA1000 screen.

The basic format of the data is shown below. Time and date will be in 24 hr and year, month, day (YYYYMMDD) format respectively.

Tektronix PA1000					
Serial Number: B010100					
Firmware Version 1.000.000					
Start Date (YYYYMMDD): 2013/06/28					
Start Time (24hr): 15: 10:56					
Index	V rms	A rms	Watt	Freq	PF
1	2.09E-1	2.90E-03	1.83E-4	0	3.02E-01
2	2.08E-1	2.90E-03	1.83E-4	0	3.03E-01
3	2.08E-1	2.91E-03	1.82E-4	0	3.01E-01
4	2.08E-1	2.90E-03	1.83E-4	0	3.02E-01

0912-011

Figure 11: PA1000 logged data

USB Flash Drive Requirements:

- The USB flash drive must be formatted with FAT12, FAT16 or FAT32 file systems.
- Sector size must be 512 bytes. Cluster size up to 32 kB.
- Only Bulk Only Mass Storage (BOMS) devices which support the SCSI or AT command sets are supported. For more information on BOMS devices refer to Universal Serial Bus Mass Storage Class – Bulk Only Transport Rev. 1.0, published by the USB Implementers Forum.

Most USB memory devices meet the above requirements.

Printing

Printing directly from the PA1000 is not currently supported, but may be implemented in a future software release.

Unit configuration

To view unit configuration data including hardware revision, firmware revision, serial number, date of last adjustment (calibration), and verification, select:

System Configuration → Unit Configuration

Explanation of adjustment (calibration) type

On the unit configuration screen there are 2 dates related to calibration. They are:

- Last Verified – This is the date the PA1000 was last checked against specification without any adjustments being made.
- Last Adjusted – This is the date calibration information was last changed in the PA1000.

The menu system

Navigation

The menu in the PA1000 is a powerful yet easy-to-use system for control of the analyzer. See the *Quick Start* section of this manual for an overview of how to access and use the menu system. (See page 13, *Navigating the menu system*.)

For help at any time while using the PA1000 press the HELP key at any time.

Menu items To switch the display of the menu system off or on, press the MENU key at any time.

Main menu To select a menu, press the ► key.

Measurements Choose the measurements to display.

To add a new measurement:

1. Select it ▲ and ▼ and press ✓.
2. (Optional) Move the measurement ▲ and ▼ (does not apply to harmonics).
3. Press OK.

To remove a measurement, select it and press X.

Hint: To restore the default list, see the User Configuration Menu.

For information on setup for harmonics and distortion factor, see *System Configuration*.

Modes

Select mode Choose this option to set the PA1000 into one of its operating modes. Each mode is indicated on the front panel measurement display once set. The modes are:

Normal. Ideal for most general measurements.

Ballast. For measuring the output of electronic ballasts. See www.tektronix.com for application notes on this subject. The frequency displayed is the ballast switching frequency.

Inrush. For measuring the peak current during any event. Typically this is used to measure the peak current when a product is first switched on. Press the Reset soft key to set the inrush current to zero.

Standby power. A special mode in the analyzer that allows the user to set a time window over which to accumulate power measurements. When set, power measurements will update after each time window period, other available measurements will update at the normal display update rate of 0.5 seconds. The currently displayed power measurement represents the amount of power accumulated over the last time window only.

Integrator. For energy consumption (W-h) measurements over time. Ideal for rating products whose energy consumption is not constant like washing machines and refrigerators.

Notes on changing mode When you change modes, the measurements that are displayed will change. Adding a measurement to the display will only apply to the currently selected mode. The number of available measurements are different, depending on which mode you are in. The same applies for remote communications since the "FRD?" command, which is used to return results, only returns the results displayed on the screen, in the order in which they are displayed.

The following table lists which measurements are available in which mode, along with which measurements are displayed by default for the selected mode. (See Table 4 on page 19.)

Table 4: Available measurements per mode

Measurement	Mode				
	Normal	Ballast	Inrush	Standby Power	Integrator
V _{RMS}	X*	X*	X	X*	X*
A _{RMS}	X*	X*		X*	X*
Watts	X*	X*		X*	X
VA	X	X		X	X
Var	X	X		X	X
Freq	X*	X*	X	X*	X*
PF	X*	X*		X*	X*
Vpk+	X	X	X*		
Vpk-	X	X	X*		
Apk+	X	X	X*		
Apk-	X	X	X*		
Vdc	X	X			
Vac	X	X			
Vcf	X	X		X	
Acf	X	X			
Vthd	X	X		X	
Athd	X	X			
Z	X				
R	X				
X	X				
Hr					X
Whr					X*
VAhrs					X
VARhr					X
Ahr					X
V-harm	X	X		X	
A-harm	X	X			
V range	X	X	X	X	X
A range	X	X	X	X	X

X = Measurement available

X* = Displayed as default

Also, depending on which mode you change to, other settings may be changed:

- When you change to any mode except Inrush mode, the voltage and the current ranges will be set to auto range.
- When you change to Inrush mode, the voltage and current ranges will be set to the defaults set up under the Inrush mode setup.

Setup mode Choose the mode that you want to set up.



Inrush setup. Choose the default starting current range and the default starting voltage range. Start with the maximum range and then set the mode and make measurements. Choose a lower range with the soft keys for more accuracy once you begin to make measurements. The reset soft key sets the inrush current to zero.

Standby power setup. The time window is the time over which the PA1000 will average the samples. Note that the measurements will only update at the period specified in the time window, with the exception of V_{RMS} , Vcf, Frequency, Vthd, and Vharmonics magnitude and phase which will continue to update every 0.5 seconds.

Integrator setup. The Integrator on the PA1000 operates in two methods, the Manual Start Method and the Clock Start Method. In the Manual Start Method the integrator will start and stop when the user presses the start/stop button and will reset when the user presses the reset button.

In the Clock Start Method the PA1000 will use its real time clock to start the integrator based on the date and time set up by the user. The user will also configure a duration for the Clock Start Method that will stop the integrator at the appropriate time.

The desired Start Method is configured in the Integrator Setup, Start Method menu. Select Manual or Clock using the  key.

If Manual Start Method is selected, nothing more needs to be configured to run the integrator. After the mode is selected, the user will use the start/stop () key to start and stop the integrator and the reset key () to reset the accumulated values.

Note: Use of the reset key () requires the integrator to be stopped. The Clock Start Method is configured in the Integrator Setup menu. Here the user can configure the start date and time and the duration. The starting time and the starting date are entered in the current format of the PA1000, as shown at the time they are entered. The duration is entered in minutes in the range shown on the data entry screen.

Inputs

Set up the measurement inputs – range, scale and low value blanking.

This menu may be used to set up the physical inputs of the PA1000. For normal operation, (20 mA to 20 A_{RMS} and up to 600 V_{RMS}), it is not necessary to change these settings from default.

To select an Inputs menu item, use the ▲ ▼ keys and then press ► for detailed options.

Fixed/Auto ranging

For most measurements, auto-ranging is the best choice. Choosing a fixed range may be useful if the voltage or current is changing continuously or has large peaks that make the analyzer spend excessive time changing range.

Select ▲ ▼ Volts or Amps and press ► to choose the range. Changing the measurement mode will often reset the voltage and current range to auto.

Scaling

Scaling can be used to adjust the PA1000 values to account for the transducer ratio. The scaling factor will affect every measured value related to the input to which it is applied.

When the 600 V and 20 A and 1 A inputs are used directly, then the default setting for Volts and Amps scaling is 1.

To use the PA1000 with external voltage or current transducers, enter a scale factor to make the PA1000 display measurements with proper scaling, accounting for the transducer ratio.

Select ▲ ▼ Volts or Amps and press ► to enter the scale factor. See the Chapter *Using External Voltage and Current Transducers* for further information.

Frequency source

To make accurate rms measurements, the PA1000 must first determine frequency. Normally the PA1000 detects frequency from the voltage signal using proprietary algorithms. If no voltage signal is present, or it is a chopped waveform, then it may be necessary to select Amps as the frequency source. Select Volts or Amps Frequency Source using the ▲ ▼ keys and press ✓ to confirm.

Frequency filter

For optimal frequency measurement performance when measuring voltage signals below 20 kHz, the Low Pass frequency filter can be engaged. If the signal level on the voltage signal is less than 10% of range and the frequency is known to be less than 20 kHz, the Low Pass frequency filter is recommended. Select Auto or Low Pass using the ▲ ▼ keys and press ✓ to confirm.

NOTE. *The frequency filter does not affect the voltage measurement. The filter is for the frequency detection.*

Shunts The PA1000 is fitted with two internal shunts. The 20 A shunt is suitable for measurements from 20 mA to 20 A_{RMS}. The 1 A shunt is suitable for measurements from 400 uA to 1 A. These ranges may be extended by the use of suitable current transducers from uA to MA.

Some current transducers (including simple resistive shunts) produce a voltage that is proportional to current. External Shunt Inputs are provided on the PA1000 for use with current transducers that provide a voltage output. Because the 0 V is common to both the internal and external shunts, only one type may be connected at any time.

Select Internal (20 A), Internal (1 A) or External Shunt using the ▲ ▼ keys and press ✓ to confirm. See *Using voltage and current transducers* for further information.

Blanking Normally enabled. Select Disable to measure voltage or current that are small. If blanking operates on either voltage or current then all related measurements would be blanked including W, VA and PF. Select Disable or Enable using the ▲ ▼ keys and press ✓ to confirm.

Averaging Normally disabled. Select Enable to allow the PA1000 to average results, for more stable measurements of fluctuating signals. Averaging depth is set at four when enabled. All results, including harmonic magnitude and phase, are averaged except for ranges (when selected for display) and cumulative measurements (Whrs, VAhrs, VARhrs, Ahrs, and Hrs). Select Disable or Enable using the ▲ ▼ keys and press ✓ to confirm.

Graphs

To set up the graphical displays of the PA1000, select the graph type using the ▲ ▼ keys and press ► for options.

Hint: Use the YZ key to toggle between graphic and numeric displays.

Waveform graph

This will display the voltage, current and (optionally) the Watts waveform. The scale of the graph is set automatically according to the selected range and scaling. Display of the Watts graph may be disabled.

Use the ▲ ▼ keys to select Show and then press ✓ to display the Waveform Graph. Select 'Watts' to add the instantaneous watts waveform to the display.

NOTE. Waveforms will only be displayed when there is a valid frequency. DC waveforms will not be displayed.

Harmonic bar chart

Select Voltage or Current harmonic bar chart using the ▲ ▼ keys and press ► for details.

The scale is the maximum amplitude that will be displayed. Set the scale to be similar to the rms value to see an overview of the spectrum. To view smaller harmonics in more detail a smaller scale may be set.

If the harmonic exceeds the set scale it will be shown with a white cap on the top of the bar.

The scale only applies when the harmonic format is absolute measurements. If percentage measurements are used, then the scale is automatically set to 100%. The fundamental harmonic (H1) will be displayed as 100%.

The right ► and left ◀ arrow keys may be used to select the harmonic whose amplitude and phase are shown at the top of the screen. The selected harmonic is shown in yellow. Select ▲ ▼ Show and press ✓ to display the harmonic bar chart (voltage or current).

Integration graph

Select Integration graph using the ▲ ▼ keys, press ► to configure.

The Integration Graph menu allows the user to select what value to display on the graph, the vertical scale of the graph (in units of the value selected), and the horizontal scale (duration) of the graph.

The horizontal scale of the graph is only for display purposes. The integration will continue until stopped by the user using the start/stop (●/●) button. The reset key (↵) can be used to reset the accumulated values.

NOTE. Use of the reset key (↵) requires the integrator to be stopped.

When the graph is configured, select Show to view the graph. Note: The PA1000 must be in Integrator mode for the graph to start.

Interfaces

This menu may be used to set up the interfaces of the PA1000.

To select set up an interface, use the ▲ ▼ keys, and then press ► for detailed options.

GPIB address

Enter the GPIB address and press OK.

Default address is 6. The address is unchanged after a “*RST” or “:DVC” command.

Ethernet configure

The PA1000 offers Ethernet communications through an Ethernet port using TCP/IP.

The Ethernet port will make a TCP/IP connection on port 5025. Port 5025 is designated by the Internet Assigned Numbers Authority (IANA) to be a SCPI port.

Use the IP Selection Method menu, and the ▲ ▼ keys to opt for a dynamically assigned IP address, by selecting “Set IP using DHCP”, or a fixed/static IP address by selecting “Fix IP Address” with the ✓ button.

To view the current IP settings, choose “Current IP Settings” in the Ethernet Setup menu. This allows you to view the current IP address, subnet mask, and default gateway.

To configure the static IP address, choose “Static IP Settings” in the Ethernet Setup menu. This allows you to enter the IP address, the subnet mask and the default gateway. After entering the relevant data, press the OK button in each menu to apply.

The Ethernet mode (Static/DHCP), IP address, default gateway and subnet mask are unchanged after a “*RST” or “:DVC” command.

System configuration

Set up harmonics, distortion, the clock and auto zero.

To select a menu item, use the ▲ ▼ keys and then press ▶ for detailed options.

Harmonics setup

For both voltage and current harmonics, a number of different parameters can be set. These settings are independent of the mode that is currently selected:

- Sequence: All or odd harmonics only
- Range: The maximum harmonic (up to 50)
- Format: Display harmonics as absolute values or as a percentage of the fundamental (1st) harmonic.

Distortion setup

For both voltage and current harmonics, a number of different parameters can be set. These settings are independent of the mode that is currently selected. Four following settings can be made for distortion:

- Formula: Series (Total Harmonic Distortion) or difference (Distortion Factor). (The default = series formula)
- Sequence: Include all harmonics or only odd harmonics in the series formula. (default = all harmonics)
- Range: The maximum harmonic to be included in the series formula. (default = 7)
- DC (H0): Include or exclude DC in the series formula. (default = exclude)
- Reference: rms or 1st harmonic. (default = rms)

For details of the actual equations used, (See page 62, *Measured parameters*.)

Auto Zero

Normally the PA1000 will cancel any small dc offsets in the measurement automatically. This feature is referred to as Auto Zero.

Auto Zero should always be enabled except in certain applications such as Inrush current measurement.

Select ▲ ▼ Disable and Enable and press ✓ to confirm.

Clock setup

These options may be used to check or set the PA1000 internal clock. To select a menu item, use the ▲ ▼ keys and then press ▶ for detailed options.

Set Time - Enter the time using the format shown and press OK to confirm.

Set Date - Enter the date using the format shown and press OK to confirm.

Time Format - Select ▲ ▼ 12 Hour or 24 Hour and press ✓ to confirm.

Date Format - Select ▲ ▼ the required date format and press ✓ to confirm.

Unit configuration

The Unit Configuration menu displays the hardware revision, firmware revision, serial number, date of last adjustment and verification.

User configuration

The PA1000 has the ability to store and recall up to 5 different setups.

To select a menu item, use the ▲ ▼ keys and then press ► for detailed options.

The first option is to 'Load Default'. Choosing this option sets every menu option of the PA1000 to its factory default.

The other menu items (Default 'CONFIGURATION n') may be used to store and recall all settings of the PA1000.

For each User Configuration you can go into a sub menu and you may:

- Apply – apply the saved configuration.
- Rename – give the configuration a meaningful name. A name can be up to 16 characters.
- Save Current – save a configuration. This is always the complete setting of the PA1000 at the time you choose this option.

NOTE. Loading a configuration that has never been saved will result in an error message. The current configuration of the unit will not be changed.

View

To select a menu item, use the ▲ ▼ keys and then press ► for detailed options.

Zoom

Use the Zoom function to select the number of measurement results that are displayed on the instrument screen. The selections are either 4 or 14. Select ▲ ▼ — either 4 results or 14 results display and press ✓ to confirm.

Connecting signals

Input overview



WARNING. To avoid possible electric shock or personal injury:

- Do not touch connections, internal circuits or measuring devices that are not connected to earth ground.
- Always adhere to the instructions regarding the sequence of connection. (See page 5, Connection sequence.)

Signals are connected to the PA1000 on the front of the PA1000.

- Voltage** Voltages of up to 600 V_{RMS} may be connected directly to the red and black 4 mm VHI and VLO safety sockets at the front of the PA1000.
- Current** Currents of up to 20 A_{RMS} may be connected directly to the blue and black 4 mm AHI and ALO safety sockets at the front of the PA1000. Alternatively, if you are making measurements of less than 1 A_{RMS}, 2 A_{peak}, connect the current to be measured between the yellow A1A and black ALO connections.

External current input The external current input, EXT AHI, accepts voltages up to 1.25 V_{peak} that are proportional to the current being measured. This input allows a very wide range of external current transducers to be connected, from low-milliamp current shunts to mega-Amp current transformers. For each type of transducer, the PA1000 may be scaled to read the correct current. (See page 21, *Inputs*.)

The choice of current transducer will depend on:

- The current being measured, including peaks and transients
- The accuracy required
- The bandwidth required: Unless the waveforms are purely sinusoidal, a bandwidth in excess of the fundamental frequency will be required.
- Whether there is DC current present
- Convenience of connection – that is, using a clamp-on current transformer, with jaws that open, for quick connection in a fixed wiring loom.
- The effect of the transducer on the circuit

To connect a simple current transformer

To use a conventional current transformer (CT) like the Tektronix CL series (or any other transducer with a current output), connect the normal AHI and ALO inputs of the PA1000 to the outputs of the current transformer. Follow the manufacturers instructions for the safe use and installation of the transducer.

Normally the positive or HI output of the transducer will be marked with the point of an arrow or a + symbol. Connect this terminal to the appropriate AHI input of the PA1000.

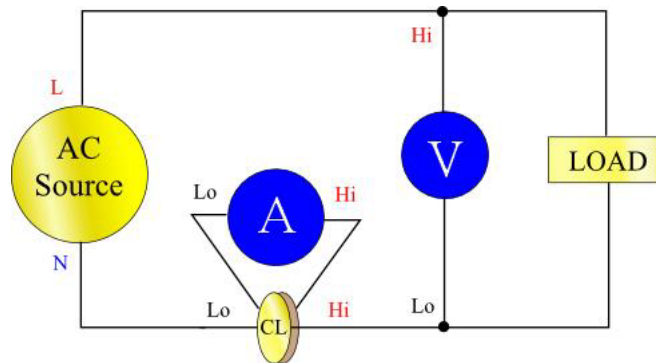

Figure 12: Current transformer connections

Current scaling

A current transformer produces an output current that is proportional to the load current being measured.

To measure the correct current on the PA1000, use the scaling function of the analyzer to scale, or multiply, the CT output current.

For example, the CL200 is a 1000:1 CT. When measuring 100 A, its output is 100 mA. To scale this on the PA1000, a scale factor of 1000 must be entered:

Press MENU

Select ▲ ▼ 'Inputs' and press ►

Select ▲ ▼ 'Scaling' and press ►

Select ▲ ▼ 'Amps' and press ►

Type the new scale factor (1000)

Press **O.K.**

Press MENU to return to the measurement display.

The PA1000 is now ready to make measurements using a CT.

To connect an external resistive shunt

Using a resistive shunt is a straightforward method of extending the current measuring range of the PA1000. The shunt resistor is connected in series with the load and the voltage across the shunt is directly proportional to current.

That voltage may be connected directly to the External Current Inputs of the PA1000.

For example, a 1 milliohm shunt is used to measure 200 A_{RMS}.

1. Check that the voltage that will be generated is suitable for the PA1000

$$V = I \times R \text{ (Ohm's law)}$$

$$V_{\text{shunt}} = I \times R_{\text{shunt}}$$

$$V_{\text{shunt}} = 200 \times 0.001 \text{ Ohms}$$

$$V_{\text{shunt}} = 0.2 \text{ V}$$

This is well within the 1 V rating of the External Current Inputs on the PA1000.

2. Connect the shunt in series with the load and to the EXT AHI and ALO inputs as shown.

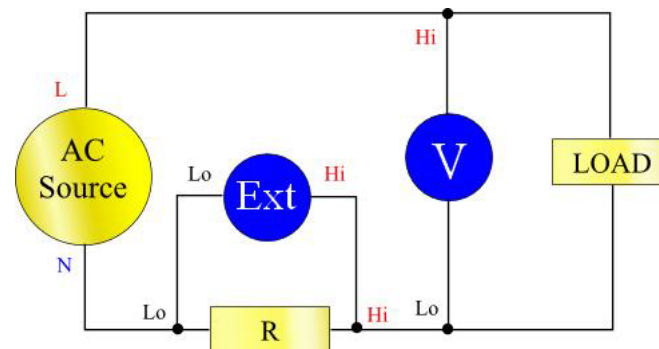

Figure 13: External resistive shunt connections



WARNING. AHI, AIA, EXT AHI and ALO are connected inside the PA1000 via a low impedance shunt. To avoid errors and a risk of electric shock, remove all connections to AHI and AIA.

3. Set up the PA1000 to measure current from the EXT AHI and ALO terminals.

Press MENU

Select ▲ ▼ Inputs and press ►

Select ▲ ▼ Shunts and press ►

Select ▲ ▼ External and press ✓

Press MENU to return to the measurement display.

4. Scale the measurement on the display.

The default scale is 1 V = 1 A.

In this example where $R = 0.001$ Ohms. The scaling factor is specified in Amps per Volt, so in this case, the scaling factor is 1000.

To enter a scale factor for current:

Press MENU

Select ▲ ▼ Inputs and press ►

Select ▲ ▼ Scaling and press ►

Select ▲ ▼ Amps and press ►

Type the new scale factor (1000)

Press 

Press MENU to return to the measurement display.

The PA1000 is now ready to make measurements using an external shunt.

To connect a transducer with a voltage output

These transducers contain active circuits that help to improve performance at high bandwidth. They may be of the hall effect or Rogowski coil type.

The procedure is similar to that of installing an external shunt as described above.

1. Follow the manufacturer's instructions for the safe use and installation of the transducer.
2. Connect the voltage output to the EXT-HI and A-LO terminals of the PA1000 as above.
3. Select Inputs – Shunts – External as above.

Press MENU

Select ▲ ▼ Inputs and press ►

Select ▲ ▼ Shunts and press ►

Select ▲ ▼ External and press 

Press MENU to return to the measurement display.

4. Select and input a scale factor. These types of transducers are often rated in terms of mV / amp. For example, a transducer with an output of 100 mV / amp is the equivalent of a 100 milliohm external shunt resistor. To convert the rated

scaling from Volts per Amp to the desired Amps per Volt, invert the value. Using the above example, $100 \text{ mV} / \text{Amps}$ is equivalent to $10 \text{ Amps} / \text{Volt}$.

Press MENU

Select ▲ ▼ Inputs and press ►

Select ▲ ▼ Scaling and press ►

Select ▲ ▼ Amps and press ►

Type the new scale factor (such as 0.1)

Press **OK**

5. Press MENU to return to the measurement display.

The PA1000 is now ready to make measurements using a current transducer with a voltage output.

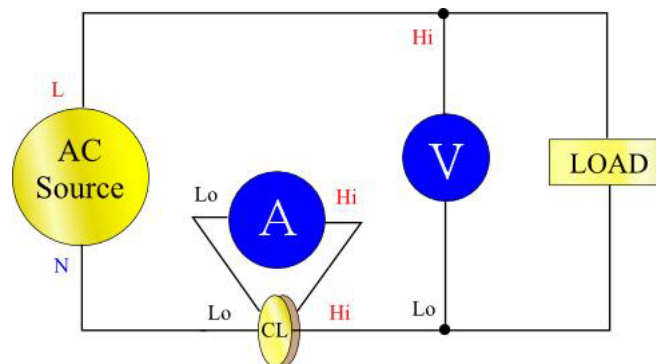

Figure 14: Transducer with voltage output connections

To connect a voltage transformer / transducer

The PA1000 may be used with a voltage transformer (VT) or other transducer to extend its measuring range. Follow the manufacturer's instructions for the safe use and installation of the transducer.

The output of the transducer is connected to the normal VHI and VLO terminals. Normally, the positive or HI output of the transducer will be marked with the point of an arrow or a + symbol. Connect this terminal to the VHI input of the PA1000.

Voltage scaling

A voltage transformer (VT) produces a voltage output, which is proportional to the voltage being measured.

To measure the correct voltage on the PA1000, use the scale function of the analyzer to scale, or multiply, the VT output current.

For example, when measuring with a 1000:1 VT a scale factor of 1000 must be used.

Press MENU

Select ▲ ▼ Inputs and press ►

Select ▲ ▼ Scaling and press ►

Select ▲ ▼ Volts and press ►

Use the CLR key to clear the entry.

Type the new scale factor (1000)

Press O.K.

Press MENU to return to the measurement display.

The PA1000 is now ready to make measurements using a VT.

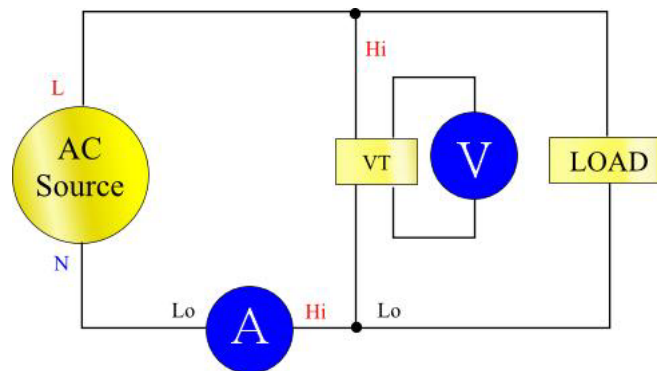

Figure 15: Voltage transformer / transducer connections

Remote operation

Overview

You can use remote commands for the PA1000 to perform high speed, complex or repetitive measurements. The PA1000 can communicate via GPIB, Ethernet or USB.

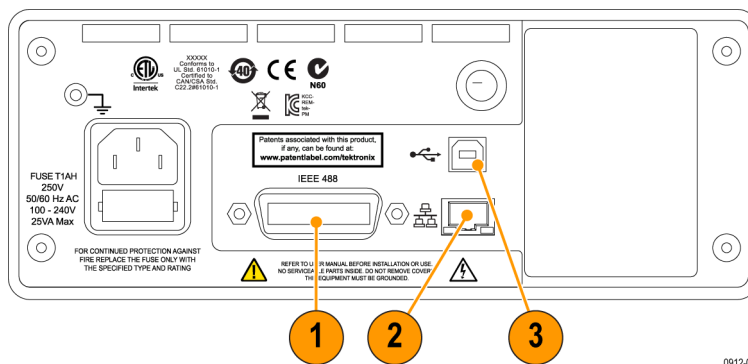

Figure 16: Communication ports

1. GPIB
2. Ethernet
3. USB

Interfacing with USB systems

The PA1000 supports USB control using the Test and Measurement class.

A detailed pin description of the port, along with speed and connection information is given in the specifications. (See page 61, *USB peripheral*.)

Interfacing with Ethernet systems

The PA1000 supports Ethernet control using a 10Base-T network.

See *Ethernet port* for more information on the Ethernet connection. (See page 61, *Ethernet port*.)

See *Ethernet configure* for information on how to set up the Ethernet addressing information. (See page 24, *Ethernet configure*.)

Interfacing with GPIB systems

The PA1000 supports control via a GPIB port.

See *IEEE 488/GPIB* for a detailed pin description of the GPIB connector. (See page 60, *IEEE 488 / GPIB* .)

Status reporting

Status byte

The PA1000 uses a status byte similar to IEEE488.2. The PA1000 Status Byte Register (STB) contains the ESB and DAS bits. These two bits indicate a non-zero state in the Standard Event Status Register (ESR) or the Display Data Status Register (DSR) respectively.

The ESR and DSR each have enable registers, ESE and DSE respectively, that is set by the user. These enable registers act as a mask to reflect chosen elements of the appropriate status registers to the Status Byte Register. Setting the appropriate bit of the enable register to 1 configures transparency.

If a status register is read, that register is reset to zero.

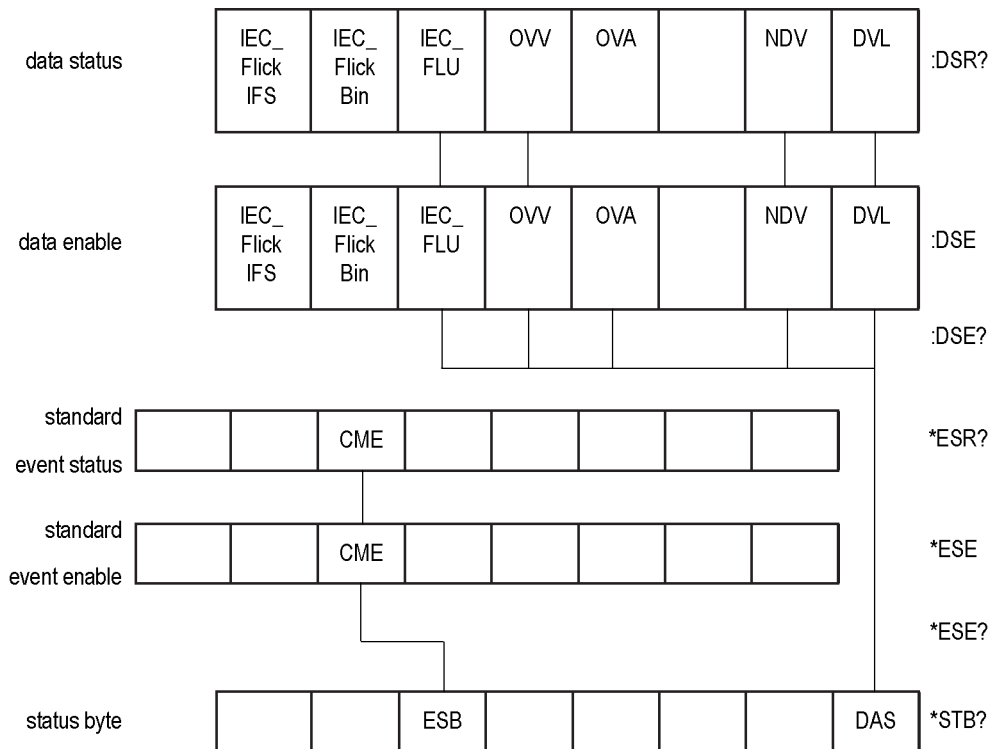

Status Byte Register (STB) Read by “*STB?”.



Bit 5 - ESB Summary bit to show standard event status.

Bit 0 - DAS Summary bit to show display data available.

Display Data Status Register (DSR)

Read by “:DSR?” or in summary by *STB? DAS bit. On power-up DSR is initialized to zero. When read using the “:DSR?” command the register bits are cleared as listed below.

IEC_ Flick IFS	IEC_ Flick Bin	IEC_ FLU	OVV	OVA		NDV	DVL
----------------------	----------------------	-------------	-----	-----	--	-----	-----

Bit 7 – IEC_FlickIFS. Set to indicate availability of new IFS data in IEC Flicker mode. Cleared when read.

Bit 6 – IEC_FlickBin. Set to indicate availability of new IEC Flicker Bin data in IEC Flicker mode. Cleared when read.

Bit 5 – IEC_FLU. Set to indicate availability of new IEC Fluctuating Harmonics data in IEC Fluctuating Harmonics mode. Cleared when read.

Bit 4 - OVV. Set to indicate there is a voltage range overload. Automatically cleared when range overload clears.

Bit 3 - OVA. Set to indicate there is a current range overload. Automatically cleared when range overload clears.

Bit 1 - NDV. Set to indicate that new data has become available since the last :DSR? command. Cleared when read.

Bit 0 - DVL. Set to indicate the availability of data. Cleared when read.

Display Data Status Enable Register (DSE)

Read by “:DSE?” and set by “:DSE <value>”.

IEC_ Flick IFS	IEC_ Flick Bin	IEC_ FLU	OVV	OVA		NDV	DVL
----------------------	----------------------	-------------	-----	-----	--	-----	-----

Bit 7 – IEC_FlickIFS. Enable IEC_FlickIFS bit in DSR. (Default to enabled on power-up.)

Bit 6 – IEC_FlickBin. Enable IEC_FlickBin bit in DSR. (Default to enabled on power-up.)

Bit 5 - IEC_FLU. Enable IEC_FLU bit in DSR. (Default to enabled on power-up.)

Bit 4 - OVV. Enable OVV bit in DSR.

Bit 3 - OVA. Enable OVA bit in DSR.

Bit 1 - NDV. Enable NDV bit in DSR. (Default to enabled on power-up.)

Bit 0 - DVL. Enable DVL bit in DSR. (Default to enabled on power-up.)

Standard Event Status Register (ESR)

Read by “*ESR?” or in summary by the ESB bit in STB.

		CME					
--	--	-----	--	--	--	--	--

Bit 5 - CME. Command error; command not recognized.

Standard Event Status Enable Register (ESE)

Read by “*ESE?” and set by “*ESE <value>”. Cleared when read.

An invalid command is reported in the DSR register by setting a flag in the Standard Event status Register. The flag shall be cleared when the register is read “*ESR?”. An invalid query can have an unpredictable result, and may require that you power-cycle the unit and/or the PC.

		CME					
--	--	-----	--	--	--	--	--

Bit 5 - CME. Enable CME bit in ESR. (Default to enabled on power-up.)

Command listing

The following conventions are used in the next section to describe the command syntax:

- Square brackets indicate optional parameters or keywords []
- Triangle brackets indicate values to be specified < >
- Vertical bar indicates the choice of parameters |

Commands and responses are sent as ASCII strings terminated with a line feed. The PA1000 is not case sensitive and white space characters are ignored except where required between command and parameter.

Multiple commands cannot be sent in a single string where a ‘;’ character is used at the end of each command.

For all commands where a parameter is supplied, one or more spaces are required between the end of the command and the first parameter. For example, “:CAL:DATE 1” will work. “:CAL:DATE?1” will cause a time out error.

All non-common commands (those with ‘*’ as the first character) must have a leading colon ‘:’. Although the IEEE 488.2 standard does not require this, the PA1000 does. For example, :avg? works, but Avg? does not. :avg:aut works but avg:aut does not.

The list of commands is split into relevant sections. In general each section corresponds to a menu option from the main menu on the PA1000.

IEEE 488.2 standard commands and status commands

*IDN? Unit identity

Syntax	*IDN?
Return format	Tektronix, PA1000, serial number, firmware version
Description	The serial number is the serial number of the product. The firmware version is the version of the firmware suite.

*CLS Clear event status

Syntax	*CLS
Description	Clears the standard event status register to 0

***ESE Set standard event status enable register**

Syntax	*ESE <flags> Where flags = value for enable register as a decimal 0 – 255
Default	32
Description	Sets the bits that are enabled in the standard event status register. The status enable register uses the same bit definitions as the standard event status register

***ESE? Read standard event status enable register**

Syntax	*ESE?
Return format	0 - 255
Description	Returns the value in the standard event status enable register.

***ESR? Read event status register**

Syntax	*ESR?
Return format	0 - 255
Description	Returns the value in the standard event status register, AND'ed with the value in the standard event status enable register. The event status register is cleared once it has been read

***RST Reset device**

Syntax	*RST
Description	Resets the status reporting and returns the settings to default values (performs the same action as Load Default Configuration menu option on the front panel)

Tip. Allow 5 – 10 seconds after *RST has been sent prior to executing further commands to allow all defaults to processed and set.

***STB? Read status byte**

Syntax	*STB?
Return format	0 - 255
Description	Returns the value in the status byte, masked by the service request enable register. Once read, the status byte is cleared to 0

:DSE Set Data Status Enable Register

Syntax	:DSE <flags>
Default	255
Description	Sets the bits that are enabled in the display status register

:DSE? Read Data Status Enable Register

Syntax	:DSE?
Return format	0 – 255
Description	Returns the value in the data status enable register

:DSR? Read Data Status Register

Syntax	:DSR?
Return format	0 – 255
Description	Returns the value in the data status register, AND'ed with the value in the data status enable register. The data status register is cleared once it has been read

:DVC Device clear

Syntax	:DVC
Description	Resets the unit configuration to default values.

Unit information commands

The unit information commands are commands that are used to return information on the unit beyond the information returned by the *IDN? command.

:CAL:DATE? Calibration date

Syntax	:CAL:DATE? <date type> <date type> is 1 through 2
Return format	Appropriate calibration date in the format dd-mm-yyyy
Description	Returns the calibration date from the PA1000. <date type> can be either: 1 = Date verified 2 = Date adjusted

Measurement selection and reading commands

These commands are related to selecting the measurements required and returning those results.

:SEL **Select results**

Syntax :SEL:CLR
 :SEL:<measurement>
 Where <measurement> is:
 VLT - Volts rms
 AMP - Amps rms
 WAT - Watts
 VAS - VA
 VAR - VAr
 FRQ - Frequency
 PWF - Power factor
 VPK+ - Volts peak (positive)
 VPK- - Volts peak (negative)
 APK+ - Amps peak (positive)
 APK- - Amps peak (negative)
 VDC - Volts DC
 ADC - Volts DC
 VCF - Voltage crest factor
 ACF - Amps crest factor
 VDF - Volts Distortion Factor
 ADF - Amps Distortion Factor
 IMP - Impedance
 RES - Resistance
 REA - Reactance
 HR - Integrator time *1
 WHR - Watt Hours *1
 VAH - VA Hours *1
 VRH - VAr Hours *1
 AHR - Amp Hours *1
 VRNG - Voltage range
 ARNG - Amps range
 VHM - Volts harmonics
 AHM - Amps harmonics
 *1 – These results are only available
 for displaying / returning when in
 integrator mode.

Description :SEL determines which results are displayed on the screen also the results returned by the FRD? command. To see the currently selected command the "FRF?" command should be used.
SEL:CLR clears all the results.

:FRF? Read selected results

Syntax	:FRF?
Description	<p>FRF? command is used to return a list of the displayed results. The actual result is not returned. The return format is: <number of measurements selected>, <number of results returned>, <measurement 1>,<measurement 2>,... and so forth.</p> <p><number of measurements selected> is the number of measurements selected using either the front panel or the SEL command <number of results returned> equates to the number of rows on the display used. When harmonics are selected, the number of results returned will exceed the number of measurements selected <measurement 1> and so forth, is the name of the measurement selected. The returned data will be the same as the label used on the results display. For harmonics "Vharm" and "Aharm will be returned. Each value will be returned separated by a comma</p>

:FRD? Read foreground data

Syntax	:FRD?
Description	<p>The FRD commands returns results from the analyzer. The results are returned in the order in which they are displayed on the screen. Each result is a floating point number separated by a comma</p> <p>The sequence is determined by order in which results are displayed on the front panel.</p>

Measurement configuration commands

Measurement configuration commands correspond to the Measurement Configuration Menu.

:HMX:VLT/AMP Commands for configuring the display of harmonics.

Harmonics configuration

Syntax	:HMX:VLT:SEQ <value> :HMX:AMP:SEQ <value> Where <value> equals 0 for odd and even and 1 for odd only.
Description	<p>If harmonics measurements are selected (see :SEL), the PA1000 can display all harmonics, or just the odd number harmonics from the first harmonic up to the number specified.</p>
Syntax	:HMX:VLT:RNG <value> :HMX:AMP:RNG <value> Where <value> = the maximum harmonic to be display in the range of 1 to 50.

Harmonics configuration (cont.)

Description	If harmonics measurements are selected (see :SEL), the PA1000 will display all the harmonics up to the number specified by <value >. The harmonics displayed can be restricted to odd numbered harmonics only using the harmonic sequence command.
Syntax	:HMX:VLT:FOR <value> :HMX:AMP:FOR <value> Where <value> = 0 absolute values = 1 percentage values
Description	If harmonics measurements are selected (see :SEL), the PA1000 can display all harmonics (except the first) as an absolute value or as a percentage of the fundamental (first) harmonic.

:HMX:THD Commands for setting up the total harmonic distortion measurements.

Total harmonic distortion setup

Syntax	:HMX:THD:REF <value> Where <value> = 0 fundamental = 1 rms
Description	For total harmonic distortion (THD) readings (also known as the series formula), the reference on the denominator of the equation can be either the rms reading or the fundamental harmonic reading.
Syntax	:HMX:THD:SEQ <value> Where <value> = 0 for odd and even = 1 for odd only
Description	For total harmonic distortion (THD) readings (also known as the series formula), the harmonics used in the measurement can include all harmonics up to the specified number or only the odd harmonics.
Syntax	:HMX:THD:RNG <value> Where <value> = the maximum harmonic to be display in the range of 2 to 50.
Description	For total harmonic distortion (THD) readings (also known as the series formula), <value > is used to specify the maximum harmonic number used in the formula.
Syntax	:HMX:THD:DC <value> Where <value> = 0 for exclude = 1 for include
Description	For total harmonic distortion (THD) readings (also known as the series formula), the formula can either include or exclude the DC component.

:HMX:THD:FML Commands for setting up the total harmonic distortion formulas.

Total harmonic distortion setup

Syntax :HMX:THD:FML <value>

Where <value>:

= 0 — series (THD)

= 1 — difference (DF)

Description For total harmonic distortion (THD) readings (also known as the series formula), the formula can either include or exclude the DC component.

:HMX:THD:Hz Command for including or excluding THD harmonic zero.

Total harmonic distortion setup

Syntax :HMX:THD:Hz <value>

Where <value> = 0 — exclude

= 1 — include

Description For total harmonic distortion (THD) readings, the command can either include or exclude the frequency component.

Mode setup commands

The mode set up commands correspond to the Modes menu. (See page 18, *Modes*.) They are used to control how the PA1000 is configured to measure parameters in certain conditions.

:MOD Mode

Syntax :MOD:INR (inrush mode)
 :MOD:NOR (normal mode)
 :MOD:BALL (ballast mode)
 :MOD:SBY (standby power mode)
 :MOD:INT (integrator mode)

Description This command sets the mode.

Syntax :MOD?

Return format Mode number from 0 to 4.

Description This command will return a reference to the active mode.

The returned values are:

0 – Normal Mode

1 – Ballast Mode

2 – Inrush Mode

3 – Standby Power Mode

4 – Integrator Mode

:MOD:INR:ARNG Inrush current range

Syntax :MOD:INR:ARNG <value>
 <value> = 1 through 10.

Description This command sets the inrush current range.

:MOD:INR:CLR Inrush clear

Syntax :MOD:INR:CLR

Description This command clears the Apk value when in Inrush mode.

:MOD:INR:VRNG Inrush voltage range

Syntax :MOD:INR:VRNG <value>
 <value> = 1 through 7.

Description This command sets the inrush voltage range.

:INT:CLK:DATE Set date

Syntax INT:CLK:DATE xxxxxxxx
 xxxxxxxx means dd_mm_yyyy, or mm_dd_yyyy, or yyyy_mm_dd according to the Date Format settings in the Main Menu -> System Configuration -> Clock -> Date Format.

Description Sets the start date for the integrator when configured for Clock Start Method. Start date sent in current PA1000 date format.

:INT:CLK:DUR Set duration

Syntax :INT:CLK:DUR <value>
 (1.0 ≤ <value> ≤ 1,000,000)

Description Sets the duration of the integrator, in minutes, when configured for Clock Start Method.

:INT:CLK:TIME Set start time

Syntax :INT:CLK:TIME xx_xx_xx
 xx_xx_xx stands for hh_mm_ss for 24 hr time format or hh_mm_ss (A or P) for AM/PM time format.

Description Sets the start time for the integrator when configured for Clock Start Method. Start time sent in current PA1000 time format.

:INT:MAN:RUN	Start integration
Syntax	:INT:MAN:RUN
Description	Starts integration when in Manual Start Method. Requires integration mode active, manual start selected and integration not running.
:INT:MAN:STOP	Stop integration
Syntax	INT:MAN:STOP
Description	Stops integration when in Manual Start Method. Requires integration mode active, manual start selected and integration running.
:INT:RESET	Reset integration
Syntax	:INT:RESET
Description	Resets integration values. Requires integration mode active and integration not running.
:INT:START	Start method
Syntax	:INT:START <value> <value> = 0 → Manual Start Method <value> = 1 → Clock Start Method
Description	Selects either Manual Start Method or Clock Start Method.

Input setup commands

The input setup commands correspond to the Inputs menu. (See page 21, *Inputs*.) They are used to control how signal inputs to the PA1000 are channelled and controlled.

:RNG	Ranging
Syntax	:RNG:VLT AMP:FIX <range> :RNG:VLT AMP:AUT VLT = set voltage ranging AMP = set current ranging FIX = Fixed ranging AUT = auto ranging Where <range> = range number from 1 to 10.
Description	Sets the range. The range numbers for each input are defined below:

Ranging (cont.)

Range #	Volts	20 A shunt	1 A shunt	Ext. shunt
Auto				
1	10 V	0.1 A	0.002 A	—
2	20 V	0.2 A	0.004 A	—
3	50 V	0.5 A	0.01 A	—
4	100 V	1 A	0.02 A	0.0125 V
5	200 V	2 A	0.04 A	0.025 V
6	500 V	5 A	0.1 A	0.0625 V
7	1000 V	10 A	0.2 A	0.125 V
8		20 A	0.4 A	0.25 V
9		50 A	1 A	0.625 V
10		100 A	2 A	1.25 V
Syntax	:RNG:VLT AMP?			
Return	0 through 10.			
Description	Returns an index to the currently selected range. If auto range is selected, then 0 will be returned.			
Syntax	:RNG:VLT AMP:AUT?			
Return	0 through 1.			
Description	Returns 0 for fixed range and 1 for auto range.			

:SHU Shunt selection

Syntax	:SHU:INT :SHU:INT1A :SHU:EXT INT = set internal 20 A _{RMS} shunt INT1A = set internal 1 A _{RMS} shunt EXT = set external shunt
Description	Sets the shunt.
Syntax	:SHU?
Return format	0 through 2.
Description	Returns the shunt setting 0 = Internal 20 A _{RMS} shunt 1 = External 2 = 1 A _{RMS} shunt

:FSR Frequency settings

Syntax	:FSR:VLT :FSR:AMP :FSR:EXT1 VLT = set the voltage channel as the source AMP = set current channel as the source EXT1 = set external counter input 1 as the source
Description	Determines which channel is used as the frequency source/reference.
Syntax	:FSR?
Return	0 through 1
Description	Returns the currently configured frequency source The values returned correspond to: 0 = Voltage channel 1 = Current channel

:SCL Scaling

Syntax	:SCL:VLT AMP :SCL:VLT AMP VLT = Voltage channel scaling AMP = Current channel scaling Where <scale> = number from 0.0001 to 100,000.
Description	Sets the scaling factor for the voltage or current channel.
Syntax	:SCL:VLT AMP EXT? VLT = Voltage channel scaling AMP = Current channel scaling
Return	Number from 0.0001 to 100,000
Description	Returns the scaling factor for the voltage or current channel.

:INP:FILT:LPAS Low pass frequency filter

Syntax	:INP:FILT:LPAS <value> Where <value> = 0 or 1.
Description	Sets the low pass frequency filter state: <value> = 0 -> Low Pass Frequency Filter Disabled <value> = 1 -> Low Pass Frequency Filter Enabled
Syntax	:INP:FILT:LPAS?
Return	Returns the low pass frequency filter state. <value> = 0 -> Low Pass Frequency Filter Disabled <value> = 1 -> Low Pass Frequency Filter Enabled

Graph and waveform commands

:GRA:HRM:AMP:SCL Set harmonic amp scaling

Syntax GRA:HRM:AMP:SCL <value>
 <value> = 0 through 100

Description Set scaling in harmonic bar chart for Amps

:GRA:HRM:VLT:SCL Set harmonic volt scaling

Syntax GRA:HRM:VLT:SCL <value>
 <value> = 0 through 1000

Description Set scaling in harmonic bar chart for Volts

:GRA:HRM:AMP:SHW Show current bar chart

Syntax GRA:HRM:AMP:SHW

Description Shows current bar chart.

:GRA:HRM:VLT:SHW Show voltage bar chart

Syntax GRA:HRM:VLT:SHW

Description Shows voltage bar chart.

:GRA:HRM:HLT Highlight harmonic

Syntax GRA:HRM:HLT <value>
 <value> = 1 through 50

Description Highlights required harmonic

Return <value> = 0 → Watts graph disabled
 <value> = 1 → Watts graph enabled

:GRA:WAV:WAT Waveform Watt graph

Syntax :GRA:WAV:WAT <value>

Description Enables or disables the Watts graph.

Return <value> = 0 → Watts graph disabled
 <value> = 1 → Watts graph enabled

:GRA:WAV:SHW **Waveform graph**

Syntax	:GRA:WAV:SHW
Description	Shows the waveform graph.

Interface commands

Interface commands are used to set up and control the various ways of communicating with the PA1000.

:COM:IEE **GPIB configuration**

Syntax	:COM:IEE:ADDR <address> Where <address> = address in the range of 1 to 30.
Description	Sets the GPIB address for the PA1000.
Syntax	:COM:IEE:ADDR?
Return	address in the range of 1 to 30.
Description	Returns the GPIB address for the PA1000.

:COM:ETH **Return Ethernet configurations**

Syntax	:COM:ETH:SUB IP GATE? SUB = Subnet mask IP = IP address GATE = Default gateway
Return	Number in the form of v4 IP address xxx.xxx.xxx.xxx.
Description	Returns the requested information in the form of an IP address. The information returned is the current configuration. If DHCP is used as the assignment method, then the values returned would be those values assigned by the DHCP server.

:COM:ETH:STAT **Static Ethernet configuration**

Syntax	:COM:ETH:STAT <value> Where <value> = 0 or 1
Description	Determines whether the PA1000 uses a static IP address or one assigned by a DHCP server. If <value> = 0 then a DHCP server is used. If <value> = 1 then the static IP settings are used.
Syntax	:COM:ETH:STAT?
Return	0 or 1

Static Ethernet configuration (cont.)

Description	Returns whether the PA1000 uses a static IP address or one assigned by a DHCP server. If the returned value is 0 then a DHCP server is used. If the returned value is a 1 then the static IP settings are used.
Syntax	:COM:ETH:STAT:SUB IP GATE <ip value > SUB = Subnet mask IP = IP address GATE = Default gateway Where <ip value> is in the format xxx.xxx.xxx.xxx.
Description	These commands are used to set the statically assigned IP values for the PA1000.
Syntax	:COM:ETH:STAT:SUB IP GATE? SUB = Subnet mask IP = IP address GATE = Default gateway
Return	IP address in the format xxx.xxx.xxx.xxx
Description	These commands are used to return the statically assigned IP values for the PA1000.

:COM:ETH:MAC Ethernet MAC Address

Syntax	:COM:ETH:MAC? MAC = MAC address
Return	MAC address in the format of 12 HEX characters.
Description	Used to return the MAC address on the Ethernet controller. The MAC address would be of the form: 0x0019B9635D08.

System configuration commands

The System configuration commands correspond to the System Configuration front panel menu screen. (See page 25, *System configuration*.)

:BLK Blanking

Syntax	:BLK:ENB - blanking enabled. :BLK:DIS - blanking disabled.
Return	None
Description	With blanking enabled, the analyzer will return a zero when the measured signal is less than a certain percentage of the bottom range. If the blanked channel is also used in another result, for example, Watts, then that value will also be blanked.
Syntax	:BLK?

Blanking (cont.)

Return	0 = disabled; 1 = enabled
Description	Returns the status of blanking.

:AVG Averaging

Syntax	:AVG <value> Where <value> is 0 or 1; 0 = disabled; 1 = enabled
Return	None
Description	The command is used to enable or disable averaging.
Syntax	:AVG?
Return	0 = disabled; 1 = enabled
Description	Returns the units averaging value.

:SYST:ZERO Auto zero

Syntax	:SYST:ZERO <value> Where <value> is 0 for disable, 1 for enable.
Return	None
Description	Sets whether the auto zero function for the channels is enabled or disabled.
Syntax	:SYST:ZERO?
Return	0 = disabled, 1 = enabled.

:SYST:DATE System date

Syntax	:SYST:DATE? :SYST:SET:DATE <date value> :SYST:FOR:DATE <date format> Where <date value> is the new date in the selected format and <date format> is the date format.
Return	Date formatted in the way specified by the user separated by “-”.
Description	The :SYST:DATE? Command will return the date on the analyzer in the format specified by the user. The user can choose one of 3 formats: <date format> = 0 – mm-dd-yyyy <date format> = 1 – dd-mm-yyyy <date format> = 2 – yyyy-mm-dd You can also set the date on the analyzer using the :SYST:SET:DATE command. In this case, the <date value> should be in the format specified. For example, if the specified format were 0 (mm-dd-yyyy), then the command would be: :SYST:SET:DATE 10_31_2013

:SYST:TIME System time

Syntax	:SYST:TIME? :SYST:SET:TIME <time value > :SYST:FOR:TIME <time format> Where <time value> is the new time in the selected format and <time format> is the time format.
Return	Time formatted in the way specified by the user, hours and minutes and seconds separated by “_”. For example, 01_34_22P for 12 hour or 13_34_22 for 24 hour.
Description	The :SYST:TIME? command will return the time on the analyzer in the format specified by the user. The user can choose one of 3 formats: <time format> = 0 – 12 Hour hh:mm:ss A/P <time format> = 1 – 24 Hour hh:mm:ss The user can also set the time on the analyzer using the :SYST:SET:TIME command. In this case, the <time value> should be in the formatted specified. For example, if the specified format were 0 (12 Hour), then the command would be: :SYST:SET:TIME 08_32_20 P For 12 hour clock, A should be used for AM and P for PM.

User configuration commands

These commands relate to the User Configuration menu item.

:CFG: User configurations

Syntax	:CFG:LOAD <value> :CFG:SAVE <value> Where: <value> is user configuration 1 through 5 for saving and 0 through 5 for loading. 0 is the default configuration.
Description	These commands will be used to load and save one of the 5 user configurations.
Return	None.

View commands

Display

Syntax	:DSP:Z04 :DSP:Z14
Description	:DSP:Z04 displays the 4 results screen :DSP:Z14 displays the 14 results screen

Sending and receiving commands

As stated before, there are many ways in which to send commands to the PA1000, but there are some common rules for all methods:

- All instructions should be terminated with a line feed (ASCII 10) character.
- All returned information will be terminated by a line feed (ASCII 10) character.
- Only one instruction can be sent at a time. ":SEL:VLT;:SEL:AMP" is not a valid command.
- For all commands that configure the unit, allow 0.5 seconds between each command or use flow control to wait until the next command is sent.
- The running of auto-zero, which happens every 1 minute, will result in no new results for approximately 1 second. For this reason auto-zero can be disabled.

NOTE. When utilizing communications via the Ethernet interface on the PA1000, all communications will be responded to with a carriage return character, i.e. ASCII CR (0x0D). In the examples below the carriage return character is represented by "[CR]".

Tip. If using Visual Studio or Lab-View you can utilize the 'Flush, In-buffer' command to quickly and simply remove the carriage return from the input buffer. This can be set-up as a discipline in the software to occur after every read and write command sent.

Example 1. User sends a query to the PA1000 to determine the status of the shunt. The PA1000 will respond with a CR added to the end of the string;

USER: ":SHU?"

PA1000: "0[CR]"

The PA1000 responds as normal with a CR character added to the end of the string.

Example 2. User sends a command to the PA1000 to disable blanking and the PA1000 responds with a CR character;

USER: ":SHU:INT"

PA1000: "[CR]"

The PA1000 responds with a CR character.

Utilizing all other communication methods the PA1000 does not reply with a CR to every communication.

Communications examples

Basic selection and returning of result

The results are returned using the FRD command. This returns the results that are shown on the screen, in the order in which they appear on the screen. As results are selected using comms, the results are added to the bottom of the list, with the exception of harmonics, which always appear at the end of the list.

```
:SEL:CLR           clears all results
:SEL:VLT
:SEL:AMP
:SEL:FRQ
:SEL:WAT
:SEL:VAS
:SEL:VAR
:SEL:PWF
:SEL:VPK+
:SEL:APK+
:FRD?              Returns Vrms, Arms, Frequency, Watts, VA,
                   Var, power factor, Vpeak + and Vpeak- in
                   floating point format.
:FRF?              Returns the results selected for confirmation
                   using the label that appears on the display.
                   In this case will return, "Vrms, Arms, Freq,
                   Watt, VA, Var, PF, Vpk+, Apk+
```

Returning results repeatedly

The PA1000 updates the results at the specified update rate. To return results as soon as they are available, set up the DSE register to enable bit 1, the New Data Available (NDV) bit. Then read the DSR register using the ":DSR?" command until it indicates that there is new data available, and then send a ":FRD?" command to get selected results.

```
":DSE 2" // This enables the NDV bit.
```

```
While strDSR <> "2"
```

```
    ":DSR?"
```

```
    strDSR = received data
```

```
WEND
```

```
":FRD?"
```

```
Receive results
```

Harmonics To return harmonics, first the number of harmonic and the scope need to be selected and then they need to be added to the list of results on the display.

:HMX:VLT:SEQ 0	Select odd and even harmonics (use 1 to select odd harmonics only).
:HMX:VLT:RNG 9	Return all harmonic from 1 to 9.
:SEL:VHM	Add Voltage harmonics to the list.

Now, assuming :SEL:CLR has not been issued after example 1, then the following results would be returned by :FRD?

V_{RMS} , A_{RMS} , Freq, Watt, VA, Var, PF, Vpk+, Apk+, Vh1 Mag, Vh1 phase, Vh2 Mag, Vh2 phase, Vh9 Mag, Vh9 phase.

Software

PWRVIEW PC software

PWRVIEW is a supporting software application for Windows PCs that compliments and extends the functionality of the PA1000. PWRVIEW is a free download from www.tektronix.com that enables you to do the following:

- Communicate with the PA1000 over any of the instrument communication ports
- Change instrument settings remotely
- Transfer, view, and save measurement data in real-time from the instrument, including waveforms, harmonic bar charts, and plots
- Log measurement data over a period of time
- Communicate with and download data from multiple PA1000 instruments simultaneously
- Create formulae for the calculation of power conversion efficiency and other values
- Export measurement data to .csv format for import into other applications
- Automate instrument setup, data collection, and report generation for key applications with just a few clicks, using wizard-driven interfaces
- Perform automated full compliance testing for Low Power Standby per IEC62301, Edition 2

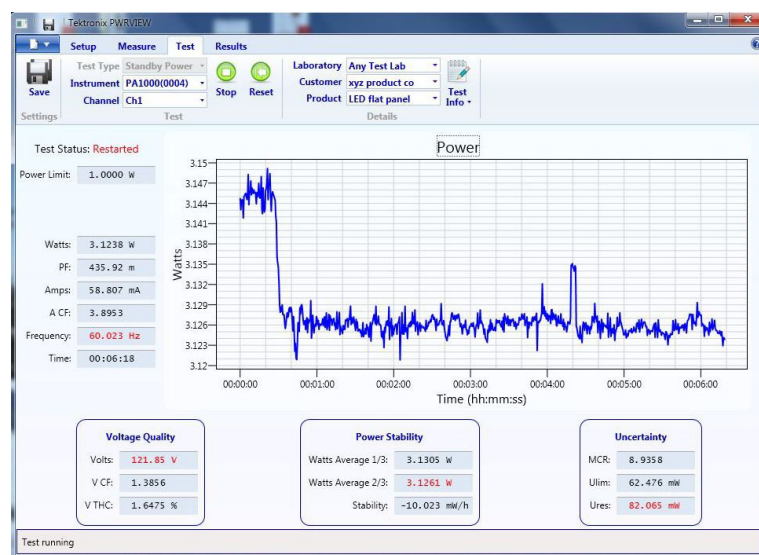

Figure 17: PWRVIEW application

PA1000 firmware update utility

The PA1000 has been designed so that you can add new features by updating the firmware within the product. The firmware is updated by using a free PC software program, which can be found on the PA1000 section of the Tektronix web site (www.tektronix.com). Simply download the software and install it on your PC.

The download software is compliant with the Windows 7 operating system.

Once installed, run the software to get the main screen:

The software supports the downloading of firmware via USB.

Before downloading code, you can confirm that the communications interface is working correctly by clicking on the USB Comms Test button. This will return the serial number, firmware version and hardware version of the PA1000.

Next, you need to point the software to both the main firmware file and the help file. These files will be named “PA1000Firmware.bin” and “PA1000_LanguagePack_English.txt” respectively. The file can also be found on the Tektronix website, on the PA1000 page.

Finally, when ready, click on “Press to Load Firmware”.



CAUTION. *Do not remove power from the PA1000 during the download.*

During certain sections of the download, the PA1000 screen will go blank. Once the download is complete, the PA1000 will restart automatically and will then be ready for use.

Specifications

Measurement channel

- Voltage connections**
- Measurements to 600 V_{RMS}, DC and 10 Hz to 1 MHz, continuous
 - Differential input impedance: 1 Mohm in parallel with 22 pF
 - High and low input impedance to ground: 36 pF (typical)

- 20 A current connection**
- Measurements to 100 A_{peak}, 20 A_{RMS}, DC and 10 Hz to 1 MHz, continuous
 - 50 A_{RMS} for 1 second non-repetitive
 - 12.5 mΩ
 - High and low input impedance to ground: 62 pF (typical)

- 1 A current connection**
- Measurements to 2 A_{peak}, 1 A_{RMS}, DC and 10 Hz to 1 MHz, continuous
 - 2 A_{RMS} for 1 second non-repetitive
 - 0.6 Ω
 - High and low input impedance to ground: 62 pF (typical)
 - Protection = 1 x F1AH, 600 volt fuse

- External current connection**
- Measurements to 1.25 V_{peak}, DC and 10 Hz to 1 MHz, continuous
 - 50 V_{peak} for 1 second
 - High and low input impedance to ground: 62 pF (typical)

Power input

- AC input voltage = 100 – 240 V, 50/60 Hz
- Protection = 2 x T1AH, 250 V, 5x20 mm fuses
- Consumption = 25 VA max.

Mechanical and environmental

Dimensions (typical)	<ul style="list-style-type: none">■ Height: 102 mm (4.0”) with feet■ Width: 223 mm (8.8”) without handle, 260 mm (10.2”) with handle■ Depth: 285 mm (11.2”) without handle, 358 mm (14.1”) with handle
Weight (typical)	3.2 Kg (7.05 lb) with handle
Dielectric strength	<ul style="list-style-type: none">■ Mains supply inlet (Live + Neutral to earth): 1.5 kVAC■ Voltage measurement inputs: 1 kV_{peak} to earth■ Current measurement inputs: 1 kV_{peak} to earth
Storage temperature	-20 °C to +60 °C (-4 °F to 140 °F)
Operating temperature	0 °C to 40 °C (32 °F to 104 °F)
Maximum operating altitude	2000 M (6562 ft)
Maximum relative humidity	80% for temperatures up to 31 °C (88 °F) decreasing linearly to 50 % relative humidity at 40 °C (104 °F)

Communication ports

The PA1000 is fitted with IEEE488 / GPIB, USB host, USB client and Ethernet ports as standard.

IEEE 488 / GPIB

The IEEE 488 port is compatible with 488.1. Standard GPIB cables will work with the PA1000.

Pin	Signal name	Pin	Signal name
1	Data 1	13	Data 5
2	Data 2	14	Data 6
3	Data 3	15	Data 7
4	Data 4	16	Data 8
5	End or Identify (EOI)	17	Remote Enable (REN)
6	Data Valid (DAV)	18	GND
7	Not Ready For Data (NRFD)	19	GND
8	Not Data Accepted (NDAC)	20	GND
9	Interface Clear (IFC)	21	GND
10	Service Request (SRQ)	22	GND
11	Attention (ATN)	23	GND
12	Shield Ground	24	GND

USB host

- One port on the front.
- 250 mA, +5 V supply.

USB flash drive requirements:

- The USB flash drive must be formatted with FAT12, FAT16 or FAT32 file systems.
- Sector size must be 512 bytes. Cluster size up to 32 kB.
- Only Bulk Only Mass Storage (BOMS) devices which support the SCSI or AT command sets are supported. For more information on BOMS devices refer to Universal Serial Bus Mass Storage Class – Bulk Only Transport Rev. 1.0, published by the USB Implementers Forum.

Pin	Description
1	+5 V (output)
2	D- (input and output)

Pin	Description
3	D+ (input and output)
4	0V (output)

USB peripheral

- USB 2.0 compatible. Will work with any USB 2.0 system.
- Test and Measurement class device
- Full Speed (12 Mbits/sec).

Pin	Description
1	VBus (input)
2	D- (input and output)
3	D+ (input and output)
4	0 V (input)

Ethernet port

- IEEE 802.3 compatible, 10Base-T
- Connector: RJ-45 with Link and Activity indicators
- TCP/IP connection on port 5025

Pin	Signal name
1	Tx+
2	Tx-
3	Rx+
4	Common
5	Common
6	Rx-
7	Common
8	Common

Status indicator LEDs:

- Green – Connection established
- Yellow – Data activity

Measured parameters

Table 5: Phase measurements

Abbreviation	Description	Units	Formula
V _{RMS}	RMS Voltage	Volt (V)	$V_{RMS} = \sqrt{\frac{1}{T} \int_0^T v_1^2 dt}$
A _{RMS}	RMS Current	Amp (A)	$A_{RMS} = \sqrt{\frac{1}{T} \int_0^T i_1^2 dt}$
F	Frequency	Hertz (Hz)	
W	True Power	Watt (W)	$W = \frac{1}{T} \int_0^T v_i i_i dt$
PF	Power Factor		$PF = \left[\frac{Watt}{V_{rms} \times A_{rms}} \right]$
VA	Apparent Power	Volt-Amps (VA)	$VA = [V_{rms} \times A_{rms}]$
VAr	Reactive Power	Volt-Amps Reactive (VAr)	$VAr = \sqrt{(VA)^2 - W^2}$
V _{PK +}	(+)ve Peak Voltage	Volt (V)	$max \{v\}$
V _{PK -}	(-)ve Peak Voltage	Volt (V)	$min \{v\}$
A _{PK -}	(+)ve Peak Current	Amp (A)	$max \{i\}$
A _{PK +}	(-)ve Peak Current	Amp (A)	$min \{i\}$
V _{DC}	DC Voltage	Volt (V)	$V_{DC} = \frac{1}{T} \int_0^T v dt$
A _{DC}	DC Current	Amp (A)	$A_{DC} = \frac{1}{T} \int_0^T i dt$
V _{CF}	Voltage Crest Factor		$CF = \frac{Peak Value}{RMS Value}$
A _{CF}	Current Crest Factor		$CF = \frac{Peak Value}{RMS Value}$
V _{DF}	Voltage Total Harmonic Distortion	%	$\frac{\sqrt{(H0^2)+H2^2+H3^2+H4^2+H5^2+....}}{REF}$
V _{DF}	Voltage Distortion Factor	%	$\frac{\sqrt{Vrms^2-H1^2}}{REF}$

Table 5: Phase measurements (cont.)

Abbreviation	Description	Units	Formula
A _{DF}	Current Total Harmonic Distortion	%	$\frac{\sqrt{(H0^2)+H2^2+H3^2+H4^2+H5^2+....}}{REF}$
A _{DF}	Current Distortion Factor	%	$\frac{\sqrt{Arms^2-H1^2}}{REF}$
Z	Impedance	Ohm (θ)	$Z = \frac{V_{fund}}{I_{fund}}$
R	Resistance	Ohms (Ω)	$R = \pm [Z_{err} \times \cos \theta] \pm [Z \times (\cos \theta - \cos(\theta \pm Vh1ph.err \pm Ah1ph.err))]$ $R = \frac{Vf}{Af} \times \cos \theta (\theta = V phase - A phase)$
X	Reactance	Ohms (Ω)	$X = \pm [Z_{err} \times \sin \theta] \pm [Z \times (\sin \theta - \sin(\theta \pm Vh1ph.err \pm Ah1ph.err))]$ $X = \frac{Vf}{Af} \times \sin \theta (\theta = V phase - A phase)$
V _{h_n}	Voltage harmonic n	Volt (V)	$Mag = \sqrt{(Vh_n.r^2 + Vh_n.q^2)}$ $Phase = \tan^{-1} \left(\frac{Vh_n.q}{Vh_n.r} \right)$
A _{h_n}	Current harmonic n	Amp (A)	$Mag = \sqrt{(Ah_n.r^2 + Ah_n.q^2)}$ $Phase = \tan^{-1} \left(\frac{Ah_n.q}{Ah_n.r} \right)$

¹ f = real part of fundamental V or I fundamental
q=imaginary or quadrature part of V or I
V and I fundamental are complex numbers in the form r+jq

Power polarity

Table 6: Power polarity

Measurement	-180 ° to -90 °	-90 ° to 0 °	0 ° to +90 °	+90 ° to +180 °
Watts	-	+	+	-
PF	-	+	+	-
VAr	+	+	+	+

Measurement accuracy

The table below lists the formulae for calculating the accuracy specification for each measurement.

In the equations below:

- It is assumed the waveform measured is a sine wave.
- F is the frequency measured in kHz.
- Fh is the harmonic frequency in kHz.
- hn is the harmonic number
- V is the voltage measured in Volts.
- I is the current measured in Amps.
- Θ is the phase angle in degrees (i.e. phase of the current with reference to the voltage).
- $Z_{EXT} = 12.5 \text{ m}\Omega$ when the 20 A shunt is selected and $0.6 \text{ }\Omega$ when the 1 A shunt is selected.

All specifications are valid $23 \text{ }^\circ\text{C} \pm 5 \text{ }^\circ\text{C}$.

Temperature coefficient $\pm 0.02\%$ of reading / $^\circ\text{C}$, 0 to $18 \text{ }^\circ\text{C}$, 28 to $40 \text{ }^\circ\text{C}$.

Parameter	Specification
Voltage – V_{RMS}, V_{RMS}, V_{DC}	
Ranges	1000 V, 500 V, 200 V, 100 V, 50 V, 20 V, 10 V_{peak}
V_{RMS} 45-850 Hz Accuracy	$\pm 0.05\%$ of reading $\pm 0.05\%$ of range $\pm 0.05 \text{ V}$
V_{RMS} 10 Hz – 45 Hz, 850 Hz – 1 MHz, Accuracy (typical)	$\pm 0.1\%$ of reading $\pm 0.1\%$ of range $\pm (0.02 * F)\%$ of reading $\pm 0.05 \text{ V}$
DC Accuracy	$\pm 0.1\%$ of reading $\pm 0.1\%$ of range $\pm 0.05 \text{ V}$
Effect of Common Mode (typical)	100 V, 100 kHz <500 mV
Voltage – Harmonic magnitude and phase (typical)	
10 Hz – 1 MHz Accuracy	$\pm 0.2\%$ of reading $\pm 0.1\%$ of range $\pm (0.04 * Fh)\%$ of reading $\pm 0.05 \text{ V}$
Phase	$\pm 0.1 \pm [0.01 * (V_{range} / V_{reading})] \pm (0.2 / V_{range}) \pm (0.005 * Fh)$
Voltage – V_{pk+}, V_{pk-} crest factor	
Peak Accuracy	$\pm 0.5\%$ of Reading $\pm 0.5\%$ of Range + $(0.02 * F)\%$ of reading $\pm 0.5 \text{ V}$
CF Accuracy	$\left[\frac{V_{PKerror}}{V_{PK}} + \frac{V_{RMSerror}}{V_{RMS}} \right] \times V_{CF}$ (valid for a crest factor of 1 to 10)
Current – A_{RMS}, A_{DC}	
20 A Shunt Ranges	100 A, 50 A, 20 A, 10 A, 5 A, 2 A, 1 A, 0.5 A, 0.2, 0.1 A_{peak}

Parameter	Specification
1 A Shunt Ranges	2 A, 1 A, 0.4 A, 0.2 A, 0.1 A, 0.04 A, 0.02 A, 0.01 A, 0.004, 0.002 A _{peak}
External Shunt Ranges	1.25 V, 0.625 V, 0.25 V, 0.125 V, 0.0625 V, 0.025 V, 0.0125 V _{peak}
A _{RMS} 45-850 Hz Accuracy	±0.05% of reading ±0.05% of range ± (50 uV / Z _{ext})
10 Hz – 45 Hz, 850 Hz – 1 MHz Accuracy (typical)	±0.1% of reading ±0.1% of range ± (0.02 * F)% of reading ± (50 uV / Z _{ext})
DC Accuracy	±0.1% of reading ±0.1% of range ± (100 uV / Z _{ext})
Effect of Common Mode (typical)	100 V, 100 kHz, 20 A shunt <15 mA 100 V, 100 kHz, 1 A shunt < 500 uA 100 V, 100 kHz, external shunt < 40 mV
Current – Harmonic magnitude and phase (typical)	
10 Hz - 1 MHz	±0.2% of reading ±0.1% of range ±(0.04 * Fh)% of reading ±(50 μV / Z _{ext})
Phase	±0.1 ±[0.01 * (A _{range} / A _{reading})] ±(0.002 / (A _{range} *Z _{ext})) ±(0.005 * Fh)
Current – A_{pk+}, A_{pk-}, crest factor	
Peak Accuracy	±0.5% of Reading ± 0.5% of Range + (0.02 * F)% of reading ±(0.3 mV / Z _{ext})
CF Accuracy	$\left[\frac{A_{PK}error}{A_{PK}} + \frac{A_{RMS}error}{A_{RMS}} \right] \times A_{CF}$ (valid for a crest factor of 1 to 10)
Current – peak inrush accuracy (typical)	
100 A _{peak} range	2% of range ±20 mA
Frequency	
10 Hz to 20 kHz	0.1% of reading, with the peak of the signal extending 10% above and 10% below the DC level.
20 kHz to 1 MHz	0.1% of reading, with the peak of the signal extending 25% above and 25% below the DC level. Maximum frequency is 22 kHz when frequency source is set to current.
Power – W, VA, VAR, and PF	
W Accuracy	
PF ≠ 1	$(V_{rms}acc. \times A_{rms} \times PF) \pm (A_{rms}acc. \times V_{rms} \times PF) \pm (V_{rms} \times A_{rms} \times (\cos \theta - \cos \{\theta \pm (Vh1_{pherr} \pm Ah1_{pherr})\}))$
PF = 1	±0.075% of Reading ± 0.075% of Range
VA Accuracy	$(V_{rms}acc. \times A_{rms}) + (A_{rms}acc. \times V_{rms})$
VA _r Accuracy (typical)	$\sqrt{([VA \pm VA error]^2 - [W \pm W error]^2)} - \sqrt{(VA^2 - W^2)}$
PF Accuracy	$((Cos\theta - Cos \{\theta \pm (Vh1_{ph.err.} \pm Ah1_{ph.err.})\})) \pm 0.002$
Distortion – DF and THD (typical)	
DF Accuracy	$\left[\frac{RMS_{error}}{RMS} + \frac{h1_{Mag}error}{h1_{Mag}} \right] \div DF$
THD Accuracy	$\left[\frac{h2_{Mag}error}{h2_{Mag}} + \frac{h3_{Mag}error}{h3_{Mag}} + \frac{h4_{Mag}error}{h4_{Mag}} + ...etc \right] \times THD$

Parameter	Specification
Impedance – Z, R and X (typical)	
Z Accuracy	$\left[\frac{V_{RMSerror}}{V_{RMS}} + \frac{A_{RMSerror}}{A_{RMS}} \right] \times Z$
R Accuracy	$\left[\frac{V_{h1magerror}}{V_{h1MAG}} + \frac{A_{h1Magerror}}{A_{h1MAG}} + \left(\tan \theta \times (V_{h1Pherror} + A_{h1Pherror}) \times \frac{\pi}{180} \right) \right] \times R$
X accuracy	$\left[\frac{V_{h1MAGerror}}{V_{h1MAG}} + \frac{A_{h1MAGerror}}{A_{h1MAG}} + \left(\frac{V_{h1Pherror} + A_{h1Pherror}}{\tan \theta} \times \frac{\pi}{180} \right) \right] \times X$

NOTE. Z_{ext} is the external shunt impedance used and must be less than or equal to 10 Ohms.

All the stated accuracies are based upon a minimum of a 30-minute warm up period.

If no frequency is measured, then the signal is considered DC for the purpose of accuracy.

Specifications are valid only when applicable voltage and current inputs are > 10% of range. The exception is harmonics where the specification is valid when the magnitude of the harmonic is >2% of range.

Index

A

Auto Zero, 25

B

Before you begin - safety, 4

Breakout Box

connecting, 10

C

Choosing measurements to display, 13

Clock setup, 25

Command listing, 37

Communication ports, 60

Configuration, 16

Connect a current transformer, 28
current scaling, 28

Connect a resistive shunt, 29

Connect a transducer

with a voltage output, 30

Connect a voltage transducer, 31
voltage scaling, 31

Connect a voltage transformer, 31
voltage scaling, 31

Connecting

Breakout Box, 10

Connecting signals, 27

Connecting to the product under test, 9

Connection sequence, 5

Controls and connectors, 7

D

Data logging, 14

storage and format, 14

Default measurements, 12

Distortion setup, 25

E

Examples

communications, 54

harmonics, 55

return results repeatedly, 54

select and return result, 54

F

Firmware

update utility, 57

Front panel

controls and connectors, 7

G

GPIO commands, 37

:AVG, 51

:BLK, 50

:CAL:DATE?, 39

:CFG:USER, 52

*CLS, 37

:COM:ETH, 49

:COM:ETH:MAC, 50

:COM:ETH:STAT, 49

:COM:IEE, 49

communications

examples, 54

:DSE, 39

:DSE?, 39

:DSP, 52

:DSR?, 39

:DVC, 39

*ESE, 38

*ESE?, 38

*ESR?, 38

:FRD?, 41

:FRF?, 41

:FSR, 47

:GRA:HRM:AMP:SCL, 48

:GRA:HRM:AMP:SHW, 48

:GRA:HRM:HLT, 48

:GRA:HRM:VLT:SCL, 48

:GRA:HRM:VLT:SHW, 48

:GRA:WAV:SHW, 49

:GRA:WAV:WAT, 48

graph and waveform, 48

harmonics, 55

:HMX:THD:FML, 43

:HMX:THD:Hz, 43

:HMX:VLT/AMP, 41

:HMX:VLT?AMP:THD, 42

*IDN?, 37

:INP:FILT:LPAS, 47

input setup, 45

:INT:CLK:DATE, 44

:INT:CLK:DUR, 44

:INT:CLK:TIME, 44

:INT:MAN:RUN, 45

:INT:MAN:STOP, 45

:INT:RESET, 45

:INT:START, 45

interface, 49

measurement

configuration, 41

measurement reading, 40

measurement selection, 40

:MOD, 43

:MOD:INR:ARNG, 44

:MOD:INR:CLR, 44

:MOD:INR:VRNG, 44

mode setup, 43

return results repeatedly, 54

:RNG, 45

*RST, 38

:SCL, 47

:SEL, 40

select and return result, 54

sending and receiving, 53

:SHU, 46

*STB?, 38

:SYST:DATE, 51

:SYST:TIME, 52

:SYST:ZERO, 51

system configuration, 50

unit information

commands, 39

user configuration, 52

Graphs and waveforms
 harmonic bar chart, 23
 integration graph, 23
 waveforms, 23

H

Harmonics setup, 25

I

IEEE 488.2
 standard commands, 37
 status commands, 37

Input

 current, 27
 external current, 27
 overview, 27
 voltage, 27

Inputs, 21

 averaging, 22
 blanking, 22
 fixed/auto ranging, 21
 frequency filter, 21
 frequency source, 21
 scale, 21
 shunts, 22

Installation, 4

Interfaces, 24

 Ethernet configure, 24
 GPIB address, 24

Introduction

 basic features, 1

K

Key shortcuts, 7

M

Measurements, 13
 default, 12

Menu keys, 13

Menu system, 17

 main menu, 17
 menu items, 17
 navigation, 17

Modes, 18

N

Navigating the menu system, 13

P

Power on, 6

Power polarity, 63

Printing, 15

R

Rear panel

 connectors, 8

Remote operation, 33

 interfacing with Ethernet
 systems, 33

 interfacing with GPIB
 systems, 34

 interfacing with USB
 systems, 33

S

Software, 56

 PWRVIEW PC, 56

Specifications, 58

 communications ports, 60

 Ethernet port, 61

 IEEE 488/GPIB, 60

 USB host, 60

 USB peripheral, 61

 measured parameters, 62

 measurement accuracy, 64

 measurement channel, 58

 1 A current

 connection, 58

 20 A current

 connection, 58

 external current

 connection, 58

 voltage connections, 58

 mechanical and

 environmental, 59

 dielectric strength, 59

 dimensions, 59

 humidity, 59

 maximum operating

 altitude, 59

 operating temperature, 59

 storage temperature, 59

 weight, 59

 power supply, 58

Status reporting, 34

 display data status enable
 register, 36

 display data status register, 35

 standard event status enable
 register, 36

 standard event status

 register, 36

 status byte, 34

 status byte register, 35

System configuration, 25

 Auto Zero, 25

U

Unit configuration, 16, 26

USB Flash Drive

 requirements, 15, 60

User configuration, 26